

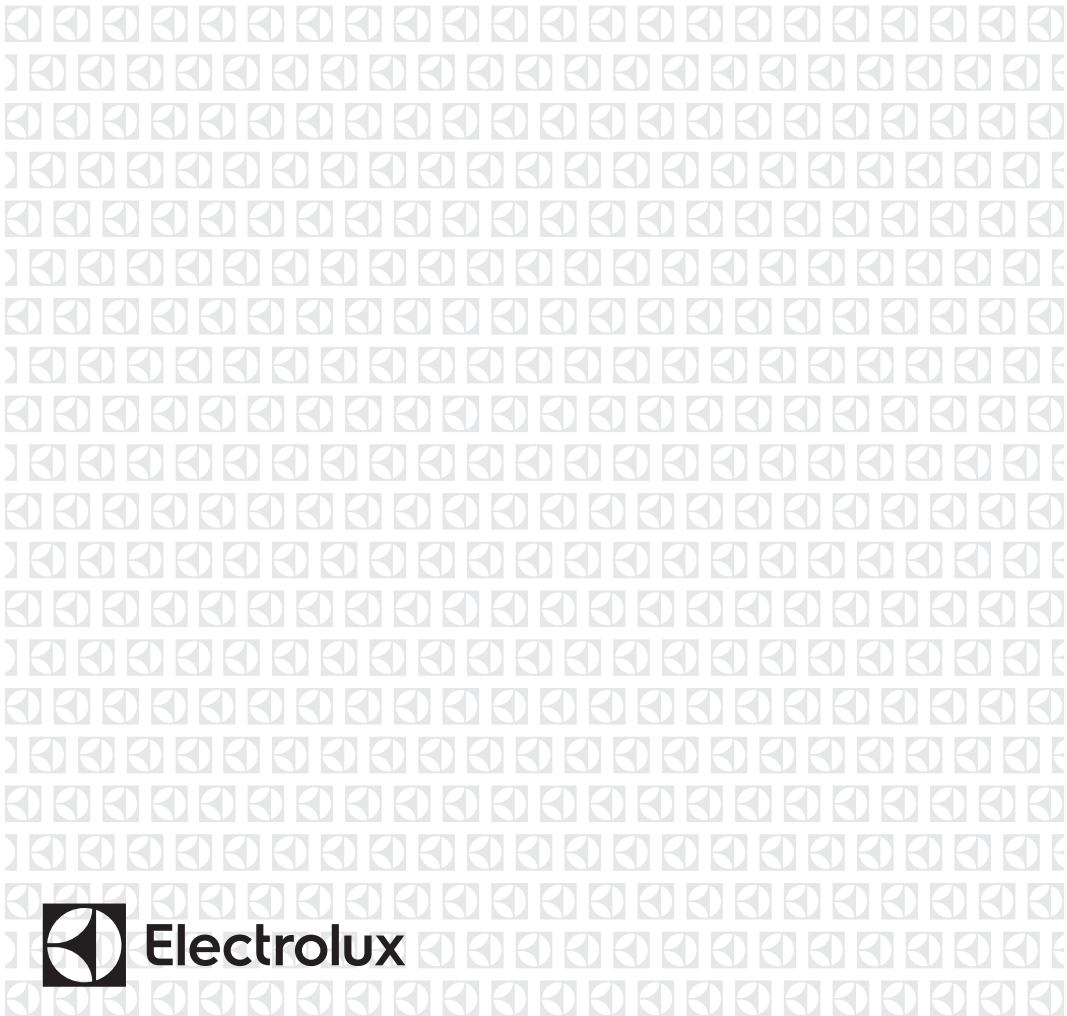

---

<b>EN</b>	Washing Machine	<b>User Manual</b>	2
<b>MS</b>	Mesin Basuh	<b>Manual Pengguna</b>	34
<b>ZH</b>	洗衣机	<b>用户手册</b>	68



## WE'RE THINKING OF YOU

Thank you for purchasing an Electrolux appliance. You've chosen a product that brings with it decades of professional experience and innovation. Ingenious and stylish, it has been designed with you in mind. So whenever you use it, you can be safe in the knowledge that you'll get great results every time. Welcome to Electrolux.



**Visit our website to:**



Get usage advice, brochures, trouble shooter, service information, buy accessories & spare parts, online product registration : **www.electrolux.com**

## CUSTOMER CARE AND SERVICE

We recommend the use of original spare parts. When contacting Service, ensure that you have the following data available. The information can be found on the rating plate. Model, PNC, Serial Number.

-  Warning / Caution-Safety information.
-  General information and tips
-  Environmental information.

Subject to change without notice.

## CONTENTS

<b>1. SAFETY INFORMATION</b>	
1.1 Conditions Of Use .....	4
1.2 Child Safety .....	4
1.3 Child Safety Device (Door Block Button) .....	5
1.4 General Safety .....	5
1.5 Installation .....	6
1.6 Use .....	6
<b>2. PRODUCT DESCRIPTION</b>	
2.1 Parts .....	7
2.2 Product Feature .....	8
2.3 Accessories .....	9
<b>3. CONTROL PANEL</b>	
3.1 Control Panel Description .....	10
3.2 Display .....	10
3.3 Program Chart .....	11
3.4 Program Options Compatibility .....	12
3.5 Options .....	12
3.6 Settings .....	14
3.7 Start/Pause (▷  ) and Add Clothes (↺) Touchpad .....	14
<b>4. BEFORE FIRST USE</b> .....	15

# CONTENTS

<b>5. DAILY USE</b>	
5.1 Loading The Laundry.....	15
5.2 Using Detergent And Additives .....	16
5.3 Options Setting .....	17
5.4 Starting A Cycle.....	17
5.5 Interruption Of A Program .....	17
5.6 Changing A Program .....	17
5.7 Changing The Options .....	17
5.8 Opening The Door.....	17
5.9 At The End Of The Program .....	18
5.10 When The Washing Program Is Completed, But There Is Water In The Drum .....	18
5.11 AUTO Off Mode .....	18
<b>6. WASHING HINTS</b>	
6.1 Sorting The Laundry .....	19
6.2 Temperatures.....	19
6.3 Before Loading The Laundry.....	19
6.4 Maximum Loads.....	19
6.5 Removing Stains.....	19
6.6 Detergents Type And Quantity Of Detergent .....	20
<b>7. INTERNATIONAL WASH CODE SYMBOLS .....</b>	<b>21</b>
<b>8. CARE AND CLEANING</b>	
8.1 External Cleaning .....	21
8.2 Descaling .....	21
8.3 After Each Wash .....	21
8.4 Maintenance Wash With “Tub Clean” Program .....	22
8.5 Cleaning The Dispenser Drawer.....	22
8.6 Cleaning The Drawer Recess .....	22
8.7 Cleaning The Pump.....	22
8.8 Cleaning The Water Inlet Filter .....	24
8.9 Frost Precautions.....	25
<b>9. TROUBLESHOOTING</b>	
9.1 Possible Failures .....	26
9.2 Emergency Door Opening .....	28
<b>10. TECHNICAL DATA .....</b>	<b>29</b>
<b>11. INSTALLATION</b>	
11.1 Unpacking .....	30
11.2 Positioning .....	31
11.3 Water Inlet .....	32
11.4 Water Drainage .....	32
11.5 Electrical Connection .....	33
<b>12. ENVIRONMENT CONCERNS</b>	
12.1 Packaging Materials .....	33
12.2 Old Machine.....	33
12.3 Ecological Hints .....	33

# 1. SAFETY INFORMATION

## 1.1 Conditions Of Use

This appliance is intended to be used in household and similar applications such as:

- Farm houses
- By clients in serviced apartments, holiday apartments and residential type environments.

In the interest of your safety and to ensure the correct use, before installing and first using the appliance, read this user manual carefully, including its hints and warnings.

To avoid unnecessary mistakes and accidents, it is important to ensure that all people using the appliance are thoroughly familiar with its operation and safety features.

Save these instructions and make sure that they remain with the appliance if it is moved or sold, so that everyone using it through its life will be properly informed on appliance use and safety.

## 1.2 Child Safety

- This washing machine is not intended for use by young children or infirm persons without supervision.
- Young children should be supervised to ensure that they do not play with the appliance.
- The packaging components (e.g. plastic film, polystyrene) can be dangerous to children - danger of suffocation! Keep them out of children's reach.
- Keep all detergents in a safe place out of children's reach.

- Make sure that children or pets do not climb into the drum.
- This machine is provided with child safety lock option (🔒) to prevent children playing with the control panel. (see page 14)

### 1.3 Child Safety Device (Door Block Button)

When you activate this device, you cannot close the door. This prevents children or pets being locked in the drum.

- To activate this device, rotate the button (WITHOUT pressing it) inside the door clockwise until it stops. If necessary use a coin.

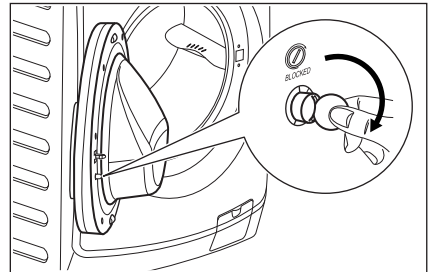

- To disable this device and restore the possibility of closing the door, rotate the button counter-clockwise until the groove is vertical.

---

### 1.4 General Safety

- It is dangerous to alter the specifications or attempt to modify this product in any way.
- During high temperature wash program the door glass may get hot. Do not touch it!
- Make sure that small pets do not climb into the drum. To avoid this, please check inside the drum before using the appliance.
- Any objects such as coins, safety pins, nails, screws, stones or any other hard, sharp material can cause extensive damage and must not be placed into the machine.
- Wash small items such as socks, laces, washable belts etc in a washing bag or pillow case as it is possible for such items to slip down between the tub and the inner drum.
- Only use manufacturer's recommended quantities of fabric softener and detergent. Damage to the fabric or appliance can occur if you exceed the recommended amount.
- Do not use your washing machine to wash articles with whalebones, material without hems or torn material.

- Always unplug the appliance and turn off the water supply after use, clean and maintenance.
- This appliance is not intended for use by persons (including children) with reduced physical, sensory or mental capabilities, or lack of experience and knowledge, unless they have been given supervision or instruction concerning use of the appliance by a person responsible for their safety.
- Under no circumstances should you attempt to repair the machine yourself. Repairs carried out by inexperienced persons may cause injury or serious malfunctioning. Contact your local Service Centre. Always insist on genuine spare parts.

## 1.5 Installation

- This appliance is heavy. Care should be taken when moving it.
- When unpacking the appliance, check that it is not damaged. If in doubt, do not use it and contact the Service Centre.
- All packing and transit bolts must be removed before use. Serious damage can occur to the product and to property if this is not adhered to. See relevant section in the user manual.
- After having installed the appliance, check that it is not standing on the inlet and drain hose and the worktop is not pressing the electrical supply cable.
- If the appliance is installed on a carpeted floor, please adjust the feet in order to allow air to circulate freely.
- Always be sure, that there is no water leakage from hoses and their connections after the installation.
- Any plumbing work required to install this appliance should be carried out by a qualified plumber.
- Any electrical work required to install this appliance should be carried out by a qualified electrician.



**May cause electric shock!** if the machine is not connected to an earthed/ground system. DO NOT touch the wet clothes and metal parts.

## 1.6 Use

- This appliance is designed for domestic use. It must not be used for purposes other than those for which it was designed.
- Only wash fabrics which are designed to be machine washed. Follow the instructions on each garment label.
- Do not overload the appliance. See the relevant section in the user manual.
- Before washing, ensure that all pockets are empty and buttons and zips are fastened. Avoid washing frayed or torn articles and treat stains such as paint, ink, rust, and grass before washing.
- Garments which have been in contact with volatile petroleum products should not be machine washed. If volatile cleaning fluids are used, care should be taken to ensure that the fluid is removed from the garment before placing in the machine.
- Never pull the power supply cable to remove the plug from the socket; always take hold of the plug itself.
- Never use the washing machine if the power supply cable, the control panel, the working surface or the base are damaged so that the inside of the washing machine is accessible.

## 2. PRODUCT DESCRIPTION

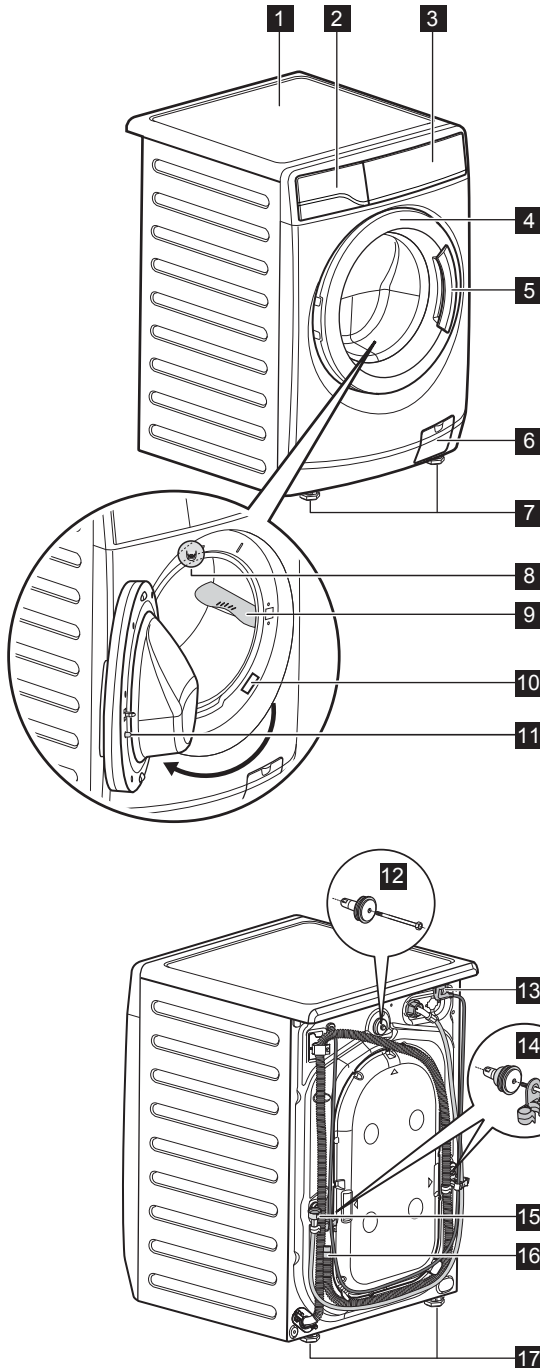

### 2.1 Parts

- 1** Worktop
- 2** Detergent/Softener Dispenser  
For more information see page 16.
- 3** Control Panel
- 4** Door
- 5** Door Handle
- 6** Drain Pump Filter

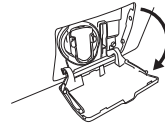

For more information see page 23.

- 7** Level Adjustment Feet (Front)
- 8** Drum Light
- 9** Drum Lifter
- 10** Rating Label
- 11** Child Safety Device

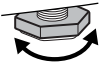

For more information see page 5.

- 12** Transit Bolt
- 13** Mains Cable
- 14** Transit Bolts + Hose Support
- 15** Water Inlet Hose
- 16** Water Drain Hose
- 17** Level Adjustment Feet (Back)

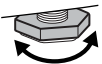

### **!** CAUTION !

All transit bolts (3 pcs) must be removed before using the appliance.

## 2.2 Product Feature

### • Load Sensor

This machine has “Load Sensing Device” which shows how much load you put in the machine and maximum load recommended for selected wash program.

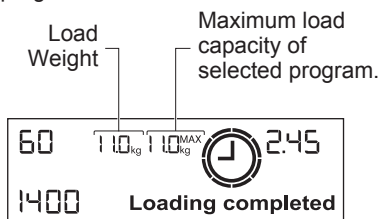



- The display will show “Loading completed” when max limit is reached for selected program.
- On the display, the weight of the laundry updates by 0.5 kg steps.
- The weight is a general indication that changes with the type of the laundry.
- If you exceed the max weight limit of a program, the max limit number will flash along with buzzer warning sound.



- i** The display shows these indicators when the door is open.
- i** The weight shown on display is an approximate weight only.
- i** For correct operation of the load sensor, activate the appliance and set a wash program **BEFORE** loading the laundry in the drum.

### • Detergent Quantity Indicator

The text bar also gives the indication about the detergent quantity, when the door is closed after the laundry load. By default, the detergent quantity indication is given as a percentage.

100% is the maximum detergent quantity (quantity as per the product manufacturers’ instructions) that you can put in the “” compartment of the detergent drawer.

You can set the indication as “ml” to have more precision, by pressing  and  at the same time for approximately 3 seconds.

- The message “Set dosage detergent” comes on in the text bar.
- Press “” repeatedly to set the detergent dosage to maximum manufacturer recommendation on the packaging which is the 100% equivalent.
- For the maximum detergent quantity, see the detergent manufacturer recommendation on packaging.
- i** You can set 100% equivalent 0 ml to 330 ml.
- Press  to confirm.



## 2.3 Accessories

- Plastic Caps



To close the holes on the rear side of the cabinet after the removal of the transit bolts.

- Plastic Hose Guide



To connect the drain hose on the edge of a sink.

---

### 3. CONTROL PANEL

#### 3.1 Control Panel Description

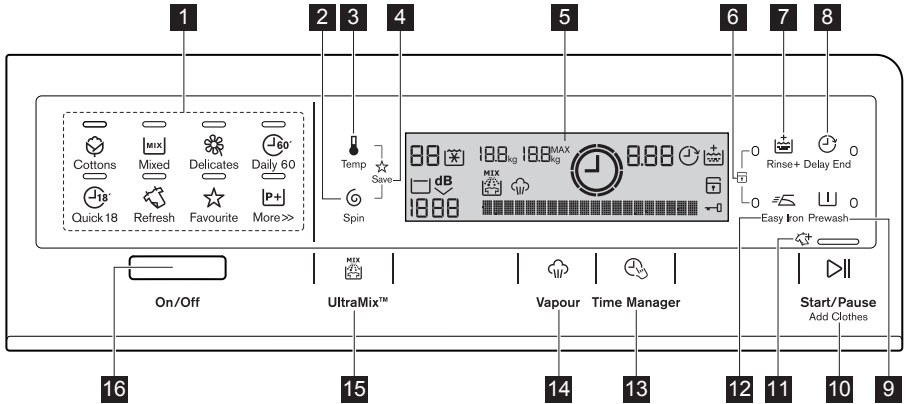





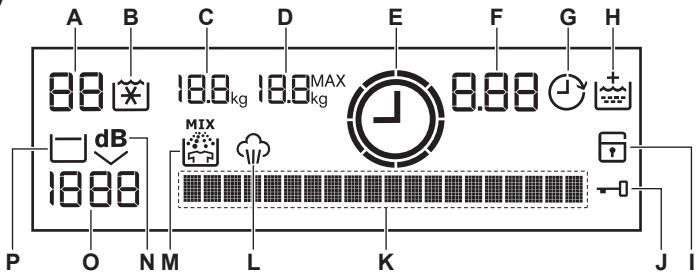









- |   |   |
|---|---|
| <b>1</b> Program Touchpads              | <b>9</b> Prewash Touchpad                   |
| <b>2</b> Spin Selection Touchpad        | <b>10</b> Start/Pause, Add Clothes Touchpad |
| <b>3</b> Temperature Selection Touchpad | <b>11</b> Add Clothes Function Symbol       |
| <b>4</b> Save Favourite Program         | <b>12</b> Easy Iron Touchpad                |
| <b>5</b> Display                        | <b>13</b> Time Manager Touchpad             |
| <b>6</b> Child Lock (see page 14)       | <b>14</b> Vapour Touchpad                   |
| <b>7</b> Rinse Plus Touchpad            | <b>15</b> UltraMix Touchpad                 |
| <b>8</b> Delay End Touchpad             | <b>16</b> On/Off Button                     |

#### 3.2 Display



- |   |                                |
|---|--------------------------------|
| <b>A)</b> Wash Temperature                          | <b>K)</b> Text Bar             |
| <b>B)</b> Cold Water Icon                           | <b>L)</b> Vapour Icon          |
| <b>C)</b> Load Weight                               | <b>M)</b> Ultramix System Icon |
| <b>D)</b> Maximum Load Capacity Of Selected Program | <b>N)</b> Extra Silent Icon    |
| <b>E)</b> Time Manager Icon                         | <b>O)</b> Spin Speed           |
| <b>F)</b> Washing Cycle Time/Delay End Time         | <b>P)</b> Rinse Hold Icon      |
| <b>G)</b> Delay End Icon                            |                                |
| <b>H)</b> Rinse Plus Icon                           |                                |
| <b>I)</b> Child Lock Icon                           |                                |
| <b>J)</b> Door Lock Icon                            |                                |
- i** "C" and "D" are only displayed when door is open.

### 3.3 Program Chart

Program ; Temperature range	Max. Load (Dry Clothes) ; Max. Spin Speed	Type of load and soil level
 <b>Cottons</b> ;  2) to 90 °C	11 kg ; 1400 rpm	White and coloured cotton. (Adjust wash time according to soil level. See Time Manager table on page 13)
 <b>Mixed</b> ;  to 60 °C	4 kg ; 1200 rpm	Synthetic or mixed fabric items. (Adjust wash time according to soil level. See Time Manager table on page 13)
 <b>Delicates</b> ;  to 40 °C	4 kg ; 1200 rpm	Delicate fabrics such as acrylics, viscose, polyester items. (Adjust wash time according to soil level. See Time Manager table on page 13)
 <b>Daily 60</b> ; 30 °C to 60 °C	5.5 kg ; 1400 rpm	Coloured cotton e.g. shirts, blouses, towels and undergarments with normal level of soil.
 <b>Quick 18</b> ; 30 °C	1.5 kg ; 800 rpm	Lightly soiled synthetics or mixed fabrics.
 <b>Refresh</b>	1.5 kg ; Clothes tumble in vapour.	This cycle removes odours and helps to dewrinkle the laundry.  Do not add detergent.
 <b>Favourite</b>	-	Recall you favourite program.
 <b>More &gt;&gt;</b> (Press this program touchpad repeatedly to find more program as list below)		
- Baby Care ;  to 40 °C	4 kg ; 1200 rpm	Baby cotton clothes and delicate knitting items with normal soil.
- Sports ; 30 °C	2.5 kg ; 800 rpm	A gentle program designed for mixed fabrics found in delicate clothes.
- Wool ;  to 40 °C	2 kg ; 1200 rpm	Specially tested program for woollen garments bearing the "Pure new woollen, non-shrink, machine washable" label.
- Energy Saver ; 40 °C and 60 °C <sup>1)</sup>	11 kg ; 1400 rpm	White and colourfast cotton. Set this program to have a good washing results and decrease the energy consumption. The time of the washing program is extended.
- Spin	11 kg ; 1400 rpm	To spin the laundry and drain the water in the drum.
- Rinse + Spin	11 kg ; 1400 rpm	To rinse and spin the laundry.
- Bedding ;  to 60 °C	3 kg ; 800 rpm	Special program for one synthetic blanket, duvet, bedspread and so on. (Adjust wash time according to soil level. See Time Manager table on page 13)
- Heavy Duty ; 40 °C to 90 °C	11 kg ; 1400 rpm	For a heavily soiled cotton wash load.
- Tub Clean ;	-	For cleaning the tub.

1) Energy Saver program with 60 °C option selected is recommended for a full load of normally soiled cottons.

2) Symbol "" represents Cold water.

### 3.4 Program Options Compatibility

Program Option	Spin									
	No Spin	Rinse Hold	Extra Silent							
Cottons	✓	✓	✓	✓	✓	✓	✓	✓	✓	✓
Mixed	✓	✓	✓	✓	✓	✓	✓	✓	✓	✓
Delicates	✓	✓	✓	✓	✓		✓	✓	✓	✓
Daily 60	✓	✓		✓	✓					✓
Quick 18	✓	✓			✓					X
Vapour Refresh					✓				✓	
Baby Care	✓	✓	✓	✓	✓		✓		✓	X
Sports	✓				✓					X
Wool	✓	✓	✓		✓					X
Energy Saver	✓	✓		✓	✓		✓	✓	✓	X
Spin	✓				✓					
Rinse + Spin	✓	✓			✓					
Bedding	✓				✓			✓	✓	✓
Heavy Duty	✓	✓	✓	✓	✓				✓	X
Tub Clean					✓					X

✓) Can select and disable option.

X) Cannot disable option

1) Vapour option can be combined with temperature 40 to 90 °C only.

### 3.5 Options

#### Temperature Touchpad ( )

Press this touchpad repeatedly to increase or decrease the wash temperature if you want your laundry to be washed at a temperature different from the one proposed by the washing machine.

#### Spin Selection Touchpad ( )

Press this touchpad repeatedly to increase or decrease the spin speed or select Rinse Hold, if you want your laundry to be spun at a speed different from the one proposed by the washing machine.

- **No Spin ( --- )**

No spin option eliminates all the spin phases and increase the number of rinses.

- **Extra Silent ( )**

By selecting this option, the machine will not drain the water of the last rinse to avoid wrinkling the laundry. All spinning phases are suppressed.

This washing cycle is very quiet, and can be selected at night or other appropriate times.

The door stays locked with the water in the drum. To continue the cycle, you must press **▷||** (Start/Pause).

- **Rinse Hold ( )**

By selecting this option the water of the last rinse is not emptied out and the drum turns regularly to prevent the laundry creases.

The door is still locked to indicate that the water must be emptied out.

The door stays locked with the water in the drum. To continue the cycle, you must press **▷||** (Start/Pause).

#### Rinse Plus Touchpad ( )

This option is recommended for people who are allergic to detergents, and in areas where the water is very soft. Press it to add two rinse phases to a program. The indicator of this option will be on.

### Delay End Touchpad ( )

Before you start the program, this option makes it possible to define the end of the washing program from minimum of 1 hour to maximum of 19 hours.

**i** If program duration is longer than 3 hours, minimum Delay End option starts from 4 hours.

Press the Delay End touchpad to choose the end time as you wish. The display shows the number of hours and the indicator beside the touchpad is on.

**i** **This option must be selected after choosing the wash program, and before pressing the “Start/Pause” touchpad.**

For example, if the program duration of your selected program is 3.20 hours and you define the “Delay End” time to 6 hours. This means your wash program will finish in 6 hours. (See diagram)

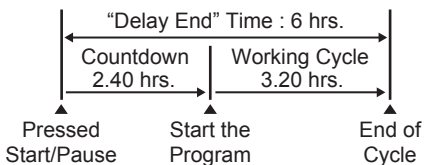

After selecting Delay End time, press Start/Pause touchpad to start the program. Machine will then countdown and update time on the display every hours until it reaches the starting point of the wash cycle.

If you wish to modify or cancel Delay End option after starting the program, follow the steps below:

- set the washing machine to PAUSE by pressing “Start/Pause” touchpad;
- deselect this option by pressing “Delay End” touchpad repeatedly till the display shows delay time “0”;
- press the “Start/Pause” to start the program.

### Easy Iron Touchpad ( )

When selecting this option, the laundry is gently washed and spun to avoid creasing. In this way, ironing is easier. The indicator of this option will be on.

### Prewash Touchpad ( )





Select this option if you wish your laundry to be pre-washed before the main wash. Use this option for heavy soil. The indicator of this option will be on.

When you set this function, put the detergent into the “  ” compartment.

This function increases the program duration.

### Time Manager ( )

This option allows you to adjust the wash time. Press this touchpad repeatedly to decrease or increase the wash time according to the soil level of your wash. Use the table below as a guide.

Soil Level	Light	Medium	Normal	Heavy
Wash Level				

### Vapour Touchpad ( )

Select this option to add approximately 30 minutes of tumbling in vapour during the wash cycle. Vapour helps open fabric fibers up to allow laundry additives to release tough stains. The indicator of this option will be on.

#### NOTE:

- Vapour may not necessarily be visible inside the drum during a vapour wash cycle. Vapour is created below the drum and allowed to naturally rise into the clothes.
- Vapour may not be present during the entire vapour wash cycle.
- Vapour function is more effective with half load.
- At the end of the Vapour cycle, the clothes will be warmer, softer and detached from the drum.

**i** If Vapour option is selected, rinse temperatures will be elevated.

During a vapour cycle, you may notice vapour exiting from the drain hose of the washing machine, this is normal and there is no cause for alarm.

### UltraMix ( )

When you select this option, the detergent is blended and dissolved in water within a “pre-mixing technology” chamber. This will activate the active ingredients of the detergent before circulating the water onto the clothes.

#### NOTE:

- This option is strongly recommended for Cold wash.
- As “UltraMix (  )” feature enhances the detergent activation. Please reduce the detergent dosage if you see foam covering the glass door completely.

## 3.6 Settings

### Save Favourite Program ( )

Program settings that are frequently used can be saved (e.g. Cotton, 60°C, 1200 rpm, with Prewash and Rinse Plus).

To program/re-program Favourite with your own selections and save them, proceed as follows:

1. Put machine in Stand-By mode.
2. Select your desired wash settings.
3. To save favourite program, press “Temp” and “Spin” touchpads at the same time until the display shows the wording “Program Saved”.

To recall the favourite wash program, press “Favourite (  )” program.

You will get acknowledgement on the screen when the Favourite program is loaded.



You can recall a favourite wash program ONLY when the washing machine is in the program selection mode. Otherwise touching Favourite will have no effect.

### Child Safety Lock Option ( )



Your appliance is provided with CHILD SAFETY LOCK which permits you to leave the appliance unsupervised with the door closed without having to worry that children might be injured by or cause damage to the appliance.

#### Set this option after pressing the Start/Pause touchpad.

### To set “Child Lock” option:

- To activate the function, press “Rinse + (  ) and Easy Iron (  )” touchpads at the same time until the display shows the symbol .

 The touchpads are locked (except for the On/Off button).



- To deactivate the function, press “Rinse + (  ) and Easy Iron (  )” touchpads at the same time until the symbol “  ” goes off.

 This function remains enabled even after the appliance is switched off.

### Enabling/Disabling End-Of-Wash Buzzer

This setting permits you to either enable or disable the buzzer at the end of the program. As an example, you might wish to disable this buzzer when you start a wash when going to bed, so that when the wash finished approximately 1 hour later, it will not disturb you through the night.

 Error warning beeps such as critical faults are not disabled.

To disable the buzzer sound, press “Easy Iron (  ) and Prewash (  )” touchpads at the same time for 3 seconds, and listen for “BEEP, BEEP”.

To return to default configuration press these 2 touchpads at the same time for 3 seconds, and listen for “BEEP”.

## 3.7 Start/Pause ( ) and Add Clothes ( ) Touchpad

This touchpad has 2 functions:

### • Start/Pause ( )

After you have selected the desired program and options, press this touchpad to start the machine. The Start/Pause pilot light will stop flashing and remain lit until the water level is above the bottom edge of the door then pilot light goes OFF. If you have selected a “Delay End” option, the countdown will begin and will be shown in the display.

To interrupt a program which is running, press this touchpad to pause the machine, the Start/Pause pilot light flashes.

To restart the program from the point at which it was interrupted, press this touchpad again, the Start/Pause pilot light will stop flashing.

- **Add Clothes** (  )

 You can only add clothes if “Start/Pause” pilot light is lit.

While running a program, you may add clothes by:

1. Pressing the “Start/Pause” touchpad to pause the program.
2. Wait for the machine to come to a complete stop before opening the door.
3. Add clothing and close the door.
4. Resume the program by pressing “Start/Pause” touchpad again.

## 4. BEFORE FIRST USE

 **During installation or before first use you may observe some water in the machine. This is a residual water left in the machine after a full functional test in the factory to ensure the machine is delivered to customers in perfect working order and is no cause for concern.**

1. Ensure that the electrical and water connections comply with the installation instructions.
2. Put 2 litres of water in the detergent compartment for washing phase. This activates the drain system.

3. Select a Cottons cycle at 90 °C, without any laundry in the machine, to remove any manufacturing residue from the drum and tub then start the machine.

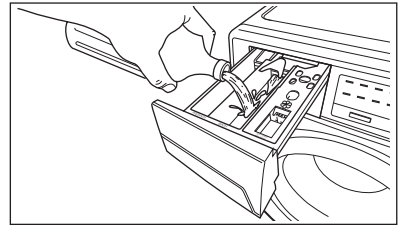

## 5. DAILY USE

### 5.1 Loading The Laundry

1. Turn the water tap on.
2. Connect the main plug to the main socket.
3. Press the On/Off button to turn on the washing machine. Touch one of the Program Icons to choose the wash program you require.

 **For correct operation of the load sensor, activate the appliance and set a wash program BEFORE loading the laundry in the drum. (see page 8)**

4. Check and remove objects (if there are any) that could be trapped in the fold.

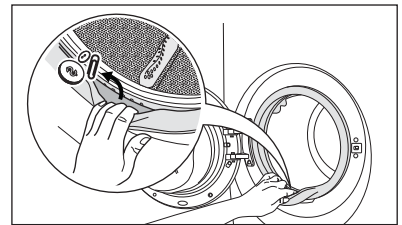

5. Place the laundry in the drum, one item at a time, shaking them out as much as possible. (Refer to page 19 “WASHING HINTS”)
6. Close the door.

 **CAUTION**

Make sure that no laundry remains between the seal and the door.

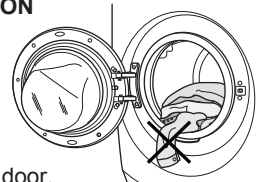

## 5.2 Using Detergent And Additives

**i** **IMPORTANT: Please read “Detergents Type and Quantity of Detergent” on page 20 before use.**

### 1. Detergent Dispenser Drawer

The detergent dispenser is divided into three compartments.

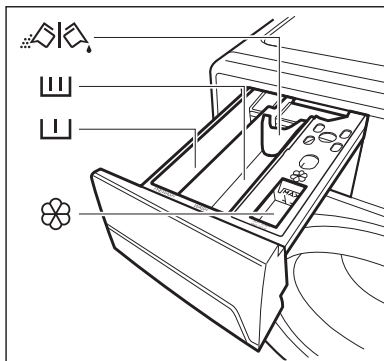

- **U** Compartment “MAIN WASH”  
This compartment is used for detergent on all programs.
- **L** Compartment “PREWASH”  
This compartment is only used for detergent when a Prewash is selected.
- **Flower** Compartment “SOFTENER”  
This compartment is used for fabric conditioner and starching agent.



Detergent flap

Flap for powder or liquid detergent.



- Position down : for liquid detergent.
- Position up : for powder detergent (factory setting).

**i** **When you use the liquid detergent:**

- Do not use gelatinous or thick liquid detergents.
- Do not put more liquid than the maximum level.
- Do not set the “Prewash” phase.
- Do not set the “Delay End”.

### 2. Measure out the detergent and the fabric softener;

- Pull out the dispenser drawer until it stops.
- Measure out the amount of detergent required, pour it into the main wash compartment.

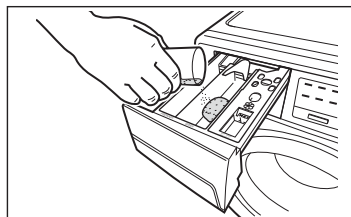

- If you wish to carry out the “Prewash” phase, pour it into the compartment marked **L**.
- If required, pour fabric softener into the compartment marked “**Flower**”.

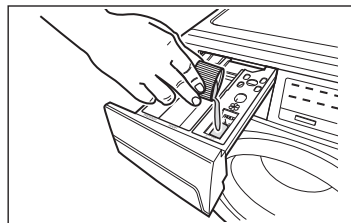

**i** The amount used must not exceed the “MAX” mark in the drawer.



If you use thick softeners it is recommended to dilute with water.

- Close the drawer gently.

**i** Residues of detergent, softener and water may remain in the dispenser. It is recommended to clean the dispenser regularly to remove any residue.





## 5.3 Options Setting

1. If you want your laundry to be spun or use temperature different from the one proposed by the washing machine, press the Spin “” and the temperature “” touchpads repeatedly to change the spin speed and temperature.

Press the option touchpads, if you want your laundry to be washed with special functions.

### NOTE

- Different functions can be combined which is dependent on the program selected.
  - If an option is not compatible with the wash program selected, the message “Not Available” will flash on display along with buzzer sound.
2. If you want to adjust washing time, press the “Time Manager ()” touchpad repeatedly to increase or decrease washing time. See Time Manager guide on page 13.  
If you want to define the end of the washing program, press the “Delay End ()” touchpad repeatedly to choose your washing machine working time.

## 5.4 Starting A Cycle (▷||)

To start a program, press the Start/Pause touchpad. The corresponding pilot light will stop flashing and a default program duration will be displayed on the screen.

### NOTE

- If you press any touchpad while a program is operating, the message “Not Available” will flash on display along with buzzer sound. (except Start/Pause touchpad and On/Off button)
-  After approx. 15 minutes from the start of a program:
- The appliance will automatically adjust the selected program duration according to the type and size of the load.
  - The display will show adjusted program duration.

## 5.5 Interruption Of A Program

- To pause, press Start/ Pause. The indicator will start flashing.
- Press the Start/Pause again. The program will continue.

## 5.6 Changing A Program

Changing a running program is possible only by switching off the appliance.

- Press the “On/Off” button to cancel the program and to turn off the appliance.
- Press the “On/Off” button again to start the appliance.

Now you can set a new wash program and change any available options. Press Start/Pause to start the new program.



-  The appliance will not drain the water (except programs; Refresh, Spin, Rinse + Spin, Tub Clean).

## 5.7 Changing The Options

It may be possible to change some of the options after a wash program has started.

1. Press the touchpad Start/Pause. The indicator will start flashing.
2. If available change the options that you wish.
3. Press Start/Pause again. The program will continue.

## 5.8 Opening The Door



While a program or the Delay End is operating, the appliance door is locked and the display shows the indicator “”. First, set the machine to PAUSE by pressing the “Start/Pause” touchpad. Wait until the door lock indicator “” goes off, then the door can be opened.

If the door lock indicator “” does not disappear, this means that the machine is already heating and the water level is above the bottom edge of the door or the drum is turning. In this case the door CAN NOT be opened. If you need to open it, you must drain the water to open the door.



**In case of emergency please refer to “Emergency door opening” on page 28.**

## 5.9 At The End Of The Program

- The appliance stops automatically.
- The acoustic signal will operate.
- The display will show “”.
- The indicator of the touchpad Start/Pause goes off.
- The door lock indicator “” goes off.
- Remove the laundry from the appliance. Make sure that the drum is empty.
- Keep the door partly open, to prevent the mildew and odours.
- Turn off the water tap.



At the end of the program, the time remaining can suddenly decrease from 7 minutes or less to 0 due to the overestimated total program time during the load sensing phase. In some cases (with perfectly balanced load) the program time can be shorter than the time estimated after the load sensing phase is completed. This is a normal behavior of the machine and not a cause for concern as it does not compromise its performance.

## 5.10 When The Washing Program Is Completed, But There Is Water In The Drum

(Option “Rinse Hold” or “Extra Silent” is used)

- The drum turns regularly to prevent the creases in the laundry.
- The indicator “Start/Pause” flashes to remind you to drain the water.
- The door lock indicator “” is on. The door stays locked.

You must drain the water to open the door.

### To drain the water:

1. Press the “Start/Pause ” touchpad. The appliance drains the water and spins with the maximum spin speed for selected program.

**Alternatively**, before pressing the “Start/Pause” touchpad, you can press the “Spin ” touchpad to change the spin speed. You can select “No Spin”, if you want the machine to only drain the water.

2. When the program is completed and the door lock indicator “” goes off, you can open the door.
3. Press the “On/Off” button to deactivate the appliance.



### NOTE:

After approximately 18 hours, if you do not press Start/Pause touchpad, the appliance will drain and spin automatically (except for “Wool” program) .

## 5.11 AUTO Off Mode

The AUTO Off mode automatically deactivates the appliance to decrease the energy consumption when:

- You do not press any buttons for 5 minutes before you press “Start/Pause”.



Press the “On/Off” button to activate the appliance again.

- After 5 minutes from the end of the washing program.
  - Press the “On/Off” button to reactivate the appliance. Display will show the end of the last wash.
  - Press any touchpad again to show the last wash program.
  - Touch the program touchpad to set a new wash program.

## 6. WASHING HINTS

### 6.1 Sorting The Laundry

Follow the wash code symbols on each garment label and the manufacturer's washing instructions. Sort the laundry as follows: whites, coloureds, synthetics, delicates, woollens.

### 6.2 Temperatures

90°C	For normally soiled white cottons and linen (e.g. tea cloths, towels, tablecloths, sheets...).
60°C 50°C	For normally soiled, colourfast garments (e.g. shirts, night dresses, pajamas...) in linen, cotton or synthetic fibres and for lightly soiled white cotton (e.g. underwear).
40°C 30°C Cold	For delicate items (e.g. net curtains), mixed laundry including synthetic fibres and woollens bearing the label pure new wool, machine washable, non-shrink.

### 6.3 Before Loading The Laundry

- Make sure that no metal objects are left in the laundry (e.g. hair clips, safety pins, pins).
- Button up pillowcases, close zip fasteners, hooks and poppers. Tie any belts or long tapes.
- Wash bras, pantyhose and other delicates in a mesh laundry bag, which you can purchase from your supermarket.

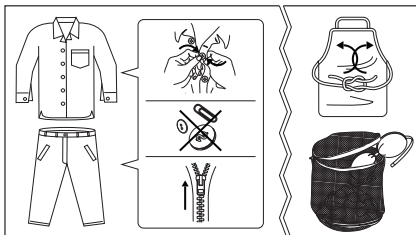

- Make sure that you wash lint collectors separately from lint producers.

- Never wash whites and coloureds together. Whites may lose their "whiteness" in the wash.
- New coloured items may run in the first wash; they should therefore be washed separately the first time.
- Remove persistent stains before washing.
- Rub particularly soiled areas with a special detergent or detergent paste. Treat curtains with special care. Remove hooks or tie them up in a bag or a net.

### 6.4 Maximum Loads

Recommended loads are indicated in the program charts. General rules:

Cotton, linen:	drum full but not too tightly packed;
Synthetics:	drum no more than half full;
Delicate fabrics and woollens:	drum no more than one third full.

Washing a maximum load makes the most efficient use of water and energy. For heavily soiled laundry, reduce the load size.

### 6.5 Removing Stains

Stubborn stains may not be removed by just water and detergent. It is therefore advisable to treat them prior to washing.

**Blood:** treat fresh stains with cold water. For dried stains, soak overnight in water with a special detergent then rub in the soap and water.

**Oil based paint:** moisten with benzine stain remover, lay the garment on a soft cloth and dab the stain; treat several times.

**Dried grease stains:** moisten with turpentine, lay the garment on a soft surface and dab the stain with the fingertips and a cotton cloth.

**Rust:** oxalic acid dissolved in hot water or a rust removing product used in cold water. Be careful with rust stains which are not recent since the cellulose structure will already have been damaged and the fabric tends to hole.

**Mould stains:** treat with bleach, rinse well (whites and fast coloureds only).

**Grass:** soap lightly and treat with bleach (whites and fast coloureds only).

**Ball point pen and glue:** moisten with acetone (\*), lay the garment on a soft cloth and dab the stain.

**Lipstick:** moisten with acetone (\*) as above, then treat stains with methylated spirits. Remove any residual marks from white fabrics with bleach.

**Red wine:** soak in water and detergent, rinse and treat with acetic or citric acid, then rinse. Treat any residual marks with bleach.

**Ink:** depending on the type of ink, moisten the fabric first with acetone (\*), then with acetic acid; treat any residual marks on white fabrics with bleach and then rinse thoroughly.

**Tar stains:** first treat with stain remover, methylated spirits or benzine, then rub with detergent paste.

(\*) do not use acetone on artificial silk.

## 6.6 Detergents Type And Quantity Of Detergent

Low sudsing detergent is required for this washing machine to prevent oversudsing problems, unsatisfied washing result and harm to the machine. Low sudsing detergents designed for front load washing machines are labelled "Front Loading", "high efficiency", "HE", such as Cold Power for Front Loaders or "Matic".

**Do not use wrong types of detergent, such as Top Loading, Handwash detergent or Soap-Based products in your frontload washing machine. This can result in excessive suds, longer cycle time, low spin speeds, poor rinsing and overloading of the motor.**

### Quantity of detergent to be used

The choice of detergent and use of correct quantities not only affects your wash performance, but also helps to avoid waste and protect the environment. Although biodegradable, detergents contain substances which in large quantities can upset the delicate balance of nature.

The choice and quantity of detergent will depend on ;

- type of fabric (delicates, woollens, cottons, etc.) ;
- the colour of clothes ;
- size of the load ;
- degree of soil ;
- wash temperature ; and
- hardness of the water used.

Water hardness is classified by so-called "degrees" of hardness.

Information on hardness of the water in your area can be obtained from the relevant water supply company, or from your local authority.

You may have to try using the detergent quantity as per manufacturers' instructions then compare the wash result to the list below and adjust the amount of detergent for your future washes accordingly.

### Not enough washing powder causes:

- the washload to turn grey,
- greasy clothes.

### Too much washing powder causes:

































- sudsing,
- reduced washing effect,
- inadequate rinsing.

### Use less detergent if:

- you are washing a small load,
- the laundry is lightly soiled,
- large amounts of foam during washing.

## 7. INTERNATIONAL WASH CODE SYMBOLS

 These symbols appear on fabric labels, in order to help you choose the best way to treat your laundry.

 <b>Energetic wash</b>	 Max. wash temperature 95 °C	 Max. wash temperature 60 °C	 Max. wash temperature 40 °C	 Max. wash temperature 30 °C	 Hand wash	 DO NOT wash at all
 <b>Delicate wash</b>			 			
 <b>Bleaching</b>	 Bleach in cold water			 DO NOT bleach		
 <b>Ironing</b>	 Hot iron max. 200 °C	 Warm iron max. 150 °C	 Lukewarm iron max. 110 °C	 DO NOT iron		
 <b>Dry cleaning</b>	 Dry cleaning in all solvents	 Dry cleaning in perchlorethylene, petrol, pure alcohol, R 111 & R 113	 Dry cleaning in petrol, pure alcohol and R 113	 DO NOT dry clean		
 <b>Drying</b>	 Flat	 On the line	 On clothes hanger	 High temperature  Low temperature Tumble dry	 DO NOT tumble dry	

## 8. CARE AND CLEANING

 **WARNING!** You must DISCONNECT the appliance from the electricity supply, before you can carry out any cleaning or maintenance work.

### 8.1 External Cleaning

Clean the appliance only with soap and warm water. Fully dry all the surfaces.

 **CAUTION! Do not use alcohol, solvents or chemical products.**

### 8.2 Descaling

The water we use normally contains lime. It is a good idea to periodically use a water softening powder in the machine.

Do this separately from any laundry washing, and according to the softening powder manufacturer's instructions.

This will help to prevent the formation of lime deposits.

### 8.3 After Each Wash

Leave the door open for a while. This helps to prevent mould and stagnant smells forming inside the appliance.

Keeping the door open after a wash will also help to preserve the door seal.

### 8.4 Maintenance Wash With “Tub Clean” Program

With the use of low temperature washes it is possible to get a build up of residues inside the drum.

We recommend to use “Tub Clean” program to clean the drum regularly to remove any residue.

**To run a maintenance wash:**

- The drum should be empty of laundry.
- Select the “Tub Clean” program.
- Use a normal measure of detergent, must be a powder with biological properties.
- Press Start/Pause to start the program.

### 8.5 Cleaning The Dispenser Drawer

The washing powder and additive dispenser drawer should be cleaned regularly. Remove the drawer by pressing the catch downwards and by pulling it out. Flush it out under a tap, to remove any traces of accumulated powder.

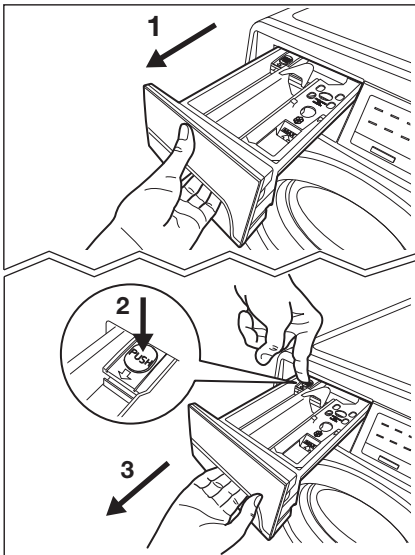

To aid cleaning, the top part of the additive compartment should be removed.

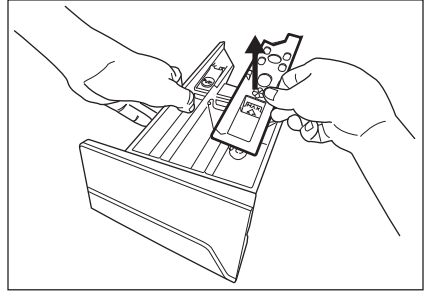

### 8.6 Cleaning The Drawer Recess

Having removed the drawer, use a small brush to clean the recess, ensuring that all washing powder residue is removed from the upper and lower part of the recess. Replace the drawer and run the rinse program without any clothes in the drum.

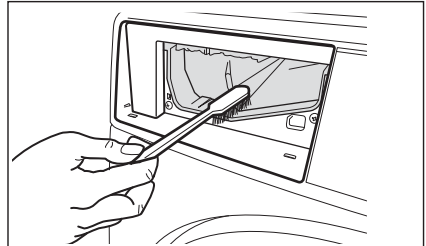

### 8.7 Cleaning The Pump

**i** Regularly examine the drain pump and make sure that it is clean.

Clean the pump if:

- The appliance does not drain the water.
- The drum cannot turn.
- The appliance makes an unusual noise because of the blockage of the drain pump.
- The display shows an alarm code because of the problem with water drain.

**! WARNING!**

1. Disconnect the mains plug from the mains socket.

- Do not remove the filter while the appliance is operating. Do not clean the drain pump if the water in the appliance is hot. The water must be cold before you clean the drain pump.

### To clean the drain pump:

- Open the drain pump door.

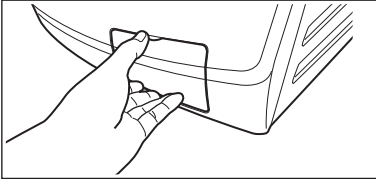

- Pull the flap down, then squeeze the legs on both sides of the cover together and pull out (as picture).

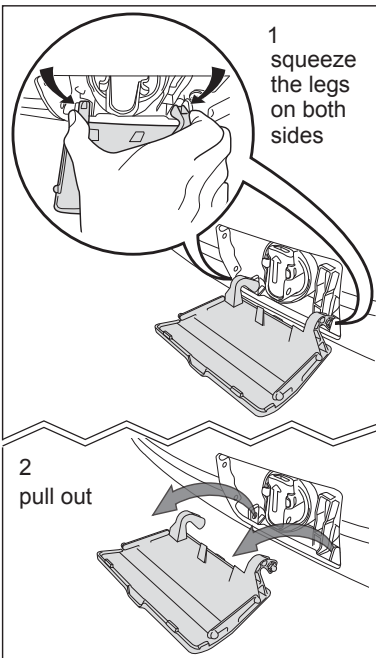
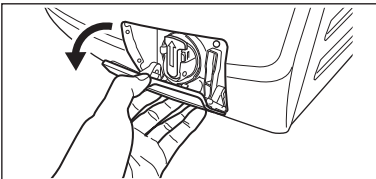

- Place a suitable water container below the recess of the drain pump to collect the water that flows out.

Press the two levers and pull forward the drainage duct to let the water flow out.

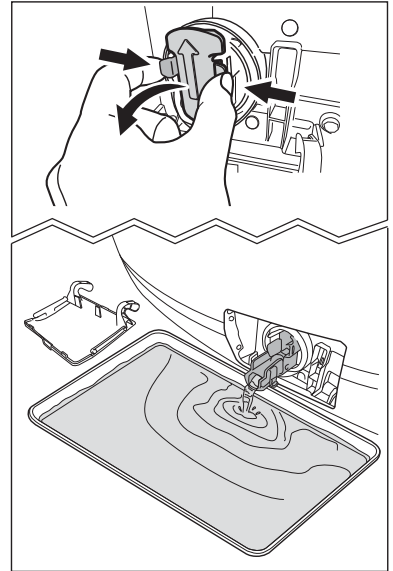

- When the container is full of water, put the drainage duct back again and empty the container. Do step 3 again and again until no more water flows out from the drain pump.

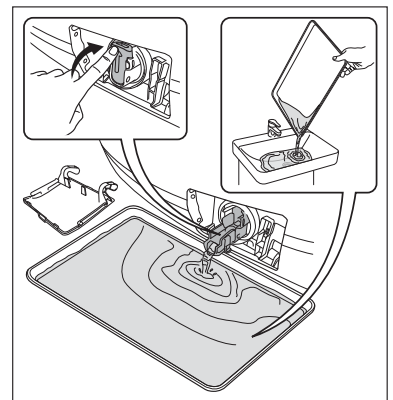

5. Pull back the drainage duct and turn the filter counter-clockwise to remove it.

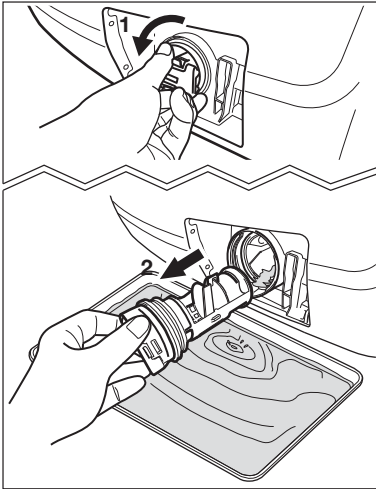

6. Remove fluff and objects from the pump (if there are any).

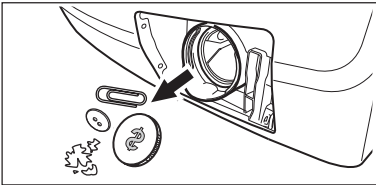

7. Make sure that the impeller of the pump can turn. If this does not occur, contact the service centre.

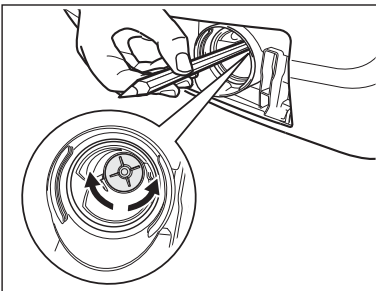

8. Clean the filter under the water tap.

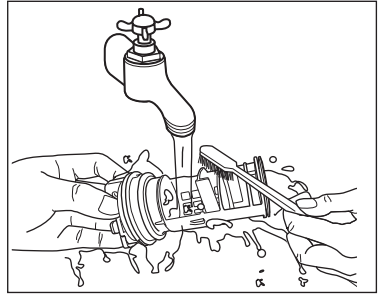

9. Put the filter back in the pump into the special guides. Make sure that you correctly tighten the filter to prevent leakages.

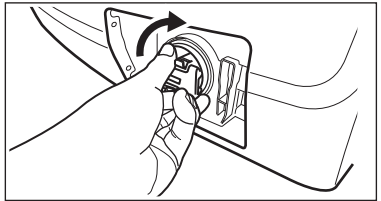

10. Put the flap back and close the drain pump door.

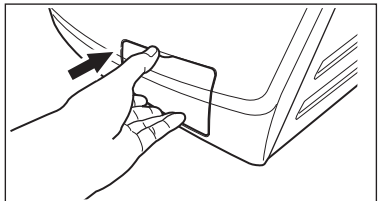

## 8.8 Cleaning The Water Inlet Filter

If your water is very hard or contains traces of lime deposit, the water inlet filter may become clogged. It is therefore a good idea to clean it from time to time.

### To clean the water inlet filters:

1. Close the water tap.
2. Remove the water inlet hose from the water tap.
3. Clean the filter in the inlet hose with a stiff brush.



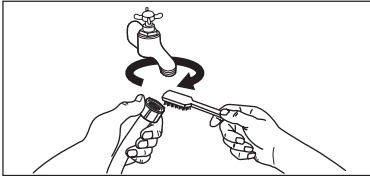

4. Remove the inlet hose behind the appliance.
5. Clean the filter in the valve with a stiff brush or a towel.

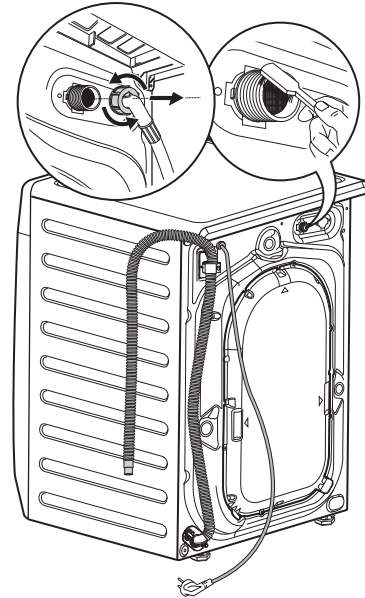

6. Install the inlet hose again. Make sure that the couplings are tight to prevent leakages.

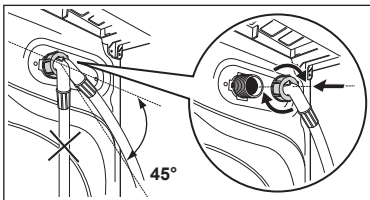

7. Open the water tap.

## 8.9 Frost Precautions

If the appliance is installed in an area where the temperature can be less than 0 °C, remove the remaining water from the inlet hose and the drain pump.

### Emergency Drain

1. Disconnect the main plug from the main socket. Turn off the water tap.
2. Remove the water inlet hose.
3. Remove the drain hose from the rear support and unhook it from sink or spigot.

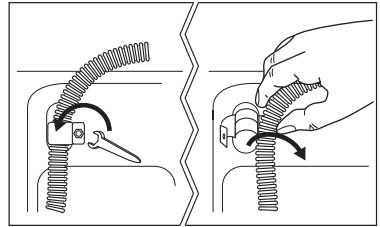

4. Put the end of the drain and inlet hose in a container. Let the water flow out of the hoses.

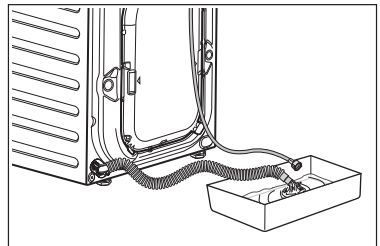

5. When no more water flows, install the inlet hose and the drain hose again.

### ! NOTE

Make sure that the temperature is more than 0 °C before you use the appliance again.

## 9. TROUBLESHOOTING

### 9.1 Possible Failures

Certain problems are due to lack of simple maintenance or oversights, which can be solved easily without calling out an engineer. Before contacting your local Service Centre, please carry out the checks listed below.

Once the problem has been eliminated, press the Start/Pause button to restart the program. If after all checks, the problem persists, contact your local Service Centre.



**WARNING!** Deactivate the appliance before you do the checks.

### Alarm Code:

<b>E10</b>	The appliance does not fill with water properly.
<b>E20</b>	The appliance does not drain the water.
<b>E40</b>	The appliance door is open or not closed correctly. Please check the door!
<b>E40</b>	The main supply is unstable. Wait until the main supply is stable.
<b>E91</b>	No communication between electronic elements of the appliance. Switch off and switch on again.

Malfunction	Possible cause => Solution
<b>The washing machine does not start:</b>	• The door has not been closed. (Error code: E40) => Close the door firmly.
	• The plug is not properly inserted in the power socket. => Insert the plug into the power socket.
	• There is no power at the socket. => Please check your domestic electrical installation.
	• The Start/Pause touchpad has not been pressed. => Press the Start/Pause touchpad.
	• The "Delay End" has been selected. => If the laundry are to be washed immediately, cancel the "Delay End".
	• The Main supply is unstable. (If E40 appears in the display.) => Wait until the main supply is stable. Appliance will start automatically.
<b>The machine does not fill the water:</b>	• The water tap is closed. (Error code: E10) => Open the water tap.
	• The inlet hose is squashed or kinked. (Error code: E10) => Check the inlet hose connection.
	• The filter in the inlet hose is blocked. (Error code: E10) => Clean the water inlet hose filter.
	• The door is not properly closed. (Error code: E40) => Close the door firmly.
<b>The machine fills then empties immediately:</b>	• The end of the drain hose is too low. (Error code: E10) => Refer to relevant paragraph in "water drainage" section.

Malfunction	Possible cause => Solution
<b>The machine does not empty and/or does not spin:</b>	<ul style="list-style-type: none"> <li>• The drain hose is squashed or kinked. (Error code: E20) =&gt; Check the drain hose connection.</li> <li>• The drain pump is clogged. (Error code: E20) =&gt; Clean the drain filter.</li> <li>• The option “Extra Silent” or “Rinse Hold” has been selected. =&gt; Press Start/Pause touchpad to drain the water or select spin program.</li> <li>• The laundry is not evenly distributed in the drum. =&gt; Pause the machine and redistribute laundry manually.</li> </ul>
<b>There is water on the floor:</b>	<ul style="list-style-type: none"> <li>• Too much detergent or unsuitable detergent (creates too much foam) has been used. =&gt; Reduce detergent quantity and use correct type of detergent (refer page 20).</li> <li>• Check whether there are any leaks from one of the inlet hose fittings. It is not always easy to see this as the water runs down the hose; check to see if it is damp. =&gt; Check the water inlet hose connection.</li> <li>• The drain hose is damaged. =&gt; Call Service.</li> </ul>
<b>Unsatisfactory washing results:</b>	<ul style="list-style-type: none"> <li>• Too little detergent or unsuitable detergent has been used. =&gt; Increase detergent quantity or use different detergent (refer page 20).</li> <li>• Stubborn stains have not been treated prior to washing. =&gt; Use commercial products to treat the stubborn stains.</li> <li>• The correct temperature was not selected. =&gt; Check if you have selected the correct temperature.</li> <li>• Excessive laundry load. =&gt; Reduce load.</li> </ul>
<b>The door will not open:</b>	<ul style="list-style-type: none"> <li>• The program is still running. =&gt; Wait until the end of cycle.</li> <li>• There is water in the drum. =&gt; You must drain the water to open the door (refer “Opening The Door” on page 17).</li> <li>• This problem may be caused by a failure of the appliance. =&gt; Contact Service. If you need to open the door, please read carefully “Emergency door opening” on next page.</li> </ul>
<b>The machine vibrates or is noisy:</b>	<ul style="list-style-type: none"> <li>• The transit bolts and packing have not been removed. =&gt; Check the correct installation of the appliance.</li> <li>• The support feet have not been adjusted. =&gt; Check the correct levelling of the appliance.</li> <li>• The laundry is not evenly distributed in the drum. =&gt; Pause the machine and redistribute laundry manually.</li> <li>• There is very little laundry in the drum. =&gt; Load more laundry.</li> <li>• Unstable floors eg. wooden floors. =&gt; Refer to relevant paragraph in “Positioning” section.</li> </ul>
<b>Cycle time longer than displayed:</b>	<ul style="list-style-type: none"> <li>• Detergent over dose. =&gt; Reduce the detergent quantity or use another one. (Refer page 20 “Detergents Type And Quantity Of Detergent”).</li> <li>• Machine unbalance. =&gt; Redistribute laundry manually in the drum and start the spin phase again.</li> </ul>

Malfunction	Possible cause => Solution
<b>The cycle is shorter than the time displayed.</b>	<ul style="list-style-type: none"> <li>The appliance calculated a new time according to the laundry load.</li> </ul>
<b>Spinning starts late or the machine does not spin:</b>	<ul style="list-style-type: none"> <li>The electronic unbalance detection device has cut in because the laundry is not evenly distributed in the drum. The laundry is redistributed by reverse rotation of the drum. This may happen several times before the unbalance disappears and normal spinning can resume. If, after 10 minutes, the laundry is still not evenly distributed in the drum, the machine will not spin. In this case, redistribute the load manually and select the spin program. =&gt; Pause the machine and redistribute laundry manually.</li> </ul>
<b>The machine makes an unusual noise:</b>	<ul style="list-style-type: none"> <li>Machine not installed properly. =&gt; Make sure the levelling of the appliance is correct. Refer to "Installation".</li> </ul>
	<ul style="list-style-type: none"> <li>Transit bolts or packaging not removed. =&gt; Make sure that the packaging and/or the transit bolts are removed. Refer to "Unpacking".</li> </ul>
	<ul style="list-style-type: none"> <li>The load may be too small. =&gt; Add more laundry in the drum.</li> </ul>
<b>No water is visible in the drum:</b>	<ul style="list-style-type: none"> <li>Machines based on modern technology operate very economically using very little water without affecting performance.</li> </ul>

## 9.2 Emergency Door Opening

In case of power failure or appliance failure, the appliance door remains locked. The wash program continues when power is restored. If the door remains locked in case of failure, it is possible to open it using the emergency unlock feature.

**Before opening the door:**



**WARNING!**

**Make sure that the water temperature and the laundry are not hot. Wait until they cool down if necessary.**



**WARNING!**

**Make sure that the drum is not rotating. Wait until the drum stops rotating if necessary.**



**WARNING!**

**Make sure that the water level inside the drum is not too high. If necessary, perform an Emergency Drain (see page 25).**

To open the door proceed as follows:

1. Press the On/Off button to switch the appliance off.
2. Disconnect the mains plug from the mains socket.
3. Open the filter flap.
4. While pulling the emergency unlock strap (red strap) downward, pull the door handle to open the door.

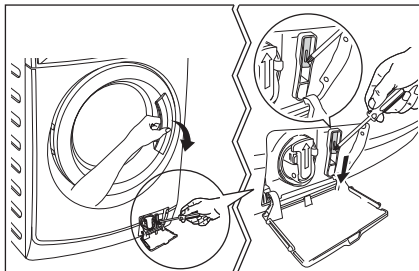

5. Take out the laundry.
6. Close the filter flap.



If you are unable to identify or solve the problem, contact our service centre.

Before calling service centre, make a note of the model, serial number and purchase date of your machine: the Service Centre will require this information.

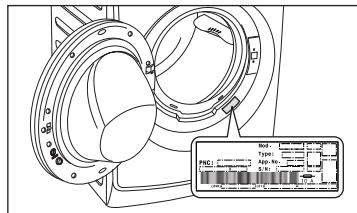

## 10. TECHNICAL DATA

Dimensions (Height / Width / Depth)	85 X 60 X 66.9 cm	
Power supply (Voltage / Frequency)	220-240 V / 50 Hz	
Total power absorbed	2100 W	
Minimum fuse protection	10 A	
Water supply pressure (Maximum / Minimum)	0.8 MPa / 0.05 MPa	
Maximum dry clothes capacity	Cottons	11 Kg
	Mixed	4 Kg
	Delicates	4 Kg
	Daily 60	5.5 Kg
	Quick 18	1.5 Kg
	Refresh	1.5 Kg
	Baby Care	4 Kg
	Sports	2.5 Kg
	Wool	2 Kg
	Energy Saver	11 Kg
	Spin	11 Kg
Rinse + Spin	11 Kg	
Bedding	3 Kg	
Heavy Duty	11 Kg	
Spin speed (Maximum / Minimum)	1400 rpm / 400 rpm	

# 11. INSTALLATION

## 11.1 Unpacking



### CAUTION!

All transit bolts and packing must be removed before using the appliance.

You are advised to keep all transit devices so that they can be refitted if the machine ever has to be transported again.

1. Use gloves. Cut and remove four cut out straps as shown.

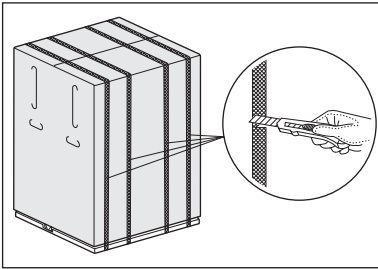

2. Remove the carton box. Remove the polystyrene packaging materials. Remove the plastic bag which cover the machine.

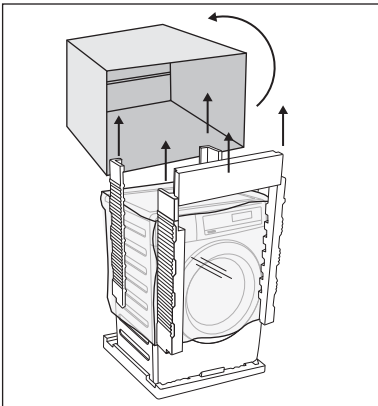

3. Open the door. Remove the polystyrene piece from the door seal and all the items from the drum.

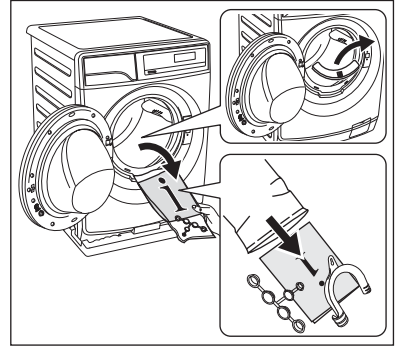

4. Put one of the polystyrene packaging elements on the floor behind the appliance. Carefully put down the appliance with the rear side on it. Make sure not to damage the hoses.

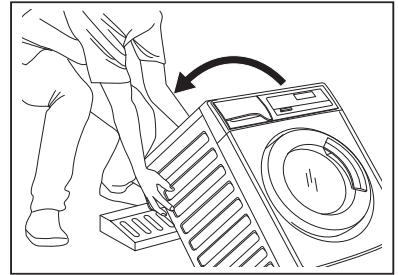

5. Remove the polystyrene base.

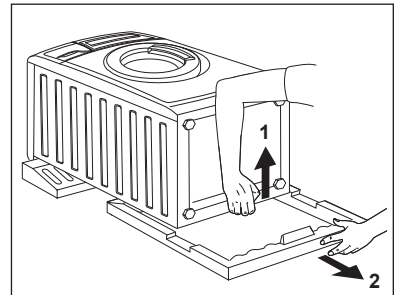

6. Pull up the appliance in vertical position.
7. Remove the power supply cable and the drain and inlet hoses from the hose holders (A) on the rear of the appliance.

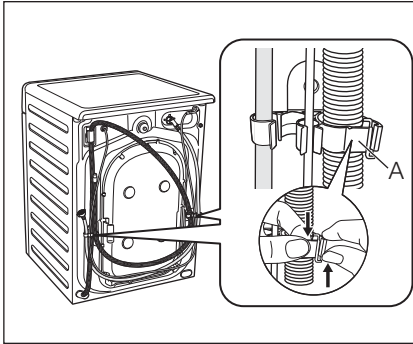

8. Remove the three transit bolts.
9. Pull out the plastic spacers.

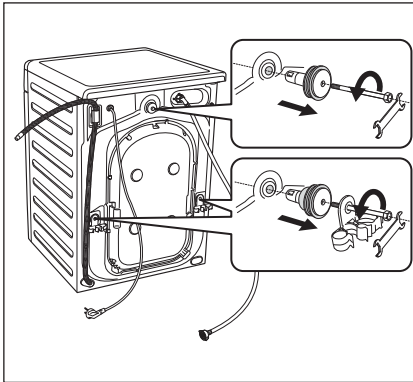

10. Put the plastic caps in the holes.  
You can find these caps in the user manual bag.

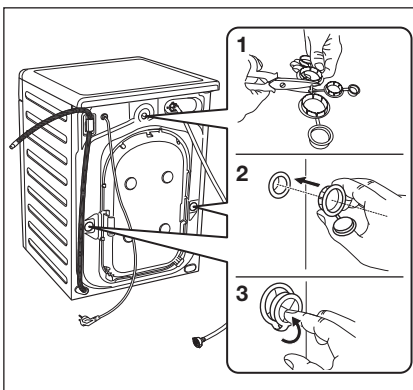

## 11.2 Positioning

It is important that your washing machine stands firm and leveled on the floor to ensure correct operation. The appliance must not be installed behind a lockable door, a sliding door or a door with a hinge on the opposite side to avoid restricting the washing machine door.

Use a spirit level on the top and side of the washing machine to check the levels.

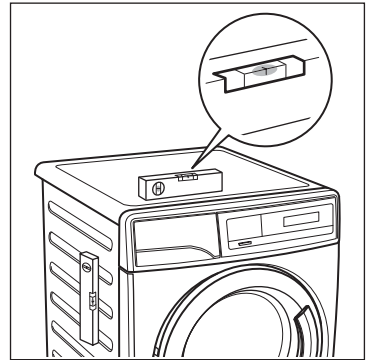

If you do not have a spirit level, as a guide use the edge of a door frame, cupboard or bench to check that the washing machine is leveled.

Loosen or tighten the feet to adjust the level. A correct adjustment of the appliance level prevents vibration, noise and the movement of the appliance when in operation.

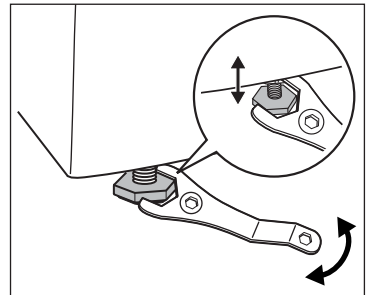

When the washing machine is levelled, try to rock it from corner to corner. If it does rock, adjust the legs again until it is levelled and does not rock.

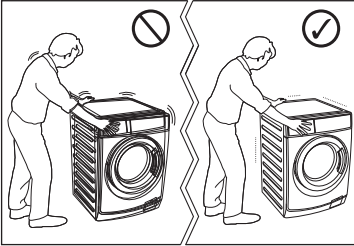

Never place cardboard, wood or similar materials under the machine to compensate for any unevenness in the floor. Install the machine on a flat hard floor. Make sure that air circulation around the machine is not impeded by carpets, rugs etc.

Check that the machine does not touch the wall or cupboard units.

### 11.3 Water Inlet

Connect the water inlet hose to a tap with 3/4" BSP thread.

Use the hose supplied with the washing machine. **DO NOT USE OLD HOSES.**

The other end of the inlet hose which connects to the machine can be turned in any direction.

Simply loosen the fitting, rotate the hose and retighten the fitting, making sure there are no water leaks.

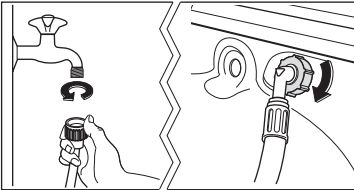

The inlet hose must not be lengthened. If it is too short and you do not wish to move the tap, you will have to purchase a new, longer hose specially designed for this type of use.

### 11.4 Water Drainage

The end of the drain hose can be positioned in three ways:

- Hooked over the edge of a sink using the plastic hose guide supplied with the machine.

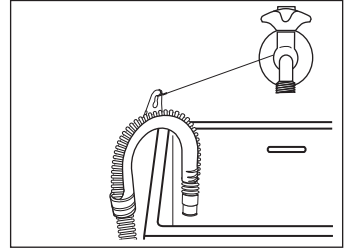

In this case, make sure the end cannot come unhooked when the machine will be emptied.

This could be done by tying it to the tap with a piece of string or attaching it to the wall.

- In a sink drain pipe branch. This branch must be above the trap so that the bend is at least 60 cm above the ground.

- Directly into a drain pipe at a height of not less than 60 cm and not more than 90 cm.

The end of the drain hose must always be ventilated, i.e. the inside diameter of the drain pipe must be larger than the outside diameter of the drain hose.

The drain hose must not be twisted or curled. Run it along the floor; only the part near the drainage point must be raised.

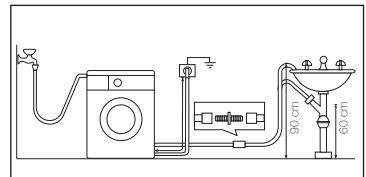

For the correct functioning of the machine, the drain hose must remain hooked on the proper support piece situated on the top part of back side of the appliance.



## 11.5 Electrical Connection

This machine is designed to operate on a 220-240 V, single-phase, 50 Hz supply.

**“An incorrect power supply may void your warranty.”**

Check that your domestic electrical installation can take the maximum load required (2.1 kW), also taking into account any other appliances in use.



### CAUTION!

**Connect the machine to an earthed socket outlet.**

The manufacturer declines any responsibility for damage or injury through failure to comply with the above safety precaution.

Should the appliance power supply cable need to be replaced, this shall be carried out by our Service Centre.

When the appliance is installed, the power supply cable must be easily accessible.

If this appliance is supplied from a cord extension set or electrical portable outlet device, the cord extension set or electrical portable device must be positioned so that it is not subject to splashing or ingress of moisture.

## 12. ENVIRONMENT CONCERNS

### 12.1 Packaging Materials



The materials marked with the symbol  are recyclable.

>PE<=polyethylene  
>PS<=polystyrene  
>PP<=polypropylene

This means that they can be recycled by disposing them properly in appropriate collection containers.

### 12.2 Old Machine

Use authorized disposal sites for your old appliance. Help to keep your country tidy!

The symbol  on the product or on its packaging indicates that this product may not be treated as household waste.

Instead it shall be handed over to the applicable collection point for the recycling of electrical and electronic equipment.

By ensuring this product is disposed of correctly, you will help prevent potential negative consequences for the environment and human health, which could otherwise be caused by inappropriate waste handling of this product.

For more detailed information about recycling of this product, please contact your local city office, your household waste disposal service or the shop where you purchased the product.

### 12.3 Ecological Hints

To save water, energy and to help protect the environment, we recommend that you follow these tips:

- Normally soiled laundry may be washed without prewashing in order to save detergent, water and time (the environment is protected too!).
- The machine works more economically if it is fully loaded.
- With adequate pre-treatment, stains and limited soiling can be removed; the laundry can then be washed at a lower temperature.
- Measure out detergent according to the water hardness, the degree of soiling and the quantity of laundry being washed.

## KAMI MEMIKIRKAN TENTANG DIRI ANDA

Terima kasih kerana membeli perkakas Electrolux. Anda telah memilih produk yang membawa bersamanya pengalaman profesional dan inovasi yang telah sudah berkembang sejak berdekad-dekad lamanya. Pintar dan bergaya, ia telah direka bentuk dengan memikirkan tentang diri anda. Maka, setiap kali anda menggunakannya, anda boleh berasa yakin mengetahui bahawa anda akan memperoleh hasil yang hebat.

Selamat datang ke Electrolux.

**layari laman web kami untuk:**



Dapatkan nasihat penggunaan, risalah, penyelesaian masalah, maklumat servis:  
**www.electrolux.com**

## PENJAGAAN DAN PERKHIDMATAN PELANGGAN

Kami mengesyorkan penggunaan bahagian ganti tulen. Semasa menghubungi Servis, pastikan bahawa anda telah menyediakan data yang berikut. Maklumatnya boleh didapati pada plat label. Model, PNC, Nombor Siri.

 Amaran / Maklumat Awak-Keselamatan.

 Maklumat dan petua umum.

 Maklumat alam sekitar.

**Tertakluk pada perubahan tanpa notis.**

## KANDUNGAN

<b>1. MAKLUMAT KESELAMATAN</b>	
1.1 Syarat-Syarat Penggunaan .....	36
1.2 Keselamatan Kanak-Kanak .....	36
1.3 Peranti Keselamatan Kanak-Kanak .....	37
1.4 Keselamatan Am .....	37
1.5 Pemasangan .....	38
1.6 Penggunaan .....	38
<b>2. HURAIAN PRODUK</b>	
2.1 Bahagian .....	39
2.2 Ciri Produk .....	40
2.3 Aksesori .....	41
<b>3. PANEL KAWALAN</b>	
3.1 Penerangan Panel Kawalan .....	42
3.2 Skrin Paparan .....	42
3.3 Carta Program .....	43
3.4 Pilihan Program Keserasian .....	44
3.5 Opsyen .....	44
3.6 Tetapan .....	46
3.7 Pad sentuh Mula/Jeda (▶  ) dan Tambah Pakaian (↺) .....	47
<b>4. SEBELUM PENGGUNAAN YANG PERTAMA</b> .....	47

# KANDUNGAN

<b>5. PENGGUNAAN HARIAN</b>	
5.1 Memuat Cucian .....	48
5.2 Mengguna Detergen dan Perapi Tambahan .....	48
5.3 Tetapan Pilihan .....	49
5.4 Memula Program .....	49
5.5 Gangguan Program .....	50
5.6 Menukar Program .....	50
5.7 Menukar Opsyen .....	50
5.8 Membuka Pintu .....	50
5.9 Di Penghujung Program .....	50
5.10 Apabila Program Membasuh Selesai, Tetapi Terdapat Air Di Dalam Dram .....	50
5.11 AUTO Off Mod .....	51
<b>6. PETUA MEMBASUH</b>	
6.1 Mengasing Pakaian .....	51
6.2 Suhu .....	51
6.3 Sebelum Memuat Pakaian .....	51
6.4 Muatan Maksimum .....	52
6.5 Menanggal Kotoran .....	52
6.6 Jenis dan Kuantiti Bahan Pencuci .....	53
<b>7. SIMBOL KOD BASUH ANTARABANGSA</b> .....	54
<b>8. PENJAGAAN DAN PEMBERSIHAN</b>	
8.1 Pembersihan Luar .....	54
8.2 Menanggalkan Kesan Kapur .....	54
8.3 Selepas Setiap Cucian .....	54
8.4 Basuhan Penyelenggaraan Dengan Program “Tub Clean” .....	55
8.5 Membersih Petak Dispenser .....	55
8.6 Membersih Ceruk Petak .....	55
8.7 Membersih Pam .....	55
8.8 Membersih Penapis Aliran Air Masuk .....	57
8.9 Langkah Berwaspada Fros .....	58
<b>9. PENYELESAIAN MASALAH</b>	
9.1 Kegagalan Kemungkinan .....	59
9.2 Membuka Pintu Mesin Semasa Kecemasan .....	61
<b>10. DATA TEKNIKAL</b> .....	62
<b>11. PEMASANGAN</b>	
11.1 Mengeluarkan .....	63
11.2 Kedudukan Mesin .....	64
11.3 Saliran Air Masuk .....	65
11.4 Penyaliran Air .....	65
11.5 Sambungan Elektrik .....	66
<b>12. KEPRIHATINAN ALAM SEKITAR</b>	
12.1 Bahan Pembungkusan .....	67
12.2 Mesin Lama .....	67
12.3 Petua Ekologi .....	67

# 1. MAKLUMAT KESELAMATAN

## 1.1 Syarat-Syarat Penggunaan

Perkakas ini dimaksudkan untuk digunakan dalam rumah tangga dan aplikasi yang serupa seperti:

- Rumah ladang
- Pelanggan Pangsapuri Servis, pangsapuri percutian dan persekitaran penginapan.

Demi kepentingan keselamatan anda dan untuk memastikan penggunaan yang betul, sila baca panduan pengguna ini dengan berhati-hati sebelum memasang dan mengguna mesin ini, termasuk petua dan amaran. Untuk mengelakkan kesilapan dan kemalangan, sila memastikan bahawa semua orang yang menggunakan mesin ini memahami cara pengendalian dan ciri-ciri keselamatannya.

Simpan arahan ini dan pastikan ia tetap berada bersama mesin ini jikalau dipindahkan atau dijual, supaya semua orang yang menggunakan mesin ini akan mendapat maklumat yang betul mengenai penggunaan dan keselamatan alat ini.

## 1.2 Keselamatan Kanak-Kanak

- Mesin basuh ini bukan bertujuan untuk digunakan oleh kanak-kanak kecil atau orang yang uzur tanpa penyeliaan.
- Kanak-kanak hendaklah diselia untuk memastikan mereka tidak main dengan perkakas tersebut.
- Komponen pembungkusan (cth. lapik plastik, polistirena) boleh membahayakan kanak-kanak - awas sesak nafas! Jauhkan daripada capaian kanak-kanak.

- Simpan semua detergen di tempat yang selamat dan jauh daripada capaian kanak-kanak.
- Pastikan kanak-kanak atau haiwan peliharaan tidak memanjat masuk ke dalam dram.
- Mesin basuh ini disediakan dengan fungsi keselamatan kanak-kanak (  ) untuk menghindari kanak-kanak daripada tertukar program basuh dengan tidak sengaja. (Lihat halaman 46)

### 1.3 Peranti Keselamatan Kanak-Kanak

Apabila anda mengaktifkan peranti ini, pintu tidak dapat ditutupkan. Ini mencegah kanak-kanak atau haiwan peliharaan daripada terkunci di dalam.

- Untuk mengaktifkan peranti ini, pusingkan butang (TANPA menekannya) terdapat pada pintu mengikut arah jam sehingga alurnya melintang. Jika perlu, gunakan duit syiling.
- Untuk membatalkan peranti ini dan untuk menutup pintu, putar butang secara arah lawan jam sehingga alurnya menegak.

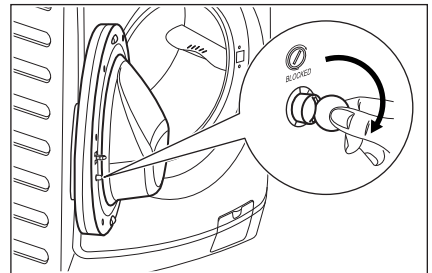

### 1.4 Keselamatan Am

- Adalah merbahaya untuk mengubah spesifikasi atau cuba mengubah suai produk ini dalam apa-apa cara sekali pun.
- Semasa program basuh bersuhu tinggi, kaca pintu boleh menjadi panas. Jangan sentuh !
- Pastikan haiwan peliharaan tidak memanjat masuk ke dalam dram. Untuk mengelakkan perkara ini, sila periksa dalam dram sebelum menggunakan perkakas.
- Objek seperti duit syiling, pin, paku, skru, batu atau apa-apa benda keras dan tajam boleh menyebabkan kerosakan yang serius dan tidak boleh dimasukkan ke dalam mesin.
- Basuh barang kecil seperti sarung kaki, les, tali pinggang boleh basuh di dalam beg basuh atau sarung bantal kerana barang seperti ini boleh termasuk ke dalam ruang antara tab dan dram dalaman.

- Hanya gunakan kuantiti pelembut pakaian dan detergen yang disarankan. Kerosakan kepada fabrik atau peralatan boleh berlaku jika anda terlebih muatkan. Rujuk cadangan kuantiti daripada pengilang.
- Jangan gunakan mesin pembasuh untuk membasuh barang dengan tetulang, barang tanpa jahit tepi atau terkoyak.
- Sentiasa cabut keluar plag perkakas dan matikan bekalan air selepas digunakan, dibersihkan dan diselenggarakan.
- Alat ini tidak ditulukan untuk penggunaan orang (termasuk kanak-kanak) yang kurang upaya fizikal, sensitiviti deria atau mental, atau kurang pengalamandan pengetahuan, melainkan mereka telah diberi penyeliaan atau arahan mengenai penggunaan alat ini oleh orang yang bertanggungjawab ke atas keselamatan mereka.
- Anda dilarang untuk memperbaiki mesin ini sendiri, walau dalam apa keadaan sekali pun. Kerja-kerja pembaikan yang dijalankan oleh orang yang tidak berpengalaman mungkin menyebabkan kecederaan atau malfungsi yang serius. Hubungi Pusat Servis setempat anda.

## 1.5 Pemasangan

- Perkakas ini berat. Hendaklah berjaga-jaga semasa memindahkannya.
- Semasa perkakas dikeluarkan daripada bungkusannya, periksa untuk pastikan tiada kerosakan. Jika berasa ragu, jangan gunakannya dan hubungilah Pusat Servis.
- Semua bolt pengangkutan dan bahan pembungkusan mesti dikeluarkan sebelum penggunaan. Kerosakan serius boleh berlaku kepada produk dan kepada harta jika tidak mematuhi langkah ini. Lihat bahagian yang relevan dalam manual pengguna ini.
- Setelah memasang perkakas ini, periksa bahawa ia tidak berdiri di atas hos saluran masuk dan saluran keluar, dan permukaan kerja tidak menekan kabel bekalan elektrik pada dinding.

- Jika mesin terletak di atas lantai berkarpet, sila laraskan kaki untuk membenarkan udara beredar dengan bebas.
- Sentiasa pastikan, bahawa tiada kebocoran air daripada hos dan sambungannya selepas pemasangan.
- Sebarang kerja paip untuk memasang perkakas ini harus dilakukan oleh tukang paip berkelayakan.
- Sebarang kerja elektrik untuk memasang perkakas ini harus dilakukan oleh tukang elektrik berkelayakan.



### **Boleh menyebabkan kejutan**

**elektrik!** Jika mesin tidak disambungkan pada alur keluar soket yang dibumikan. Jangan sentuh pakaian yang basah.

## 1.6 Penggunaan

- Bentuk mesin ini direka untuk kegunaan rumah. Jangan gunakannya untuk tujuan selain daripada yang dimaksudkan.
- Basuh fabrik yang ditujukan untuk dibasuh dengan mesin sahaja. Arahan di label pakaian hendaklah dipatuhi.
- Jangan memuatkan perkakas secara berlebihan. Lihat bahagian yang relevan dalam manual pengguna ini.
- Sebelum membasuh, pastikan semua poket dikosongkan dan butang serta zip diketatkan. Elakkan daripada membasuh pakaian berbulu atau koyak dan cuci kotoran seperti cat, dakwat, karat dan kesan rumput sebelum pembasuhan. Coli berwayar bawah TIDAK boleh dibasuh dengan mesin.
- Pakaian yang telah tercemar dengan produk petrol mudah meruap tidak boleh dibasuh dengan mesin. Jika cecair pembersihan mudah meruap digunakan, berhati-hati untuk memastikan bahawa cecair tersebut ditanggalkan daripada pakaian sebelum memasukkannya ke dalam mesin.

- Jangan tarik kabel bekalan kuasa untuk mencabut palam daripada soket; sentiasa pegang, palam dan cabut.
- Jangan gunakan mesin basuh jika kabel bekalan kuasa, panel kawalan, permukaan kerja atau tapak mesin rosak supaya bahagian dalam mesin basuh tersebut boleh diakses.

## 2. HURAIAN PRODUK

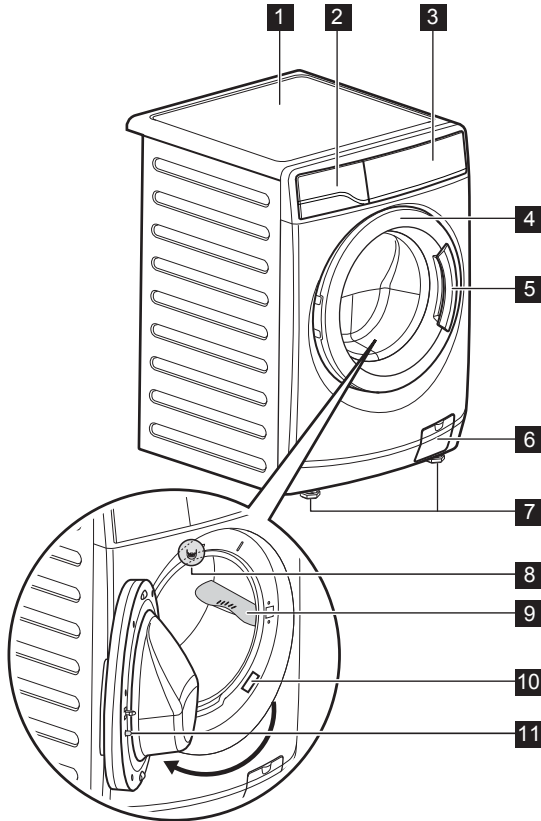

- 12 Bolt Pangangkutan
- 13 Kabel Wayar Utama
- 14 Bolt Pangangkutan + Pemegang Hos
- 15 Hos Saliran Air Masuk
- 16 Saliran Air keluar
- 17 Pelaras Kaki (Belakang)

**! AWAS!**

Semua bolt (3 pcs) pengangkutan mesti dikeluarkan sebelum menggunakan perkakas.

### 2.1 Parts

- 1 Permukaan atas mesin
- 2 Tempat Letak Detergen/Pelembut Fabrik (Lihat halaman 48)

- 3 Panel Kawalan
- 4 Pintu
- 5 Pemegang Pintu
- 6 Penapis Pam Alir

Lihat halaman 56

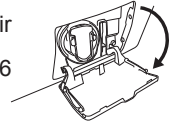

- 7 Pelaras Kaki (Hadapan)

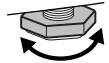

- 8 Lampu Dram
- 9 Pengangkat Bentuk Dedaun
- 10 Plat Label
- 11 Peranti Penyekat Pintu

Lihat halaman 37

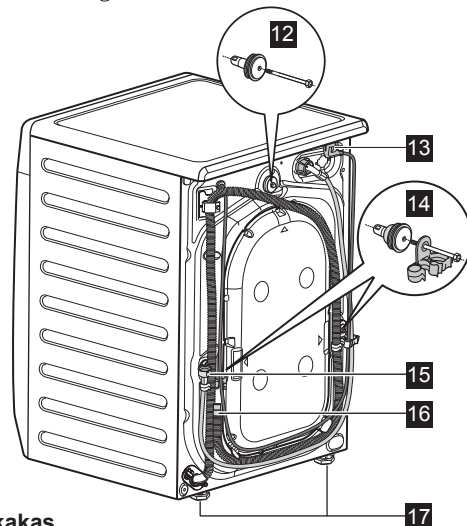

## 2.2 Ciri Produk

### • Load Sensor (Sensor Berat)

Mesin ini memiliki "Load Sensing Device" yang menunjukkan berapa banyak muatan yang anda letak di dalam mesin dan muatan maksimum yang disarankan untuk program cucian yang dipilih.

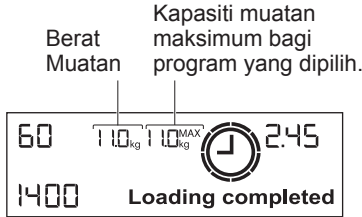

- Paparan akan menunjukkan "Loading completed (Muatan Selesai)" apabila had maksimum dicapai untuk program yang dipilih.
- Pada paparan, berat cucian dikemas kini sebanyak 0.5 kg setiap langkah.
- Berat adalah penunjuk umum yang berubah dengan jenis cucian.
- Jika beban anda melebihi had maksimum bagi program yang dipilih, nombor digit had maksimum akan berkelip dan berbunyi "Bip, Bip".

**i** Paparan menunjukkan penunjuk ini apabila pintu dibuka.



**i** Berat yang dipaparkan pada paparan ialah berat anggaran sahaja.

**i** Untuk operasi penderia berat yang lebih tepat, aktifkan perkakas dan tetapkan program cucian **SEBELUM** memuat cucian di dalam dram.

### • Tetapan Kuantiti Detergen

Bar teks juga memberi petunjuk mengenai kuantiti detergen, apabila pintu ditutup selepas pakaian dimasukkan.

Penunjuk kuantiti detergen diberikan sebagai peratusan. 100% ialah kuantiti maksimum (kuantiti bahan pencuci mengikut setiap arahan pengeluar produk) detergen yang boleh anda letakkan di dalam  ruang petak detergen.

Anda boleh menukarkan penunjuk sebagai *ml* untuk lebih tepat, dengan menekan  dan  pada masa yang sama untuk 3 saat.

- Mesej "Set dosage detergent" (Tetapkan dos bahan cuci) ada pada bar teks.
- Tekan "" berulang kali untuk menetapkan dos bahan cuci kepada cadangan maksimum pengilang pada bungkusan yang sama dengan 100%.
- Untuk kuantiti bahan cuci maksimum lihat cadangan pengilang bahan cuci pada bungkusan.

**i** Anda boleh mengeset setara 100% 0 ml hingga 330 ml.

- Tekan  untuk mengesahkan.



## 2.3 Aksesori

- Penutup plastik



Untuk menutup lubang pada bahagian sisi kabinet selepas pemuangan bolt pengangkutan.

- Panduan hos plastik

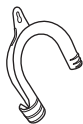

Untuk menyambung hos aliran kepada pinggir sinki.

---

### 3. PANEL KAWALAN

#### 3.1 Penerangan Panel Kawalan

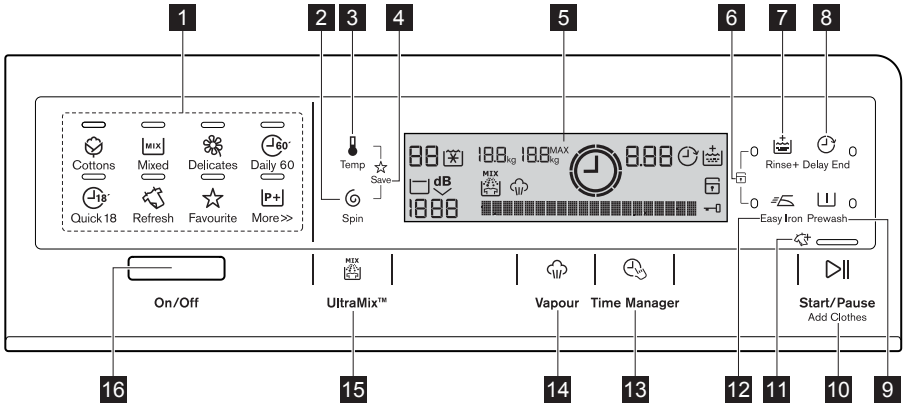

- |   |   |
|---|---|
| <ul style="list-style-type: none"> <li><b>1</b> Pad Sentuh Program</li> <li><b>2</b> Pad Sentuh Pilihan Kelajuan Putaran</li> <li><b>3</b> Pad Sentuh Laras Suhu</li> <li><b>4</b> Menyimpan Program Kegemaran</li> <li><b>5</b> Paparan</li> <li><b>6</b> Pilihan Keselamatan Kanak-Kanak (Lihat halaman 46)</li> <li><b>7</b> Pad Sentuh Bilas Tambahan</li> <li><b>8</b> Pad Sentuh Tunda Akhir</li> </ul> | <ul style="list-style-type: none"> <li><b>9</b> Pad Sentuh Prabusuh</li> <li><b>10</b> Pad sentuh Mula/Jeda ( <b>  </b> ) dan Tambah Pakaian (  )</li> <li><b>11</b> Simbol Fungsi Tambah Pakaian (  )</li> <li><b>12</b> Pad Sentuh Mudah Seterika</li> <li><b>13</b> Pad Sentuh Pengurus Masa</li> <li><b>14</b> Pad Sentuh Wap</li> <li><b>15</b> Pad Sentuh "UltraMix"</li> <li><b>16</b> Butang On/Off (Hidup/Mati)</li> </ul> |
|---|---|

#### 3.2 Skrin Paparan

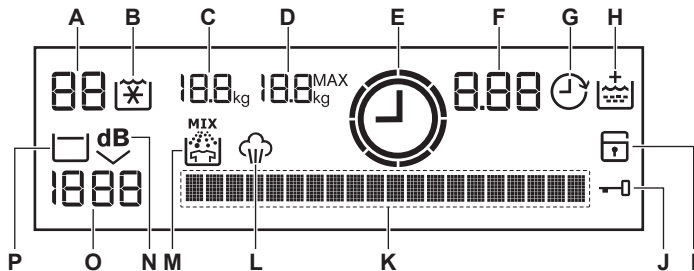

- |  |  |
|--|--|
| <ul style="list-style-type: none"> <li><b>A)</b> Suhu pembasuhan</li> <li><b>B)</b> Ikon Suhu Bilik</li> <li><b>C)</b> Berat muatan</li> <li><b>D)</b> Kapasiti muatan maksimum program yang dipilih</li> <li><b>E)</b> Ikon pengurus masa</li> <li><b>F)</b> Kitaran masa yang cuci/Tunda Tamat</li> <li><b>G)</b> Ikon Tunda Tamat</li> <li><b>H)</b> Ikon Bilas Tambahan</li> <li><b>I)</b> Ikon keselamatan kanak-kanak</li> </ul> | <ul style="list-style-type: none"> <li><b>J)</b> Ikon pintu dikunci</li> <li><b>K)</b> Bar teks</li> <li><b>L)</b> Ikon Wap</li> <li><b>M)</b> Ikon "Ultramix System"</li> <li><b>N)</b> Ikon ekstra senyap (Extra Silent)</li> <li><b>O)</b> Kelajuan putaran</li> <li><b>P)</b> Ikon Tunda bilasan (Rinse Hold)</li> </ul> <p><b>i</b> Paparan menunjukkan "C" dan "D" apabila pintu dibuka.</p> |
|--|--|

### 3.3 Carta Program

Program; Suhu	Muatan Maks. (Pakaian kering); Max. Kelajuan Putaran	Jenis muatan dan tahap kotoran
 <b>Cottons</b> (Kapas);  <sup>2)</sup> ke 90 °C	11 kg ; 1400 rpm	Kapas putih dan berwarna. (Laraskan masa mencuci mengikut tahap kotoran. Lihat jadual di halaman 45)
 <b>Mixed</b> (Campur);  ke 60 °C	4 kg ; 1200 rpm	Sintetik atau campuran item fabrik. (Laraskan masa mencuci mengikut tahap kotoran. Lihat jadual di halaman 45)
 <b>Delicates</b> (Kain lembut);  ke 40 °C	4 kg ; 1200 rpm	Fabrik lembut seperti akrilik, viscose, item poliester. (Laraskan masa mencuci mengikut tahap kotoran. Lihat jadual di halaman 45)
 <b>Daily 60</b> (Harian 60); 30 °C ke 60 °C	5.5 kg ; 1400 rpm	Kain kapas berwarna, cthnya. kemeja, blaus, tuala dan pakaian dalam dengan tahap kotoran yang biasa.
 <b>Quick 18</b> (Cepat); 30 °C	1.5 kg ; 800 rpm	Item fabrik sintetik dan campuran. Kotoran sedikit dan item untuk disegarkan semula.
 <b>Refresh</b> (Segarkan)	1.5 kg ; Baju dipusingkan dalam wap.	Kitaran ini membuang bau dan membantu untuk menyahkedut kain basuhan.  Kitaran ini tidak perlu menambah bahan pencuci.
 <b>Favourite</b> (Kegemaran) -	-	Memanggil semula program kegemaran anda.
 <b>More</b> (Lagi) >>	(Tekan program touchpad ini berulang kali untuk mencari lebih banyak program seperti senarai di bawah)	
- Baby Care (Bayi);  ke 40 °C	4 kg ; 1200 rpm	Baju kapas bayi dan item knit yang lembut dengan kekotoran normal.
- Sports (Sukan); 30 °C	2.5 kg ; 800 rpm	Program lembut yang direka bentuk untuk fabrik campuran pada pakaian yang lembut.
- Wool (Kain wol);  ke 40 °C	2 kg ; 1200 rpm	Program istimewa yang diuji untuk cucian pakaian wol yang berlabel "Wol baru tulen, tidak mengecut, label basuhan mesin" label.
- Energy Saver (Menjimatkan Tenaga); 40°C ke 60°C <sup>1)</sup>	11 kg ; 1400 rpm	Putih dan mudah luntur warna, kapas dengan kotoran normal. Tetapkan program ini untuk mempunyai hasil cucian yang baik dan kurangkan penggunaan tenaga. Masa bagi program pembasuhan dilanjutkan.
- Spin (Putar)	11 kg ; 1400 rpm	Untuk memusingkan basuhan dan mengosongkan air dalam dram.
- Rinse + Spin (Bilas) + (Putar)	11 kg ; 1400 rpm	Untuk membilas dan memusingkan basuhan.
- Bedding (Cadar Katil);  ke 60 °C	3 kg ; 800 rpm	Program kaws untuk satu selimut sintetik, duvet, cadar katil dan lain-lain. (Laraskan masa mencuci mengikut tahap kotoran. Lihat jadual di halaman 45)
- Heavy Duty (Tugas Berat); 40 °C ke 90 °C	11 kg ; 1400 rpm	Untuk muatan basuhan kain kapas yang sangat kotor.
- Tub Clean (Pembersihan Tab)	- kg ; - rpm	Untuk membersihkan dram basuhan.

1) Program Penjimat Tenaga dengan opsyen 60 °C dicadangkan untuk muatan penuh kapas dengan kotoran basa.

2) Simbol " " dibentangkan kepada Suhu Bilik.

### 3.4 Pilihan Program Keceriasan

Program Opsyen	Spin									MIX
	No Spin	Rinse Hold	Extra Silent							
Cottons	✓	✓	✓	✓	✓	✓	✓	✓	✓	✓
Mixed	✓	✓	✓	✓	✓	✓	✓	✓	✓	✓
Delicates	✓	✓	✓	✓	✓		✓	✓	✓	✓
Daily 60	✓	✓		✓	✓					✓
Quick 18	✓	✓			✓					X
Vapour Refresh					✓				✓	
Baby Care	✓	✓	✓	✓	✓		✓		✓	X
Sports	✓				✓					X
Wool	✓	✓	✓		✓					X
Energy Saver	✓	✓		✓	✓		✓	✓	✓	X
Spin	✓				✓					
Rinse + Spin	✓	✓			✓					
Bedding	✓				✓			✓	✓	✓
Heavy Duty	✓	✓	✓	✓	✓				✓	X
Tub Clean					✓					X

1) Opsyen wap boleh digabungkan dengan suhu pilihan 40 hingga 90 °C sahaja.

✓ Boleh memilih dan menyahdayakan pilihan.

X Tidak boleh menyahdayakan pilihan

### 3.5 Opsyen

#### Pad Sentuh Laras Suhu ( )

Jika ingin pakaian dicuci pada suhu yang lain daripada yang diusulkan oleh mesin, tekan butang ini berulang kali untuk meningkatkan atau mengurangkan suhu.

#### Pad Sentuh Pilihan Kelajuan

##### Putaran ( )

Tekan pad sentuh ini berulang kali untuk meningkatkan atau mengurangkan kelajuan putaran, jika anda ingin pakaian dicuci pada suhu yang lain daripada yang diusulkan oleh mesin pembasuh.

##### • No Spin (Tiada Putaran) ( --- )

Tiada opsyen putar yang menyingkirkan semua fasa putaran dan menambah bilangan bilasan.

##### • Extra Silent (Ekstra Senyap) ( )

Dengan memilih opsyen ini, mesin tidak akan mengeluarkan air daripada bilasan akhir untuk mengelakkan kain cucian daripada berkedut. Semua fasa putaran diberhentikan.

Kitaran pembasuhan ini sangat senyap, dan boleh dipilih pada waktu malam atau pada waktu lain yang sesuai.

Pintu tetap berkunci dengan air di dalam dram. Untuk meneruskan pusingan anda mesti menekan (Start/Pause).

##### • Rinse Hold (Tunda Bilasan) ( )

Dengan memilih opsyen ini, air bilasan terakhir tidak dikosongkan dan dram berputar dengan kerap untuk mengelakkan kain basuhan daripada berkedut. Pintu masih dikunci untuk menunjukkan bahawa semua air perlu dikeluarkan.

Pintu tetap berkunci dengan air di dalam dram. Untuk meneruskan pusingan anda mesti menekan (Start/ Pause).

##### Pad Sentuh Bilas Tambahan ( )

Pergunaan pilihan ini disyorkan untuk orang yang alah kepada bahan sisa cucian dan di kawasan yang airnya amat lembut. Pilih opsyen ini untuk menambah dua bilasan pada program. Penunjuk opsyen ini akan menyala.

### **Pad Sentuh Tunda Akhir** ( )

Sebelum anda memulakan program, opsyen ini membolehkan anda menentukan masa tamat program basuhan daripada minimum 1 jam hingga maksimum 19 jam.

**i** Jika tempoh program lebih lama daripada 3 jam, opsyen Tunda Akhir (Delay End) minimum bermula daripada 4 jam.

Tekan pad sentuh Tunda Akhir (Delay End) untuk memilih masa tamat seperti yang anda ingini. Paparan menunjukkan bilangan jam dan penunjuk di atas pad sentuh menyala.

**i** **Opsyen ini mesti dipilih selepas memilih program basuhan dan sebelum menekan pad sentuh “Start/Pause”.**

Sebagai contoh, jika tempoh program bagi program yang anda pilih ialah 3.20 jam dan anda menetapkan masa “Tunda Akhir” (Delay End) kepada 6 jam. Ini bermakna program basuhan anda akan tamat dalam masa 6 jam. (Lihat diagram di bawah)

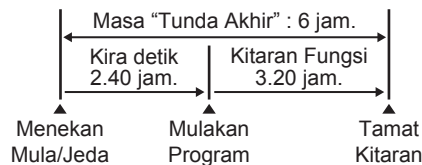

Selepas memilih masa Tunda Akhir (Delay End), tekan pad sentuh Mula/Jeda (Start/Pause) untuk memulakan program. Kemudian mesin akan mengira detik dan mengemaskinikan masa pada paparan setiap jam sehingga ia mencapai titik permulaan kitaran basuhan.

Sekiranya anda mengubah atau membatalkan opsyen Tunda Akhir selepas memulakan program, ikuti langkah-langkah di bawah:

- tetapkan mesin basuh kepada JEDA dengan menekan pad sentuh;
- nyahpilih pilihan ini dengan menekan pad sentuh “Tunda Tamat” berulang kali sehingga paparan menunjukkan masa tunda “  ”;
- tekan “Start/Pause” untuk memulakan program.

### **Pad Sentuh Mudah Seterika** ( )

Apabila butang ini dipilih cucian akan dibasuh dan diputar dengan perlahan untuk mengurangkan daripada kerenyukan. Cara ini memudahkan anda untuk menyeterikanya. Penunjuk opsyen ini akan menyala.

### **Pad Sentuh Prabasuh** ( )





Pilih opsyen ini jika anda inginkan kain cucian anda diprabasuh sebelum basuhan utama. Gunakan pilihan ini untuk kotoran yang degil. Penunjuk opsyen ini akan menyala.

Apabila anda menetapkan fungsi ini, masukkan detergen dalam ruang “  ”.

Fungsi ini meningkatkan tempoh program.

### **Pengurus Masa** ( )

Pilihan ini membolehkan anda melaraskan masa basuh. Tekan pad sentuh ini berulang kali untuk mengurangkan atau meningkatkan masa basuh mengikut tahap kotoran basuh anda. Gunakan jadual di bawah sebagai panduan.

Tahap Kekotoran	Ringan	Medium	Biasa	Yang Sangat
Tahap Basuh				

### **Vapour (wap) Touchpad** ( )

Pilih opsyen ini untuk menambah kira-kira 30 minit putaran di dalam wap semasa kitaran basuh. Wap membantu membuka gentian fabrik untuk membolehkan bahan perapi pakaian menanggalkan kotoran yang degil. Penunjuk opsyen ini akan menyala.

#### **NOTA:**

- Wap mungkin tidak kelihatan di dalam dram semasa kitaran basuh wap. Wap akan membentuk di bawah dram dan dibiarkan meningkat secara semula jadi ke dalam pakaian.
- Wap mungkin tiada semasa keseluruhan kitaran basuh wap.
- Fungsi wap adalah lebih separuh penuh cepak dengan muatan.
- Di penghujung kitaran wap pakaian akan menjadi lebih hangat, lembut dan tertanggal dari dram.

**i** Jika opsi wap dipilih, suhu bilas akan naik.

Semasa kitaran wap anda mungkin melihat wap keluar dari hos saliran mesin basuh, ini adalah biasa dan tidak perlu berasa cemas.

### **UltraMix (UltraCampur)** ( )

Apabila anda membuat pilihan ini, detergen diadunkan dan dilarutkan dalam air di dalam ruang “teknologi pracam-puran”. Ini mengaktifkan sepenuhnya kuasa basuhan detergen sebelum disiram ke atas pakaian anda.

### **i** **NOTA:**

- Disyorkan agar menggunakan pilihan ini dengan air suhu bilik kerana air suhu bilik juga berupaya melarutkan dan mencapai keberkesanan detergen yang lebih tinggi.
- Disebabkan ciri “UltraMix (  )”, yang meningkatkan pengaktifan bahan pencuci. Adalah disarankan untuk menggunakan hanya separuh daripada jumlah bahan pencuci yang biasa anda gunakan. Jika BUIH penuh di pintu kaca atau berlakunya berlebihan buih, ia bermakna sukatan bahan pencuci masih tinggi daripada kuantiti yang diperlukan. Dalam keadaan ini, sila kurangkan sukatan dengan sewajarnya.

## 3.6 Tetapan

### **Menyimpan Program Kegemaran ( ☆ )**

Tetapan program yang sering digunakan boleh disimpan (cth. Cotton, 60°C, 1200 rpm, dengan Prbasuh dan Bilas Tambahan). Untuk memprogram/memprogram semula Kegemaran dengan pilihan anda serta menyimpannya, sila ikut langkah-langkah seperti berikut:

1. Biarkan mesin berada dalam mod Sedia (Stand-by).
2. Pilih tetapan cucian yang anda kehendaki.
3. Untuk menyimpan program kegemaran, tekan pad sentuh “Temp” dan “Spin” pada masa yang sama sehingga paparan menunjukkan susunan kata “Program Saved” (Program Disimpan).

Untuk mendapatkan kembali program cucian kegemaran, tekan butang “Favourite ☆” (Kegemaran). Anda akan mendapat perakuan pada skrin program Kegemaran dimuat.







Anda boleh mendapatkan kembali program cucian kegemaran HANYA apabila mesin dalam mod pilihan program. Jika tidak, pilihan “Favourite” (Kegemaran) tidak akan memberi kesan.

### **Ciri Keselamatan Kanak-Kanak** ( )

Perkakas anda disediakan dengan KUNCI KESELAMATAN KANAK-KANAK yang membenarkan anda untuk meninggalkan perkakas tidak dijaga dengan pintu ditutup tanpa perlu risau kanak-kanak mungkin tercedera atau menyebabkan kerosakan kepada perkakas.

**i** Tetapkan pilihan ini selepas menekan pad sentuh “Start/Pause”.

Untuk menetapkan opsi Kenali Keselamatan Kanak-kanak:

- Untuk mengaktifkan fungsi ini, tekan pad sentuh “Rinse + (  ) dan Easy Iron (  ) pada masa yang sama sehingga paparan menunjukkan simbol “  ”.
- Semua pad sentuh adalah dikunci (kecuali butang “On/Off”).
- Untuk menyahaktifkan fungsi ini, tekan pad sentuh “Rinse + (  ) and Easy Iron (  ) pada masa yang sama sehingga simbol “  ” padam.
- Opsi ini berfungsi walaupun selepas perkakasan dimatikan.

### **Mendayakan/Menyahdayakan Pembaz Tamat Basuhan**

Tetapan ini membolehkan anda untuk mendayakan atau menyahdayakan pembaz apabila mesin program tamat. Sebagai contoh, anda mungkin mahu menyahdayakan pembaz ini apabila anda memulakan basuhan sewaktu masuk tidur, supaya apabila basuhan tamat kira-kira 1 jam kemudian, ia tidak akan mengganggu anda sepanjang malam.

**i** Bukan semua pembaz ralat dapat dinyahdayakan dengan seting ini, misalnya kerosakan yang kritikal.

Untuk menyahdayakan bunyi pembaz, tekan pad sentuh “Mudah Seterika (≡)” dan Prabasuhan (□)” pada masa yang sama selama 3 saat, dan tunggu bunyi “BIP, BIP”.

Untuk kembali ke konfigurasi lalai, tekan kedua-dua pad sentuh ini pada masa yang sama selama 3 saat, dan tunggu bunyi “BIP”.

### 3.7 Pad sentuh Mula/Jeda (▷||) dan Tambah Pakaian (↻)

Pad sentuh ini mempunyai 2 fungsi:

- **Mula/Jeda (▷||)**

Setelah anda memilih program dan pilihan yang diinginkan, tekan pad sentuh ini untuk memulakan mesin. Cahaya pandu Mula/Jeda akan berhenti berkelip dan kekal menyala sehingga paras air melebihi pinggir bawah pintu kemudian cahaya pandu akan PADAM. Jika anda telah membuat pilihan “Tunda Tamat”, pengiraan detik akan dimulakan dan ditunjukkan pada paparan.

Untuk mengganggu program yang sedang berjalan, tekan pad sentuh ini untuk menjedakan mesin, cahaya pandu Mula/Jeda akan berkelip.

Untuk memulakan semula program dari takat ia diganggu, tekan pad sentuh ini sekali lagi, cahaya pandu Mula/Jeda akan berhenti berkelip.

- **Tambah Pakaian (↻)**

**i** Anda hanya boleh menambah pakaian jika cahaya “Mula/Jeda” menyala.

Sewaktu program berjalan, anda boleh menambah pakaian dengan:

- Menekan pad sentuh “Mula/Jeda” untuk menjedakan program.
- Tunggu mesin berhenti sepenuhnya sebelum membuka pintu.
- Tambah pakaian dan tutup pintu.
- Sambung semula program dengan menekan pad sentuh “Mula/Jeda” sekali lagi.

## 4. SEBELUM PENGGUNAAN YANG PERTAMA

**i** Semasa pemasangan atau sebelum penggunaan pertama anda boleh melihat sedikit air di dalam mesin. Ini adalah air sisa yang tinggal dalam mesin selepas ujian yang berfungsi sepenuhnya di kilang untuk memastikan mesin itu diserahkan kepada pelanggan dalam keadaan yang sempurna dan tidak membimbangkan.

1. Pastikan sambungan elektrik dan air mematuhi arahan pemasangan.
2. Letakkan 2 liter air di dalam petak detergen untuk fasa basuhan. Ia mengaktifkan sistem salir.

3. Pilih kitar Cotton (Kapas) pada 90 °C, tanpa sebarang kain basuhan di dalam mesin, untuk mengeluarkan sebarang baki pengilangan dari dram dan tab kemudian mulakan mesin.

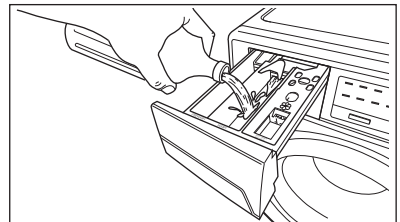

## 5. PENGGUNAAN HARIAN

### 5.1 Memuat Cucian

1. Buka bekalan arus air.
2. Pasangkan palam utama kepada soket utama.
3. Tekan butang On/Off untuk menghidupkan mesin basuh. Sentuh satu daripada IKON Program, untuk memilih program cucian yang dikehendaki.

**i** Untuk operasi penderia berat yang lebih tepat, aktifkan perkakas dan tetapkan program cucian **SEBELUM** memuat cucian di dalam dram. (Lihat halaman 40)

4. Buka pintu dengan menarik pemegang pintu perlahan-lahan ke luar. Periksa dan keluarkan objek (jika ada) yang boleh tersekat di dalam lipatan.

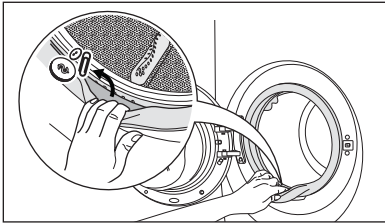

5. Masukkan pakaian ke dalam dram, satu persatu, sambil menggongcang-gongcangkannya seberapa banyak yang mungkin. (Rujuk kepada muka surat 51 "PETUA MEMBASUH")
6. Tutup pintu muatan.



#### **AWAS!**

Pastikan tiada kain cucian tertinggal diantara penutup dan pintu.

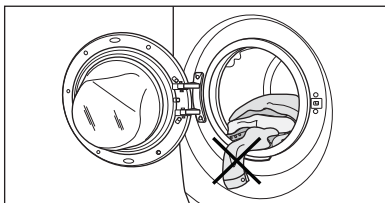

### 5.2 Mengguna Detergen dan Perapi Tambahan



**PENTING:** Sila baca arahan bahan pencuci di muka surat 53 sebelum penggunaan.

1. Laci Dispenser Detergen

Dispenser Detergen dibahagikan kepada tiga ruang.

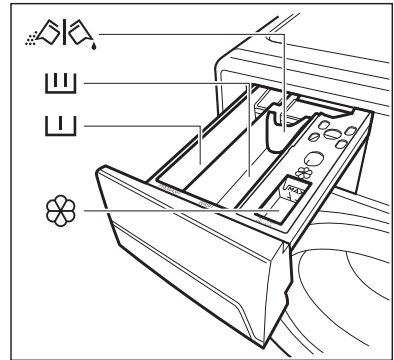

- Ruang "MAIN WASH"  
Ruang ini digunakan untuk detergen pada semua program.
- Ruang "PREWASH"  
Ruang ini hanya digunakan untuk detergen apabila Prabasuh dipilih.
- Ruang "SOFTENER"  
Ruang ini digunakan untuk perapi fabrik dan agen kanji.



Detergen Kekap

Flap untuk detergen serbuk atau cecair.



- Kedudukan bawah: untuk detergen cecair.
- Kedudukan atas: untuk detergen serbuk (tetapan kilang).





**i** Apabila anda menggunakan detergen cecair:

- Jangan gunakan detergen cecair yang bergelatin atau pekat.
- Jangan letakkan cecair lebih banyak daripada paras maksimum.
- Jangan tetapkan fasa "Prewash".
- Jangan tetapkan "Delay End".

2. Sukat detergen dan pelembut pakaian;

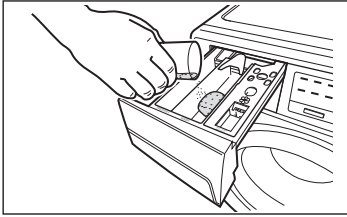
- Tarik keluar petak dispenser sehingga ia berhenti.
- Ukur sukatan detergen yang diperlukan, tuang ia ke dalam tempat basuhan utama.



- Jika anda mahu melakukan fasa "Prewash", tuangkannya ke dalam ruang yang bertanda "L".
- Jika perlu, tuangkan pelembut fabrik ke dalam bekas bertanda .

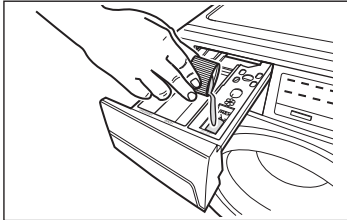

**i** Jumlah yang digunakan mesti tidak melebihi tanda "MAX" di dalam petak.

Jika anda menggunakan pelembut pekat, disarankan agar mencairkannya dengan air dahulu.

- Tutup laci perlahan-lahan.

**i** Selepas kitaran cucian selesai, sisa detergen, pelembut dan air mungkin berada di dalam kotak pendispens. Adalah disyorkan agar kotak pendispens dibersihkan dengan kerap untuk mengeluarkan sebarang sisa.

## 5.3 Tetapan Opsyen

1. Jika anda mahu cucian anda diputar atau gunakan suhu berlainan daripada yang disarankan oleh mesin basuh, tekan pad sentuh Putar "⌚" dan suhu "🌡" berulang kali untuk menukar kelajuan dan suhu putaran. Pilih dan tekan opsyen pad sentuh, jika anda inginkan kain basuhan anda dicuci dengan fungsi khas.

**i** NOTA

- Fungsi berlainan boleh digabungkan yang bergantung pada program yang dipilih.
- Jika anda membuat pilihan yang tidak serasi dengan program basuhan yang ditetapkan, mesej "Not Available" akan berkelip dan bunyi bip kedengaran.

2. Jika anda mahu mengurangkan masa membasuh, tekan pad sentuh "Time Manager (⌚)" berulang kali untuk mengurangkan masa membasuh. Lihat panduan Pengurus Masa (⌚) di muka surat 45.

Jika anda mahu menundakan permulaan program pembasuhan, tekan pad sentuh "Delay End (⌚)" berulang kali untuk memilih masa tunda mesin basuh anda.

## 5.4 Memula Program (▶||)

Untuk memulakan program, tekan pad sentuh Start/Pause (▶||), lampu panduan yang berkaitan akan berhenti berkelip dan tempoh program akan dipaparkan pada skrin.

**i** NOTA

- Jika anda menekan sebarang pad sentuh sewaktu program sedang beroperasi, paparan akan menunjukkan mesej "Not Available" dan mengeluarkan bunyi bip. (kecuali pad sentuh Mula/Jeda dan butang Hidup/Mati)

**i** NOTA: Selepas kira-kira 15 minit dari permulaan program:

- Perkakas akan melaras secara automatik tempoh program yang dipilih mengikut jenis dan saiz muatan.
- Paparan akan menunjukkan tempoh program yang dilaras.

## 5.5 Gangguan Program

- Untuk menjeda tekan Start/Pause. Penunjuk akan mula berkelip.
- Tekan Start/Pause sekali lagi. Program akan diteruskan.

## 5.6 Menukar Program

Menukar program yang sedang berjalan hanya boleh dilakukan dengan mematikan suis perkakas.

- Tekan butang "On/Off" untuk membatalkan program dan matikan suis perkakas.
- Tekan butang "On/Off" sekali lagi untuk memulakan perkakas.

Sekarang, anda boleh menetapkan program cucian yang baru.



Perkakas tidak akan mengeluarkan air.

## 5.7 Menukar Opsyen

Selepas program bermula, hanya beberapa opsyen boleh ditukarkan.

1. Tekan pad sentuh "Start/Pause". Penunjuk akan mula berkelip.
2. Pilih dan tukar opsyen.
3. Tekan "Start/Pause" sekali lagi. Program akan diteruskan.

## 5.8 Membuka Pintu

Semasa program atau "Delay End" sedang beroperasi, pintu perkakas akan dikunci dan paparan menunjukkan penunjuk "—□". Tetapkan mesin basuh ke PAUSE (JEDA) dengan menekan pad sentuh "Start/Pause" (Mula/Jeda). Tunggu sehingga penunjuk kunci pintu "—□" padam, barulah pintu boleh dibuka.

Jika penunjuk kunci pintu "—□" tidak padam, ini bermakna mesin sudah mula memanas dan paras air berada di atas hujung bawah pintu atau dram sedang berputar. Dalam hal ini pintu TIDAK BOLEH dibuka. Jika anda perlu membukanya, anda perlu mengalirkan air untuk membuka pintu.



**Jika ia adalah satu kes kecemasan yang perlu membuka pintu serta-merta. Sila baca "Membuka Pintu Mesin Semasa Kecemasan" pada halaman 61.**

## 5.9 Di Penghujung Program

- Perkakas berhenti secara automatik.
- Isyarat akustik akan beroperasi.
- Paparan akan menunjukkan "□".
- Penunjuk pad sentuh Start/Pause (Mula/Jeda) padam.
- Penunjuk kunci pintu "—□" padam.
- Keluarkan pakaian daripada perkakas. Pastikan dram dikosongkan.
- Biarkan pintu terbuka, untuk mengelakkan kulat dan bau.
- Tutup pili air.



Di penghujung program, baki masa boleh menurun secara tiba-tiba daripada 7 minit atau kurang kepada 0 kerana terlebih anggaran masa semasa fasa penderiaan muatan. Dalam sesetengah kes, (muatan seimbang) masa program boleh menjadi lebih pendek daripada masa yang dianggarkan selepas fasa penderiaan muatan selesai. Perkara begini biasa berlaku pada mesin dan bukan sesuatu yang perlu dibimbangkan kerana ini tidak mengganggu prestasi.

## 5.10 Apabila Program Membasuh Selesai, Tetapi Terdapat Air Di Dalam Dram

(Penggunaan Pilihan "Rinse Hold" atau "Extra Silent")

- Dram berputar secara kerap untuk mengelakkan renyuk pada pakaian.
- Penunjuk "Mula/Jeda" berkelip untuk mengingatkan anda untuk mengalirkan air.
- Penunjuk pintu kunci "—□" dihidupkan. Pintu akan tetap dikunci.

Anda mesti mengeringkan air untuk membuka pintu.

### Untuk menyalurkan air:

1. Tekan pad sentuh "Mula/Jeda ▷||". Perkakas menyalurkan air dan memutar pada kelajuan putaran maksimum bagi program yang dipilih. Secara alternatif, sebelum menekan pad sentuh "Mula/Jeda", anda boleh menekan pad sentuh "Spin Ⓞ" untuk menukar kelajuan putaran. Anda boleh memilih "No Spin", jika anda mahu mesin menyalurkan air sahaja, kemudian tekan pad sentuh Mula/Jeda. Perkakas akan menyalurkan air dan memutar.
2. Apabila program selesai dan penunjuk pintu kunci "→" padam, anda boleh membuka pintu.
3. Tekan butang "On/Off" untuk menyahaktifkan perkakas.

#### **NOTA:**

Selepas lebih kurang 18 jam jika anda tidak menekan pad sentuh Mula/Jeda, perkakas akan menyalurkan air dan memutar secara automatik (kecuali bagi program Wul Tangan).

## 5.11 AUTO Off Mod

Pilihan AUTO Off Fungsi mengurangkan penggunaan tenaga dengan menyahaktifkan perkakas apabila:

- Anda tidak menggunakan perkakas selama 5 minit sebelum butang "Start/Pause" ditekan.
-  Tekan butang "On/Off" untuk mengaktifkan semula perkakas.
- Selepas 5 minit program basuh selesai.
  - Tekan butang "On/Off" untuk mengaktifkan semula perkakas. Paparan menunjukkan akhir program set terakhir.
  - Sentuh sebarang pad sentuh paparan akan menunjukkan program tetapan terakhir dan opsiyen.
  - Sentuh touchpad program ini sekali lagi untuk menetapkan kitaran baru.

## 6. PETUA MEMBASUH

### 6.1 Mengasing Pakaian

Ikut simbol kod cucian pada setiap label pakaian dan arahan cucian pengilang. Asingkan pakaian seperti berikut: putih, berwarna, sintetik, bahan halus, bahan wul.

### 6.2 Suhu

90°C	Bagi kain kapas dan linen dengan kotoran biasa (cth. alas meja teh, tuala, alas meja, cadar...).
60°C 50°C	Bagi kotoran biasa, pakaian mudah luntur (cth. kemeja, baju tidur, pijama...) daripada linen, kapas atau gentian sintetik dan untuk kain kapas yang ringan kotoran (cth.pakaian dalam).
40°C 30°C Sejuk	Bagi item halus (cth. langsir net), pakaian bercampur termasuk gentian sintetik dan wul dengan label «wul baru tulen, boleh dibasuh mesin, tidak mengecut.

### 6.3 Sebelum Memuat Pakaian

- Pastikan tiada objek logam tertinggal di dalam pakaian (cth. klip rambut, pin keselamatan, jarum).
- Butangkan sarung bantal, tutup zip, cangkuk dan butang ketap. Ikatkan sebarang tali pinggang atau pita yang panjang.
- Cuci coli, sarung kaki dan pakaian lembut lain di dalam beg cucian yang boleh anda beli di pasaraya.

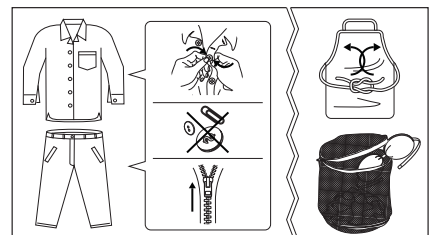

- Pastikan anda mencuci pengumpul lin secara berasingan daripada pengeluar lin.
- Jangan basuh pakaian putih dan berwarna bersama-sama. Pakaian putih boleh kehilangan "keputihannya" dalam cucian.
- Pakaian berwarna yang baru mungkin luntur dalam basuhan pertama; maka ia perlu dibasuh berasingan pada kali pertama.
- Tanggalkan tanda kotoran degil sebelum membasuh.
- Bahagian yang sangat kotor hendaklah digosokkan dengan detergen khas atau pes detergen. Langsir hendaklah diperlakukan dengan cermat. Tanggalkan cangkuk atau ikatkannya di dalam beg atau jaring.

## 6.4 Muatan Maksimum

Beban maksimum yang disarankan dinyatakan di dalam carta program. Peraturan umum:

Kapas, linen:	dram penuh tetapi tidak terlalu padat;
Sintetik:	dram tidak lebih daripada separuh penuh;
Bahan halus dan wul:	dram tidak lebih daripada sepertiga penuh.

Membasuh pakaian dengan beban maksimum menghasilkan penggunaan air dan tenaga yang paling cekap. Bagi pakaian yang sangat kotor, kurangkan saiz muatan.

## 6.5 Menanggalkan Kotoran

Tanda kotoran degil mungkin tidak dapat ditanggalkan hanya dengan air dan detergen. Oleh itu, adalah dinasihatkan untuk merawatnya terlebih dahulu sebelum membasuh.

**Darah:** bersihkan kotoran yang masih baru dengan air sejuk. Untuk kotoran kering, rendam semalaman di dalam air dengan detergen khas kemudian gosok dengan sabun dan air.

**Cat berasaskan minyak:** lembapkan dengan penghapus kotoran benzin, bentangkan pakaian di atas kain lembut dan pedapkan kotoran tersebut; bersihkan beberapa kali.

**Kotoran gris kering:** lembapkan dengan turpentin, bentangkan pakaian tersebut di atas permukaan yang lembut dan pedapkan tanda kotoran dengan hujung jari dan sehelai kain kapas.

**Karat:** asid oksalik dilarutkan dalam air panas atau produk penghapus karat digunakan dalam air sejuk. Berhati-hati dengan tanda karat yang sudah lama kerana struktur selulosanya telah rosak dan pakaian mudah berlubang.

**Kotoran kulat:** bersihkan dengan peluntur, bilas dengan betul(kain putih dan kain berwarna tahan luntur sahaja).

**Rumput:** letak sedikit sabun dan bersihkan dengan peluntur (kain putih dan kain berwarna tahan luntur sahaja).

**Pena mata bola dan gam:** lembapkan dengan aseton(\*), bentangkan di atas kain lembut dan pedapkan tanda kotoran itu.

**Gincu:** lembapkan dengan aseton (\*) seperti di atas, kemudian bersihkan kotoran dengan spirit bermetil. Hapuskan sisa tanda daripada kain putih dengan peluntur.

**Wain merah:** rendam dalam air dan detergen, bilas dan bersihkan dengan asid asetik atau sitrik, kemudian bilas. Bersihkan sebarang tanda sisa dengan peluntur.

**Dakwat:** bergantung pada jenis dakwat, lembapkan pakaian dahulu dengan aseton (\*), kemudian dengan asid asetik; bersihkan sebarang tanda sisa pada pakaian putih dengan peluntur dan kemudian bilas dengan bersih.

**Kotoran tar:** bersihkan dahulu dengan penghapus kotoran, spirit bermetil atau benzin, kemudian gosokkannya dengan pes detergen.

(\* ) jangan gunakan aseton pada sutera buatan.

## 6.6 Jenis Bahan Pencuci dan Kuantiti Bahan Pencuci

Mesin basuh ini memerlukan penggunaan bahan pencuci berbuih rendah bagi menghalang masalah buih berlebihan, hasil cucian yang tidak memuaskan dan kerosakan kepada mesin. Bahan pencuci berbuih rendah yang direka untuk mesin basuh muatan depan mempunyai label seperti “Muatan Hadapan”, “kecekapan tinggi”, “HE”, seperti “Cold Power for Front Loaders” or “Matic”.

**Jangan menggunakan jenis bahan pencuci yang salah, seperti bahan pencuci untuk mesin muatan Atas, bahan pencuci untuk Cucian Tangan atau produk-produk berasaskan sabun untuk mesin basuh muatan depan anda. Ini boleh menyebabkan buih berlebihan, masa kitaran lebih lama, kelajuan putaran yang rendah, pembilasan yang teruk dan enjin yang terlebih muatan.**

### Kuantiti bahan pencuci untuk digunakan

Pilihan bahan pencuci dan penggunaan kuantiti yang betul bukan sahaja memberi kesan kepada prestasi cucian anda, malah membantu mengelakkan pembaziran dan melindungi persekitaran.

Walaupun boleh diuraikan melalui tindakan biologi, bahan pencuci mengandungi bahan-bahan dimana, dalam kuantiti yang banyak, boleh merosakkan keseimbangan halus alam sekitar.

### Pilihan dan kuantiti bahan pencuci bergantung kepada ;

- jenis fabrik (halus, bulu, kapas, dan lain-lain.) ;
- warna pakaian;
- saiz muatan;
- tahap kotoran;
- suhu cucian; dan
- kekuatan air yang digunakan.

Kekerasan air dikelaskan mengikut “tahap” kekerasan.

Maklumat tentang kekerasan air dalam kawasan anda boleh diperolehi daripada syarikat bekalan air yang berkaitan, atau dari pihak berkuasa tempatan anda.

Anda mungkin perlu mencuba menggunakan kuantiti bahan pencuci mengikut setiap arahan pengeluar produk kemudian bandingkan hasil cucian dengan senarai di bawah dan sesuaikan jumlah bahan pencuci untuk masa akan datang dengan sewajarnya.

### Serbuk pencuci yang tidak mencukupi menyebabkan:

- muatan cucian bertukar menjadi kelabu,
- pakaian berminyak.

### Serbuk pencuci yang terlalu banyak menyebabkan:

































- berbuih-buih,
- kesan cucian berkurang,
- pembilasan kurang baik

### Kurangkan bahan pencuci jika:

- anda mencuci muatan yang sedikit,
- cucian tidak begitu kotor
- jumlah buih yang banyak semasa mencuci.

## 7. SIMBOL KOD BASUH ANTARABANGSA

 Simbol ini terdapat pada label pakaian, untuk membantu anda memilih cara terbaik membersihkan cucian anda.

 <b>Cucian bertenaga</b>	 Suhu maksimum cucian 95 °C	 Suhu maksimum cucian 60 °C	 Suhu maksimum cucian 40 °C	 Suhu maksimum cucian 30 °C	 Cucian tangan	 JANGAN cuci
 <b>Cucian lembut</b>			 			
 <b>Meluntur</b>	 Meluntur dalam air sejuk			 JANGAN meluntur		
 <b>Menyeterika</b>	 Seterika panas maks. 200 °C	 Seterika hangat maks. 150 °C	 Seterika suam maks. 110 °C	 JANGAN seterika		
 <b>Cucian kering</b>	 Cucian kering dalam semua pelarut	 Cucian kering dalam perkloritena, petrol, alkohol tulen, R 111 & R 113	 Cucian kering dalam petrol, alkohol tulen dan R 113	 JANGAN cuci kering		
 <b>Mengering</b>	 Bentangkan	 Di ampaijan	 Penyidai pakaian	 Suhu tinggi	 Suhu rendah	 JANGAN gunakan mesin pengering

## 8. PENJAGAAN DAN PEMBERSIHAN

 **AMARAN!** Anda mesti MEMUTUSKAN SAMBUNGAN bekalan elektrik daripada perkakas, sebelum anda boleh menjalankan pembersihan atau kerja penyelenggaraan.

### 8.1 Pembersihan Luar

Bersihkan perkakas hanya dengan sabun dan air suam. Keringkan semua permukaan sepenuhnya.

 **AWAS!** Jangan gunakan alkohol, pelarut atau produk bahan kimia.

### 8.2 Menanggalkan Kesan Kapur

Air yang biasa kita gunakan mengandungi kapur. Adalah menjadi idea yang baik untuk kadang kala menggunakan serbuk pelembut air dalam mesin.

Lakukan ini secara berasingan daripada cucian pakaian, dan mengikut arahan-serbuk pelembut yang dikeluarkan oleh kilang. Ini akan membantu mencegah pembentukan deposit kapur.

### 8.3 Selepas Setiap Cucian

Biarkan pintu terbuka sebentar. Ini membantu mencegah kulat dan bau lembap yang terbentuk di dalam perkakas. Membiarkan pintu terbuka selepas pembasuhan juga akan membantu memelihara kedap pintu.

## 8.4 Basuhan Penyelenggaraan Dengan Program “Tub Clean”

Dengan penggunaan pembasuhan suhu rendah, ada kemungkinan sisa termendap di dalam dram. Kami mengesyorkan agar program “Pembersihan Tab” digunakan secara tetap untuk membuang sebarang sisa.

### Untuk menjalankan basuhan penyelenggaraan:

- Dram hendaklah kosong daripada kain kotor.
- Pilih program “Tub Clean”.
- Gunakan sukatan biasa detergen, ia mesti serbuk yang mempunyai sifat biologi.
- Tekan Mula/Jeda untuk memulakan program.

## 8.5 Membersih Petak Dispenser

Petak dispenser serbuk cucian dan perapi tambahan harus kerap dibersihkan. Keluarkan petak dengan menekan selak ke bawah dan teriknya keluar. Bersihkan dengan air paip, untuk membuang kesan serbuk yang terkumpul.

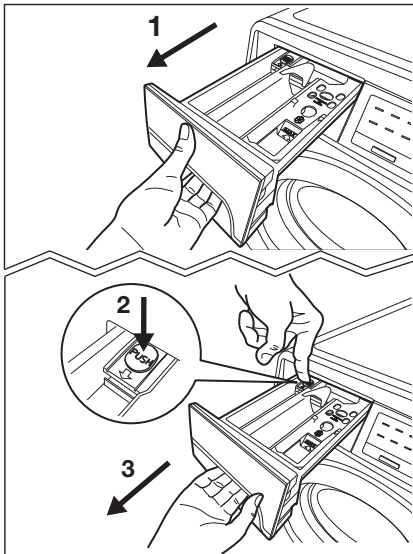

Untuk memudahkan pembersihan, bahagian atas petak perapi tambahan harus dikeluarkan.

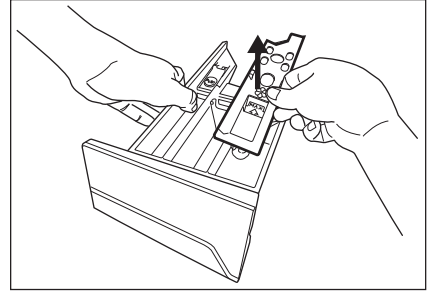

## 8.6 Membersih Ceruk Petak

Selepas petak dikeluarkan, gunakan berus kecil untuk membersihkan bahagian ceruk, pastikan semua sisa serbuk cucian dibuang dari atas dan bawah ceruk. Letak semula petak dan jalankan program bilas tanpa sebarang pakaian di dalam dram.

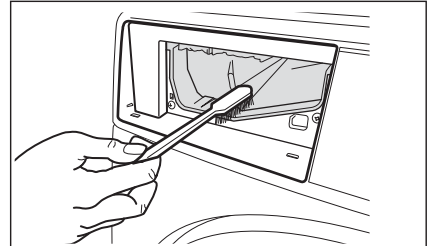

## 8.7 Membersih Pam

**i** Periksa pam aliran air keluar dengan kerap dan pastikan ia bersih.

### Bersihkan pam jika:

- Perkakas tidak mengeringkan air.
- Dram tidak berputar.
- Perkakas membuat bunyi pelik kerana tersumbat pada pam air keluar.
- Paparan menunjukkan kod awas/peringatan kerana masalah pada penyaliran air keluar.

**! AMARAN!**

1. Cabutkan sambungan plag utama daripada soket utama.

2. Jangan keluarkan penapis semasa perkakas sedang beroperasi. Jangan bersihkan pam aliran air keluar jika air di dalam perkakas panas. Air mesti sejuk sebelum anda membersihkan pam aliran air keluar.

**Untuk membersihkan pam aliran air keluar:**

1. Buka pintu pam aliran air keluar.

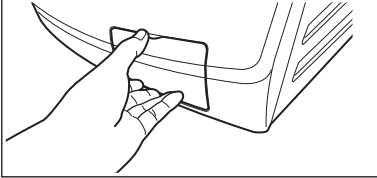

2. Tarik selak ke bawah, kemudian tekan kaki di kedua-dua penutup bersama-sama dan tarik keluar (seperti gambar).

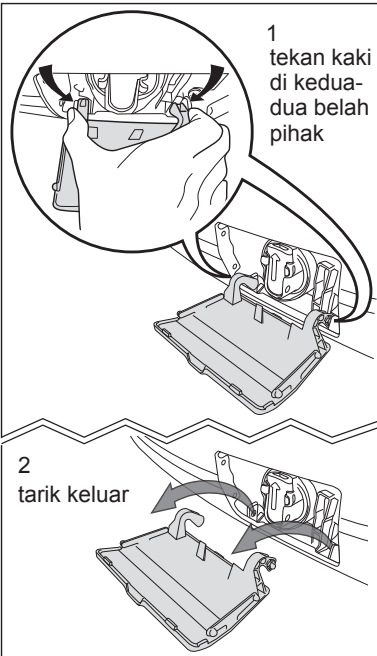
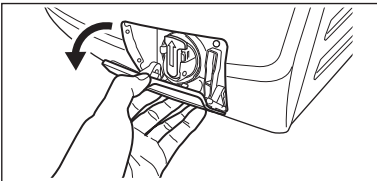

3. Letakkan bekas di bawah ceruk pam aliran air keluar untuk mengumpul air yang mengalir keluar.

Tekan dua tuil dan tarik salur ke hadapan untuk membolehkan air mengalir keluar.

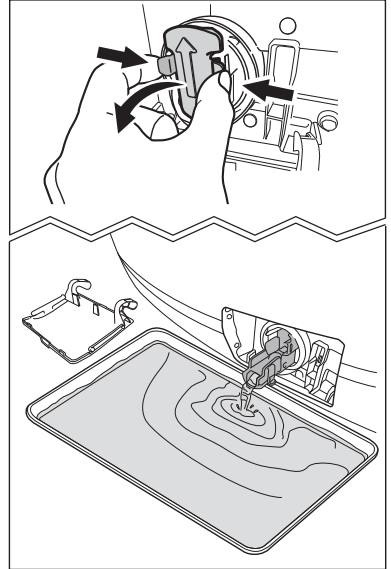

4. Apabila bekas penuh dengan air, letak semula salur air keluar dan kosongkan bekas tadi. Lakukan langkah 3 sekali lagi sehingga tiada lagi air mengalir keluar daripada pam air keluar.

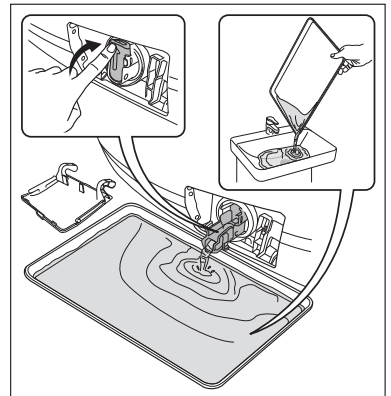



5. Letakkan semula salur air keluar dan pusingkan penapis untuk mengeluarkannya.

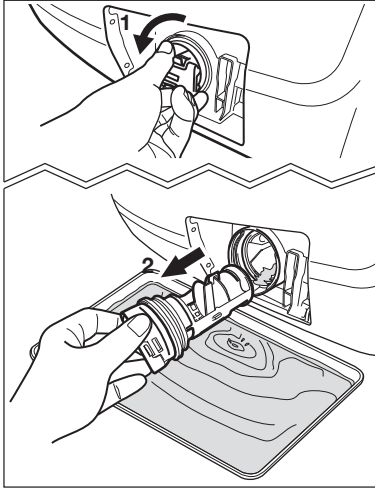

6. Keluarkan sisa bulu dan objek daripada penapis pam (jika ada).

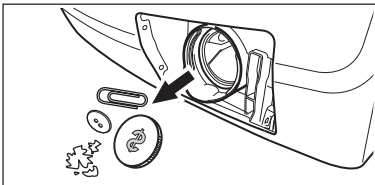

7. Pastikan impeler pam boleh dipusing. Jika ini tidak, hubungi pusat servis.

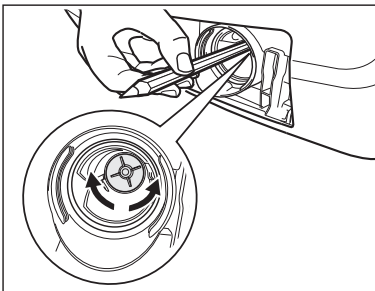

8. Bersihkan penapis di bawah air paip.

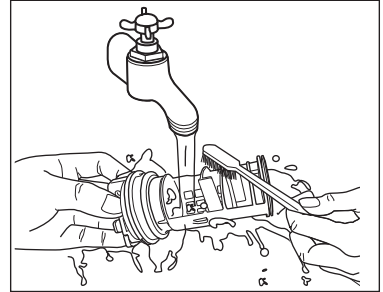

9. Letak semula penapis ke dalam pam mengikut panduan khas. Pastikan anda mengetat semula penapis dengan betul untuk mencegah kebocoran.

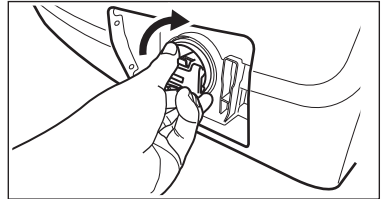

10. Letak semula selak dan tutup pintu pam aliran air keluar.

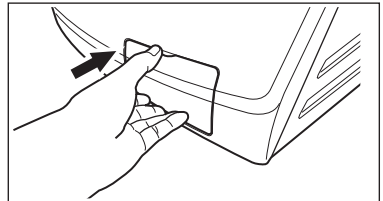

## 8.8 Membersih Penapis Aliran Air Masuk

Jika air anda keras atau mengandungi kesan deposit kapur, penapis aliran air masuk mungkin tersumbat. Oleh itu idea yang baik ialah membersihkannya dari masa ke semasa.

**Untuk membersihkan penapis aliran air masuk:**

1. Tutup pili air.
2. Keluarkan hos aliran air masuk daripada pili air.
3. Bersihkan penuras dalam hos dengan berus keras.

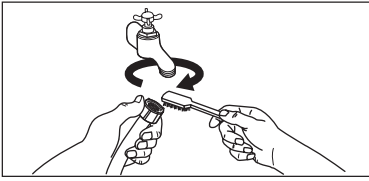

4. Keluarkan hos aliran air masuk di belakang perkakas.
5. Bersihkan penapis di dalam injap dengan berus kasar atau tuala.

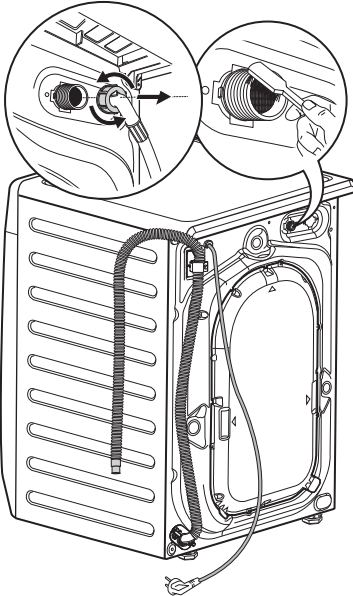

6. Pasangkan semula hos aliran air masuk. Pastikan sambungan ketat untuk mengelak kebocoran.

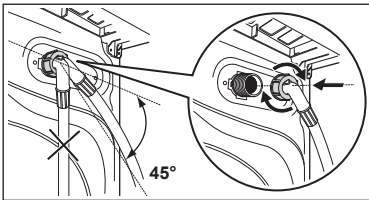

7. Buka pili air.

## 8.9 Langkah Berwaspada Fros

Jika perkakas dipasang di tempat yang suhunya boleh turun sehingga kurang daripada 0 °C, buang baki air di dalam hos salur masuk dan pam saliran.

### Saliran Kecemasan

1. Tanggalkan palam sesalur daripada soket sesalur. Tutup pili air.
2. Tanggalkan hos salur masuk air.
3. Tanggalkan hos salir dari sokongan belakang dan cabut pencangkuk dari sink atau spigot.

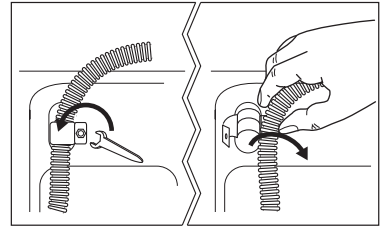

4. Letakkan hujung salir dan hos saluran masuk di dalam bekas. Biarkan air menyalir keluar daripada hos.

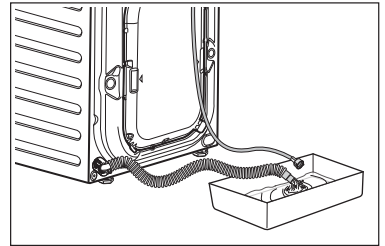

5. Apabila tiada lagi air mengalir, pasang hos saluran masuk dan hos salir sekali lagi.

### ! NOTA

Pastikan suhu-lebih daripada 0 °C sebelum anda menggunakan semula perkakas.

## 9. PENYELESAIAN MASALAH

### 9.1 Kegagalan Kemungkinan

Sesetengah masalah tertentu adalah berpunca daripada kurang penyelenggaraan yang mudah atau kesilapan yang boleh diselesaikan dengan mudah tanpa menghubungi jurutera. Sebelum menghubungi Pusat Servis tempatan anda, sila jalankan pemeriksaan yang disenaraikan di bawah.

Setelah masalah tersebut diselesaikan, tekan butang "START/PAUSE" untuk memulakan semula program. Jika masalah masih berlarutan setelah semua sudah diperiksa, hubungi Pusat Servis tempatan anda.



**AWAS!** Nyahaktifkan perkakas sebelum anda melakukan cek.

#### Kod Penggera:

<b>E10</b>	Mesin tidak mengisi air.
<b>E20</b>	Mesin tidak menyalir air.
<b>E40</b>	Pintu tidak ditutup atau pintu tidak ditutup dengan betul. Sila semak pintu!
<b>E40</b>	Bekalan kuasa utama tidak stabil. Tunggu sehingga bekalan kuasa utama stabil kembali dan mesin akan bermula operasi secara automatik.
<b>E91</b>	Tiada komunikasi antara unsur-unsur elektronik perkakas. Matikan dan hidupkan semula.

Malfungsi	Kemungkinan punca => Penyelesaian
<b>Mesin basuh tidak boleh dimulakan:</b>	• Pintu tidak ditutup. (Kod ralat: E4□) => Tutup pintu dengan rapi.
	• Plag tidak dimasukkan dengan betul ke dalam soket kuasa. => Masukkan plag ke dalam soket kuasa.
	• Tiada bekalan kuasa di soket. => Sila periksa pemasangan elektrik domestik anda.
	• Butang Start/Pause tidak ditekan. => Tekan butang Start/Pause.
	• Delay Start (☺) telah dipilih. => Jika pakaian mahu dicuci segera, batalkan "Delay End".
	• Bekalan kuasa utama tidak stabil. (Jika kod E4□ dipaparkan) => Tunggu sehingga bekalan kuasa utama stabil kembali dan mesin akan bermula operasi secara automatik.
<b>Mesin tidak mengisi air:</b>	• Pili air tertutup. (Kod ralat: E 1□) => Buka pili air.
	• Hos air masuk tertindih atau terpiuh. (Kod ralat: E 1□) => Periksa sambungan hos air masuk.
	• Penuras dalam hos air masuk tersumbat. (Kod ralat: E 1□) => Bersihkan penuras hos air masuk.
	• Pintu tidak ditutup dengan betul. (Kod ralat: E4□) => Tutup pintu dengan rapi
<b>Mesin mengisi kemudian terus menyalirkan:</b>	• Hujung hos saliran terlalu rendah. (Kod ralat: E 1□) => Sila rujuk perenggan berkenaan di bahagian "Penyaliran Air".

Malfungsi	Kemungkinan punca => Penyelesaian
<b>Mesin tidak menyalirkan air dan/atau tidak memutar:</b>	• Hos saliran tertindih atau terpiuh. (Kod ralat: E20) => Periksa sambungan hos penyaliran.
	• Pam saliran tersumbat. (Kod ralat: E20) => Bersihkan penuras saliran.
	• Opsyen "Extra Silent" atau "Rinse Hold" telah dipilih. => Tekan Mula/Jeda untuk mengalirkan air. atau Pilih program putaran (Spin).
	• Pakaian tidak diagihkan sama rata di dalam dram. => Jeda mesin dan agihkan semula pakaian secara manual.
<b>Terdapat air di atas lantai:</b>	• Terlalu banyak detergen atau detergen tidak sesuai digunakan (mengeluarkan terlalu banyak buih). => Kurangkan kuantiti detergen atau gunakan yang lain. (Lihat halaman 53)
	• Periksa sama ada terdapat kebocoran dari salah satu pemasangan hos air masuk. Kebocoran itu kadang tala sukar dilihat kerana air mengalir hos; periksa sama ada hos itu lembap. => Periksa sambungan hos air masuk.
	• Hos saliran rosak. => Hubungi pusat perkhidmatan kami.
<b>Hasil cucian yang tidak memuaskan:</b>	• Detergen tidak mencukupi atau tidak sesuai untuk digunakan. => Tingkatkan kuantiti detergen atau gunakan yang lain. (Lihat halaman 53)
	• Tanda kotoran degil tidak dibersihkan terlebih dahulu sebelum membasuh. => Gunakan produk komersil untuk merawat kesan kotoran yang degil.
	• Suhu yang betul tidak dipilih. => Periksa sama ada anda telah memilih suhu yang betul.
	• Muatan pakaian berlebihan. => Kurangkan muatan.
<b>Pintu tidak dapat dibuka:</b>	• Program masih berjalan. => Tunggu sehingga putaran basuhan terakhir.
	• Terdapat air di dalam dram. => Anda hendaklah menyalirkan air untuk membuka pintu (rujuk "Membuka Pintu" pada muka surat 50).
	• Masalah ini mungkin disebabkan oleh kegagalan fungsi mesin basuh. => Sila hubungi Talian Khidmat Pelanggan kami. Jika anda perlu buka pintu mesin, sila baca perenggan "Membuka Pintu Mesin Semasa Kecemasan" pada halaman yang seterusnya.
<b>Mesin bergegar atau bunyinya bisings:</b>	• Bolt pengangkutan dan pembungkusan belum dikeluarkan. => Periksa supaya pemasangan perkakas dibuat dengan betul.
	• Kaki penyokong belum dilaraskan lagi. => Periksa supaya pengarasannya perkakas dibuat dengan betul.
	• Pakaian tidak diagihkan sama rata di dalam dram. => Jeda mesin dan agihkan semula pakaian secara manual.
	• Jumlah pakaian di dalam dram terlalu sedikit. => Muatkan lebih banyak pakaian.
	• Lantai tidak stabil cth. lantai kayu. => Rujuk perenggan berkenaan dalam bahagian "Pemasangan".
<b>Masa kitaran lebih lama daripada yang dipaparkan:</b>	• Detergen melebihi dos. => Kurangkan kuantiti detergen atau gunakan yang lain. (Lihat halaman 53)
	• Mesin tidak seimbang. => Agihkan semula pakaian secara manual di dalam dram dan mulakan fasa putaran sekali lagi.

Malfungsi	Kemungkinan punca => Penyelesaian
<b>Kitaran ini adalah lebih pendek daripada masa yang dipaparkan.</b>	<ul style="list-style-type: none"> <li>• Perkakas mengira masa yang baru mengikut beban pakaian.</li> </ul>
<b>Putaran bermula lambat atau mesin tidak berputar:</b>	<ul style="list-style-type: none"> <li>• Peranti pegasan ketidakseimbangan elektronik telah menyela kerana pakaian tidak diagihkan sama rata di dalam dram. Pakaian diagihkan semula melalui putaran balikan dram. Hal ini mungkin berlaku beberapa kali sebelum ketidakseimbangan hilang dan pemutaran normal dapat disambungkan semula. Jika, selepas 10 minit, pakaian masih belum diagihkan sama rata di dalam dram, mesin tidak akan berputar. Dalam kes sebegini, sebarikan semula muatan secara manual dan pilih program putar. =&gt; Jeda mesin dan agihkan semula pakaian secara manual.</li> </ul>
<b>Mesin mengeluarkan bunyi pelik:</b>	<ul style="list-style-type: none"> <li>• Mesin tidak dipasang dengan betul. =&gt; Pastikan peletakan aras perkakas adalah betul. Rujuk pada "Pemasangan".</li> <li>• Bolt atau bungkusan transit tidak dikeluarkan. =&gt; Pastikan bungkusan dan/atau bolt transit dikeluarkan. Rujuk pada "Mengeluarkan".</li> <li>• Muatan terlalu kecil. =&gt; Tambah lebih banyak pakaian ke dalam dram.</li> </ul>
<b>Tiada air kelihatan di dalam dram:</b>	<ul style="list-style-type: none"> <li>• Mesin yang berasaskan teknologi moden beroperasi secara sangat ekonomik dengan menggunakan jumlah air yang sangat sedikit tanpa menjejaskan prestasi.</li> </ul>

## 9.2 Membuka Pintu Mesin Semasa Kecemasan

Pada masa kecemasan apabila mesin mengalami kegagalan fungsi dan pintu dikunci. Mesin akan meneruskan program basuh apabila bekalan elektrik kembali. Jika pintu dikunci disebabkan oleh kegagalan fungsi mesin, pintu boleh dibuka dengan pembukaan pintu semasa kecemasan.

**Sebelum pintu dibukakan:**



**AMARAN!**

Pastikan suhu air dan pakaian di dalam mesin tidak panas. Sila tunggu sehingga suhu air dingin.



**AMARAN!**

Pastikan tab basuh tidak berputar. Tunggu sehingga tab basuh berhenti.



**AMARAN!**

Pastikan paras air di dalam tab basuh tidak tinggi. Sila buat pengaliran air kecemasan. (rujuk kepada "Saliran Kecemasan" pada halaman 58)

**Untuk membuka pintu semasa kecemasan, sila:**

1. Tekan butang "On/Off" untuk memadamkan mesin.
2. Cabutkan bekalan elektrik.
3. Buka pintu penapis.
4. Tarik suis pembukaan pintu kecemasan (objek merah) ke bawah dan pada masa yang sama, buka pintu mesin basuh.

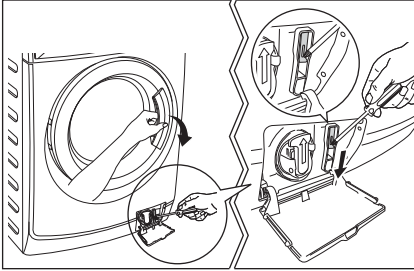

5. Keluarkan pakaian.
6. Tutup pintu penapis.

**i** Jika anda tidak dapat mengenal pasti atau menyelesaikan masalah, hubungi pusat perkhidmatan kami.

Sebelum menghubungi kami, catat model, nombor siri dan tarikh pembelian mesin anda: Pusat Perkhidmatan akan memerlukan maklumat ini.

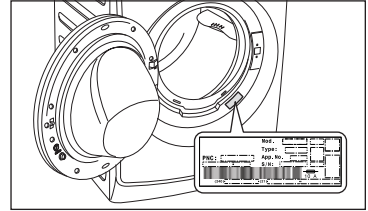

## 10. DATA TEKNIKAL

Dimensi (Tinggi / Lebar / Dalam)	85 X 60 X 66.9 cm	
Bekalan kuasa (Voltan / Frekuensi)	220-240 V / 50 Hz	
Jumlah kuasa	2100 W	
Perlindungan fuis minimum	10 A	
Tekanan bekalan air (Maksimum / Minimum)	0.8 MPa / 0.05 MPa	
Beban maksimum (pakaian kering)	Cottons	11 Kg
	Mixed	4 Kg
	Delicates	4 Kg
	Daily 60	5.5 Kg
	Quick 18	1.5 Kg
	Refresh	1.5 Kg
	Baby Care	4 Kg
	Sports	2.5 Kg
	Wool	2 Kg
	Energy Saver	11 Kg
	Spin	11 Kg
Rinse + Spin	11 Kg	
Bedding	3 Kg	
Heavy Duty	11 Kg	
Kelajuan putaran (Maksimum / Minimum)	1400 rpm / 400 rpm	

# 11. PEMASANGAN

## 11.1 Mengeluarkan



### AWAS!

Semua bolt pengangkutan dan bahan pembungkusan mesti dikeluarkan sebelum menggunakan perkakas. Anda dinasihatkan supaya menyimpan semua peranti pengangkutan supaya dapat dipasang semula jika mesin perlu diangkut lagi nanti.

1. Gunakan sarung tangan. Potong dan keluarkan empat memotong tali seperti yang ditunjukkan.

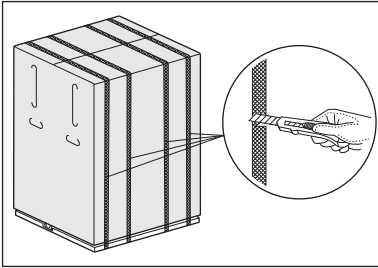

2. Buang kotak karton. Tanggalkan bahan bungkusan polisterin. Tanggalkan beg plastik yang menutup mesin.

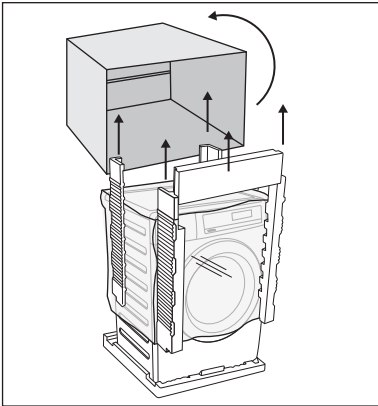

3. Buka pintu. Keluarkan kepingan polistren daripada pengedap pintu dan semua barang dari dram.

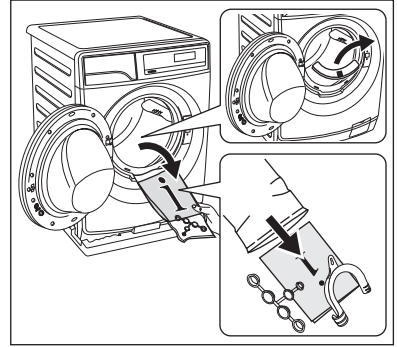

4. Letakkan salah satu elemen bungkusan polisterin di atas lantai di belakang perkakas. Dengan berhati-hati letakkan perkakas dengan bahagian belakang di atasnya. Pastikan tidak merosakkan hos.

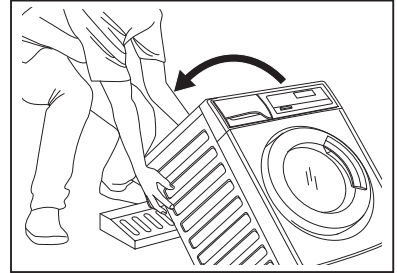

5. Tanggalkan dasar polisterin.

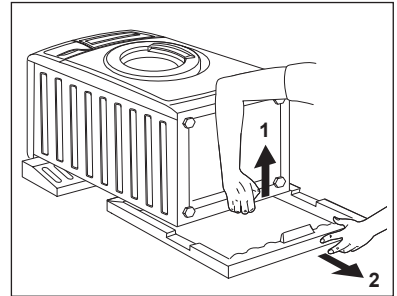

6. Tarik perkakas dalam kedudukan menegak.position.
7. Keluarkan kabel bekalan kuasa dan hos saliran dan air masuk daripada pemegang hos (A) pada bahagian belakang perkakas.

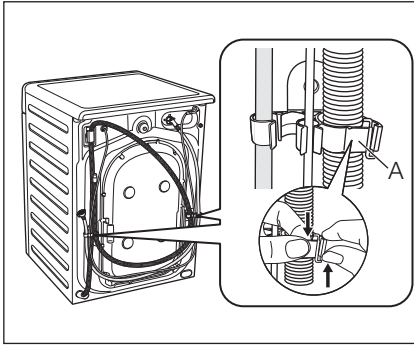

8. Longgarkan ketiga-tiga bolt.
9. Tarik keluar peruang plastik.

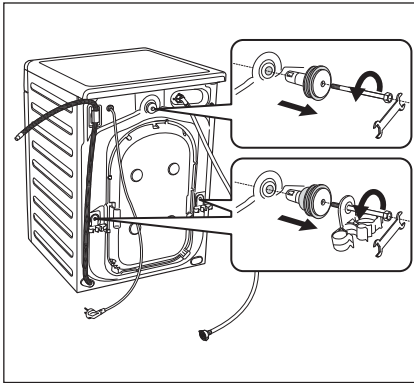

10. Letakkan penutup plastik di dalam lubang. Anda boleh menjumpai penutup ini di dalam beg manual pengguna.

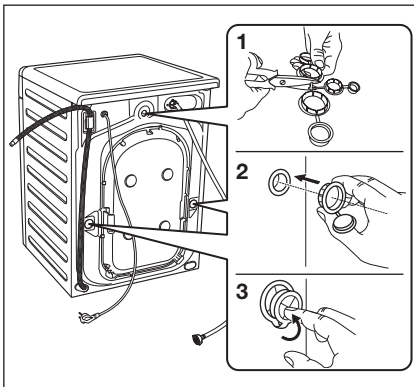

## 11.2 Kedudukan Mesin

Penting untuk mesin basuh anda didudukkan kukuh dan rata di atas lantai untuk memastikan operasi yang betul.

Perkakas tidak boleh dipasang di belakang pintu boleh dikunci, pintu gelongsor atau pintu dengan selak pada sisi bertentangan pintu mesin basuh. Gunakan paras spirit pada atas dan sisi mesin basuh untuk memeriksa paras.



Jika anda tidak mempunyai paras spirit, sebagai panduan gunakan hujung bingkai pintu, almari atau bangku untuk memastikan mesin basuh selaras.

Longgarkan atau ketatkan kaki untuk melaras ketinggian. Pelarasan yang betul paras perkakas mencegah getaran, bunyi bising dan pergerakan perkakas semasa beroperasi.

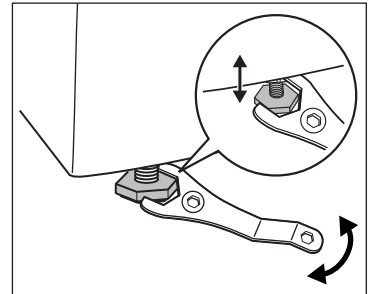



Apabila mesin basuh selaras, cuba goyangkannya dari sudut ke sudut. Jika ia bergoyang, laras semula kaki sehingga ia selaras dan tidak bergoyang.

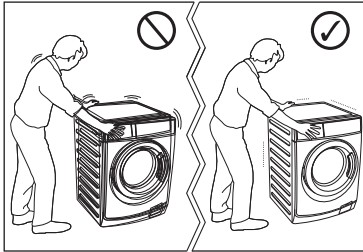

Jangan letakkan kadbad, kayu atau bahan yang sama di bawah mesin untuk meratakan lantai. Pasangkan mesin di atas lantai yang rata dan keras. Pastikan peredaran udara di sekeliling mesin tidak di ganggu oleh permaidani, dan sebagainya.

Periksa mesin supaya tidak menyentuh dinding atau almari.

### 11.3 Saliran Air Masuk

Sambungkan hos penyaliran air masuk kepada pili air dengan alur BSP 3/4".

Gunakan hos yang dibekalkan bersama mesin basuh. **JANGAN GUNAKAN HOS LAMA.** Bahagian hujung lain hos air masuk yang bersambung dengan mesin boleh dipusingkan ke arah mana sekalipun. Longgar ikatan, pusingkan hos dan ketatkan semula ikatan, pastikan tiada kebocoran air.

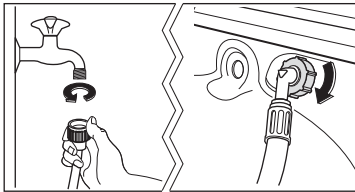

Hos air masuk tidak boleh dipanjangkan. Jika ia terlalu pendek dan anda tidak mahu mengalihkan pili air, anda perlu membeli hos baru yang lebih panjang dan yang dibuat khusus untuk kegunaan seperti ini.

### 11.4 Penyaliran Air

Hujung hos saliran boleh ditentukan kedudukannya dengan tiga cara:

- Disangkutkan pada pinggir sink menggunakan panduan hos plastik yang disediakan bersama mesin.

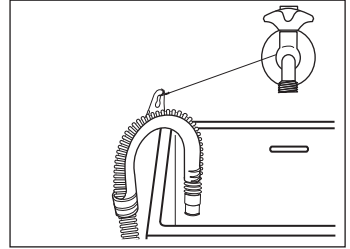

Dalam hal ini, pastikan hujung tidak disangkut apabila mesin dikosongkan. Ini boleh dilakukan dengan mengikatnya kepada paip air dengan tali atau menempatkannya pada dinding.

- Cabang ini mesti di atas perangkap supaya bengkokan sekurang-kurangnya 60 cm dari lantai.
- Terus ke dalam paip penyaliran keluar pada ketinggian tidak kurang daripada 60 cm dan tidak lebih daripada 90 cm. Hujung hos penyaliran air keluar mesti sentiasa berudara, cth. di dalam diameter paip penyaliran air keluar mesti lebih besar daripada diameter di luar hos. Hos air keluar tidak boleh terputar. Terletak di atas lantai; hanya bahagian berdekatan air keluar mesti ditinggikan.

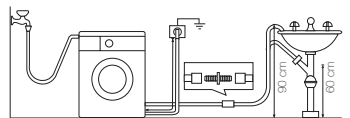

Untuk mesin berfungsi dengan betul, hos air keluar mesti disangkut dengan betul sokongan yang terletak di bahagian atas sebelah belakang perkakas.

## 11.5 Sambungan Elektrik

Mesin ini direka untuk beroperasi pada 220-240 V, fasa tunggal, 50 Hz.



**Sila semak syarat nilai bekalan kuasa diberi yang disebutkan pada Label Rating sebelum anda menyambung kepada bekalan kuasa.**

**“Bekalan kuasa yang tidak betul boleh membatalkan waranti anda.”**

Periksa sama ada bekalan elektrik rumah anda dapat menerima beban maksimum yang diperlukan (2.1 kW), dengan mengambil kira perkakas elektrik lain yang digunakan.



**AWAS!** Sambung mesin pada alur keluar soket terbumi.

Pengilang berhak menolak sebarang tanggungjawab bagi kerosakan atau kecederaan sekiranya gagal mematuhi langkah pencegahan keselamatan di atas.



Jika kabel bekalan kuasa perkakas perlu ditukar, ini perlu dilakukan oleh Pusat Servis kami.

Apabila perkakas dipasangkan, kabel bekalan kuasa mesti boleh diakses dengan mudah.

Jika perkakas ini dibekalkan kuasa dari set sambungan kord atau peranti alur keluar boleh alih, set sambungan kord atau peranti alur keluar mudah alih mesti diletakkan pada kedudukan yang tidak mengenai percikan air atau mengekang kelembapan.

## 12. KEPRIHATINAN ALAM SEKITAR

### 12.1 Bahan Pembungkusan



Bahan yang ditanda dengan simbol  boleh dikitar semula.

>PE<=polyethylene

>PS<=polystyrene

>PP<=polypropylene

Ini bermakna bahan tersebut boleh dikitar semula dengan melupuskannya dengan cara yang betul di dalam bekas pemungutan yang sesuai.

### 12.2 Mesin Lama

Gunakan tapak pelupusan yang disahkan bagi perkakas lama. Bersama-sama kita menjaga kebersihan negara!

Simbol  pada produk atau pada bungkusannya menunjukkan bahawa produk ini tidak boleh dianggap sebagai sisa buangan rumah. Sebaliknya, ia hendaklah dihantar ke pusat pungutan yang sesuai untuk mengitar semula perkakasan elektrik dan elektronik.

Dengan memastikan produk ini dilupuskan dengan betul, anda akan membantu menghindarkan berlakunya kemungkinan akibat buruk terhadap alam sekitar dan kesihatan manusia, yang boleh disebabkan jika produk ini dilupuskan tidak dengan sewajarnya.

Untuk maklumat lanjut mengenai kitar semula produk ini, sila hubungi pejabat bandar tempatan, atau khidmat pemuangan bahan buangan rumah anda atau kedai tempat anda membeli produk ini.

### 12.3 Petua Ekologi

Untuk menjimatkan air dan tenaga serta membantu melindungi alam sekitar, kami menasihatkan agar petua berikut dipatuhi:

- Kebiasaannya pakaian kotor boleh dibasuh tanpa pracuci untuk menjimatkan detergen, air dan masa (alam sekitar juga dilindungi!).
- Mesin berfungsi dengan lebih ekonomi jika ia dimuat dengan penuh.
- Dengan prarawatan mencukupi, kotoran dan kesan kotor terhad boleh ditanggalkan; cucian kemudiannya boleh dibasuh pada suhu lebih rendah.
- Sukat detergen mengikut kekasaran air, tahap kotoran dan kuantiti cucian yang mahu dicuci.

## 伊莱克斯 – 想你所想！

感谢您购买伊莱克斯电器。您选择的产品凝结了我们数十年的专业经验和创新技术。精巧时尚的外观，尽显人性化设计。因此每次使用它，您都能得到满意的效果。欢迎来到伊莱克斯的世界。

访问我们的网站：





获取使用建议、产品手册、故障解决方案以及维修服务信息：

[www.electrolux.com](http://www.electrolux.com)

## 客户关怀和服务

我们建议使用原厂备件。联系客服人员时，请确保可以提供下面的信息。您可以在产品铭牌上找到这些信息。例如型号、PNC、序列号。

 警示/安全警告信息。

 基本信息和使用提示。

 环保信息。

如有更改，恕不另行通知。

## 目录

<b>1. 安全信息</b>	
1.1 使用条件 .....	70
1.2 儿童安全 .....	70
1.3 儿童安全装置 .....	70
1.4 基本安全提示 .....	71
1.5 安装 .....	71
1.6 使用 .....	71
<b>2. 产品图解</b>	
2.1 组成部分 .....	72
2.2 产品特征 .....	73
2.3 附件 .....	73
<b>3. 控制面板</b>	
3.1 控制面板说明 .....	74
3.2 显示屏 .....	75
3.3 程序表 .....	76
3.4 程序 + 选项 .....	77
3.5 选项 .....	77
3.6 设置 .....	79
3.7 启动/暂停 (▶  ) 和添加衣物 (👚) 触控键 .....	79
<b>4. 首次使用前</b> .....	80

# 目录

<b>5. 日常使用</b>	
5.1 放入衣物	80
5.2 使用洗涤剂和洗涤助剂	81
5.3 选项设置	82
5.4 启动程序	82
5.5 中断程序	82
5.6 更改程序	82
5.7 更改选项	82
5.8 打开机门	82
5.9 程序结束	83
5.10 洗衣程序已完成，但滚筒内仍然有水	83
5.11 AUTO Off 功能	83
<b>6. 洗衣提示</b>	
6.1 对衣物进行分类	84
6.2 温度	84
6.3 放入衣物之前	84
6.4 最大衣物量	84
6.5 去除污渍	84
6.6 洗衣粉使用类型和用量	85
<b>7. 国际洗衣代码符号</b>	86
<b>8. 保养和清洁</b>	
8.1 外部清洁	87
8.2 除垢	87
8.3 每次洗衣后	87
8.4 利用“Tub Clean”程序进行保养洗涤	87
8.5 清洁投放抽屉盒	87
8.6 清洁抽屉盒的凹槽	88
8.7 清洁排水泵	88
8.8 清洁进水管过滤器	90
8.9 预防霜冻	91
<b>9. 故障诊断</b>	
9.1 可能的原因	92
9.2 紧急开门	94
<b>10. 技术参数</b>	95
<b>11. 安装</b>	
11.1 拆除包装	96
11.2 洗衣机放置	97
11.3 进水	98
11.4 排水	98
11.5 电气连接	98
<b>12. 关注环保</b>	
12.1 包装材料	99
12.2 废旧洗衣机	99
12.3 环保提示	99

# 1. ⚠️ 安全信息

## 1.1 使用条件

本机适合在家庭及类似场合使用，例如：

- 农舍
- 供酒店式公寓、度假公寓以及居住型环境的客人使用。

为了您的安全和确保正确使用洗衣机，在安装和首次使用本机前，请仔细阅读本用户手册，包括相关的提示和警告。

为避免不必要的错误和意外，务必要确保本机的所有使用者都充分熟悉其各项操作特性和安全特性。

请妥善保留本说明书，搬运或出售本机时，应确保随机附带本说明书，以便机器使用寿命内的每位使用者都能适当了解机器的使用方法和安全须知。

## 1.2 儿童安全

- 除非有适当的监督指导，否则本洗衣机不供儿童或体弱多病者使用。
- 应对儿童加以照看，确保他们不会玩耍洗衣机。
- 包装材料组件（如塑料薄膜、聚苯乙烯泡沫）可能危及儿童安全 - 存在窒息危险！请妥善将其放在儿童无法触及的地方。
- 将所有洗涤剂放在儿童无法触及的安全地方。
- 确保儿童或宠物不会爬入滚筒。
- 本机器提供儿童锁保护功能（），以避免儿童误操作控制面板。（参考第 79 页）。

## 1.3 儿童安全装置

启用此装置时，机门无法关闭。这样可以防止儿童或宠物锁在洗衣机内。

- 要启用此装置，请顺时针旋转（无需按动）机门内侧的按钮，直到按钮上的凹槽转至水平位置。如有必要，可借助硬币。
- 要禁用此装置以便可以关闭机门，请逆时针旋转该按钮，直到按钮上的凹槽转至垂直位置。

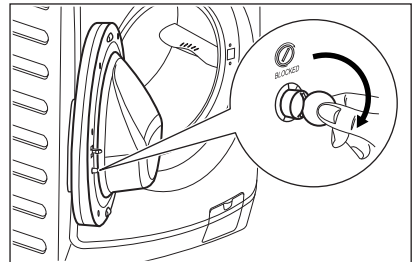

## 1.4 基本安全提示

- 以任何方式更改产品规格或试图改装本产品的做法都是危险的。
- 高温洗衣程序运行期间，机门玻璃可能会很热。切勿触摸！
- 确保宠物不会爬入滚筒内。为避免这种情况的发生，请在使用本机前对滚筒内进行检查。
- 任何诸如硬币、别针、钉子、螺丝钉、石块等物品或任何其他坚硬、锋利材料都可能造成大面积损坏，因此不得放入洗衣机中。
- 袜子、蕾丝带、可洗皮带等小件物品应放在洗衣袋或枕套内洗涤，因为这些小物件可能会落入洗衣桶与内滚筒之间。
- 仅使用建议用量的衣物柔顺剂和洗涤剂。如果用量过大，可能会损伤衣物或洗衣机。请遵循制造商的用量建议。
- 不要使用洗衣机洗涤带坚硬部分的物品、未摺边或开线的衣物。
- 每次使用、清洁以及保养本机之后，始终要拔下电源插头并关闭水龙头。
- 本机不适合身体残障、感官或精神功能减退以及缺乏相关经验和知识的人员（包括儿童）使用，除非有负责其安全的人员对其使用本机给予监督或指导。
- 在任何情况下，不应尝试自行维修洗衣机。由缺乏相关经验的人员维修洗衣机可能会导致人身伤害或设备严重故障。请联系您当地的维修服务center。应始终坚持使用原厂备件。

## 1.5 安装

- 本机非常沉重。搬动时应多加小心。
- 拆除本机的包装时，请检查洗衣机是否有任何损坏。如有任何疑问，请勿使用，并联系维修服务中心。

- 使用洗衣机之前，必须拆除所有包装材料 and 运输螺栓。否则，本产品和其他财物可能会严重受损。请参阅本用户手册的相关章节。
- 洗衣机安装完毕后，检查并确认进水管和排水管没有被洗衣机压住，且工作台面不挤压电源线。
- 如果将本机摆放在铺有地毯的地板上，请适当调整底脚，以便空气能够自由流通。
- 安装完毕后，始终要确保水管及水管连接处没有漏水现象。
- 安装本机所需的水管敷设工作应由合格的水管工人完成。
- 安装本机所需的电气工作应由合格的电工完成。



可能触电！如果连接洗衣机的插座不是接地插座。请勿触摸湿衣。

## 1.6 使用

- 本机专为家庭使用而设计。除了专门设计的用途外，不得将本机用于其他用途。
- 仅洗涤适宜机洗的衣物。请遵循每件衣服标签上的洗涤说明。
- 不得在本机内放入过量衣物。请参阅本用户手册的相关章节。
- 开始洗衣前，确保已掏空所有衣袋、扣紧纽扣并拉好拉链。避免洗涤有磨损或破损的物品，并在洗衣前处理颜料、油墨、锈迹及草叶等污渍。带钢圈的胸罩不得机洗。
- 接触过挥发性石油产品的衣物不得机洗。如果使用了挥发性的清洗液，那么一定要注意确保先除去衣物上的清洗液，然后再放入洗衣机中。
- 从电源插座上拔下插头时，切勿拽拉电源线；始终应用手握住插头。
- 如果电源线、控制面板、工作台面或底座发生损坏而露出洗衣机内部，请勿使用洗衣机。

## 2. 产品图解

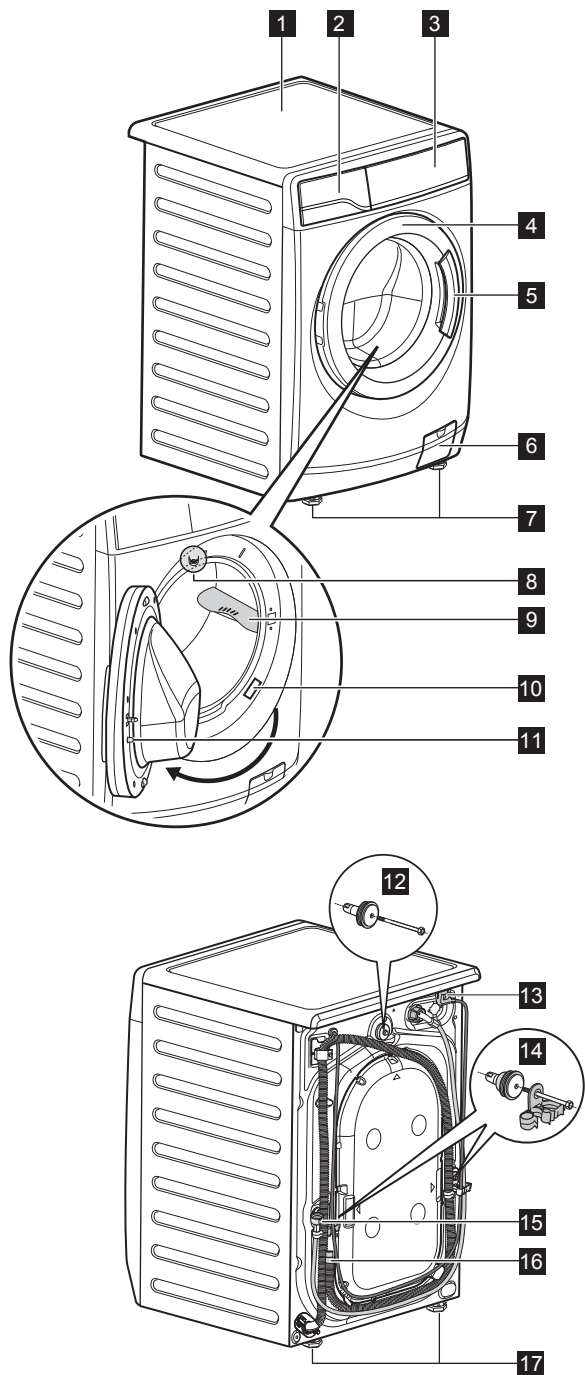

### 2.1 组成部分

- 1** 工作台面
- 2** 洗涤剂/柔顺剂投放格  
参考第 81 页。
- 3** 控制面板
- 4** 洗衣机门
- 5** 机门拉手
- 6** 排水泵过滤器

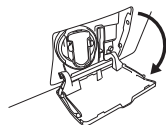

参考第 88 页。

- 7** 水平调整脚（前  
端）
- 8** 洗衣桶照明
- 9** 滚筒叶片升降器
- 10** 铭牌
- 11** 机门锁钮

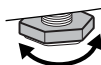

- 12** 运输螺栓
- 13** 电源线
- 14** 运输螺栓 + 水管夹
- 15** 进水软管
- 16** 排水软管
- 17** 水平调整脚（后  
端）



参考第 70 页。

- 12** 运输螺栓
- 13** 电源线
- 14** 运输螺栓 + 水管夹
- 15** 进水软管
- 16** 排水软管
- 17** 水平调整脚（后  
端）

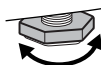

小心！

在使用洗衣机前，必须拆除所有运输（3 组成部分）。



## 2.2 产品特征

### • Load Sensor (重量感应器)

本机带有“衣物量感应装置”，可显示洗衣机内加入的衣物量和针对选定洗衣程序的建议最大衣物量。

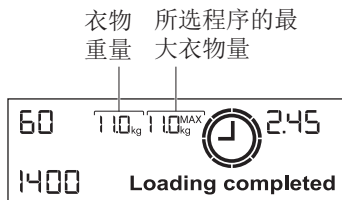

- 当达到选定程序的衣物量上限时，显示屏将显示“Loading completed”（添加衣物完成）。
- 在显示屏上，衣物的重量按 0.5 千克递增。
- 该重量是一般指示，会随衣物类型的不同而变化。
- 如果放入的衣物超过所选程序的重量上限，上限数字会闪烁并发出“哔，哔”声。

**i** 机门打开时，显示屏将显示这些标志。



**i** 显示屏上显示的只是衣物的大约重量。

**i** 为使重量感应器能正常工作，请先在滚筒内装入衣物，然后再启动洗衣机并设定洗衣程序。

### • 洗涤剂用量设置

文字显示栏还会在添加衣物后关闭机门时指示洗涤剂的用量。

默认情况下，洗涤剂用量的指示值用百分比表示。100% 表示洗涤剂抽屉盒的  投放格内可放入的最大洗涤剂用量（数量按产品制造商的说明）。

您可以同时按住  和  并保持几秒钟，将该指示值的单位设置为 ml，以使数值更精确。

- 文字显示栏中将显示“**Set dosage detergent**”（设定洗涤剂用量）消息。
- 反复按  将洗涤剂用量设定为包装上的制造商建议最大用量，即相当于 100% 的量。
- 有关洗涤剂最大用量的信息，请参见包装上制造商关于洗涤剂的建议。

**i** 您可以设置 0 毫升至 330 毫升的 100% 等值。

- 按  进行确认。

## 2.3 附件

### • 塑料盖



用于在卸下运输螺栓后堵住机箱背部的孔口。

### • 塑料软管导向套



用于将排水管连接在水槽边缘。

## 3. 控制面板

### 3.1 控制面板说明

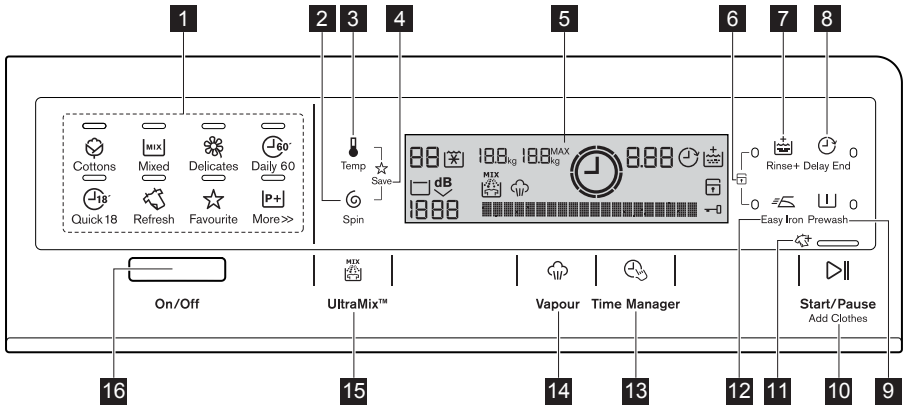

**1** 程序触控按钮

**2** 脱水选择触控按钮

**3** 温度触控按钮

**4** 常用程序

**5** 显示屏

**6** 儿童安全锁功能（参见第 79 页）

**7** 加强漂洗触控按钮

**8** 预约触控按钮

**9** 预洗触控按钮

**10** 启动/暂停 和 添加衣物触控键

**11** 添加衣物功能图示

**12** 防皱易熨触控按钮

**13** 时间管理触控键

**14** 蒸汽触控按钮

**15** UltraMix 超强混合触控键

**16** 电源开关按钮

### 3.2 显示屏

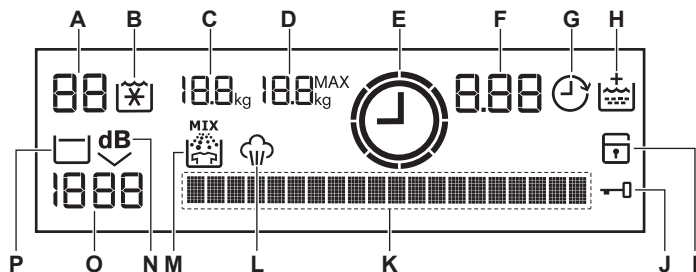



- A) 洗衣温度
- B) 温水图标
- C) 衣物重量
- D) 所选程序的最大衣物量
- E) Time manager 图标
- F) 洗衣循环时间/预约时间
- G) 预约图标
- H) 加强漂洗图标
- I) 儿童安全锁图标
- J) 门锁图标

- K) 文字显示栏
- L) 蒸汽图标
- M) Ultramix 图标
- N) 超静音图标
- O) 脱水速度
- P) 延迟脱水图标

**i** 机门打开时，显示屏将显示“C”和“D”标志。

### 3.3 程序表

程序; 温度	最大衣物量 (晾衣服); 脱水速度	衣物类型和脏污程度
 <b>Cottons</b> (棉质织物);  2) 至 90 °C	11 kg; 1400 rpm	白色和彩色棉质织物。(根据土壤水平调整洗涤时间。参见第 78 页上的“时间管理”表。)
 <b>Mixed</b> (混合织物);  至 60 °C	4 kg; 1200 rpm	化纤或混合面料织物。(根据土壤水平调整洗涤时间。参见第 78 页上的“时间管理”表。)
 <b>Delicates</b> (纤幼织物);  至 40 °C	4 kg; 1200 rpm	的精致织物, 如丙烯酸织物、纤维胶、聚酯类衣物。(根据土壤水平调整洗涤时间。参见第 78 页上的“时间管理”表。)
 <b>Daily 60</b> (日常 60); 30 °C 至 60 °C	5.5 kg; 1400 rpm	彩色棉, 如男女衬衫、毛巾和内衣, 一般脏污程度。
 <b>Quick 18</b> (分钟快洗); 30 °C	1.5 kg; 800 rpm	轻微肮脏合成纤维或混合型面料。
 <b>Refresh</b> (清新)	1.5 kg; 衣物在蒸汽中翻转。	此过程可除皱除味, 使衣物清新。  这个周期无需添加洗涤剂。
 <b>Favourite</b> (我最喜欢的)	-	要调出“我最喜欢的”洗涤程序。
<b>IP+</b> <b>More</b> (更多) >> (按下此方案触摸垫多次找更多的程序如下面列表。)		
- <b>Baby Care</b> (婴儿);  至 40 °C	4 kg; 1200 rpm	脏污程度一般的棉质婴儿衣物和精致针织衣物。
- <b>Sports</b> (运动); 30 °C	2.5 kg; 800 rpm	适用于清洗精致混合面料衣物的轻柔程序。
- <b>Wool</b> (羊毛);  至 40 °C	2 kg; 1200 rpm	为带有“纯新羊毛、不缩水、可机洗”标签的羊毛衣物专门测试的洗衣程序。
- <b>Energy Saver</b> (节能洗); 40 °C 至 60 °C 1)	11 kg; 1400 rpm	脏污程度一般的白色和不褪色棉质衣物。设定此程序可达到良好洗涤效果并降低能耗。洗衣程序的时间将延长。
- <b>Spin</b> (脱水)	11 kg; 1400 rpm	对衣物脱水并排空滚筒中的水。
- <b>Rinse + Spin</b> (漂洗 + 脱水)	11 kg; 1400 rpm	漂洗衣物并进行脱水。
- <b>Bedding</b> (床上用品);  至 60 °C	3 kg; 800 rpm	单件化纤毛毯、被罩和床单等用品的专用程序。(根据土壤水平调整洗涤时间。参见第 78 页上的“时间管理”表。)
- <b>Heavy Duty</b> (强力清洗); 40 °C 至 90 °C	11 kg; 1400 rpm	适用于非常肮脏的棉质衣物。
- <b>Tub Clean</b> (桶清洗);	- kg; - rpm	适用于清洗洗衣桶。

1) 满负荷洗涤脏污程度一般的棉质衣物时, 建议使用贴有节能节水能效标签的节能洗程序, 并选择 60°C 的温度选项。

2) 符号“”代表冷水洗涤

### 3.4 程序 + 选项

程序 / 选项	脱水								
	不脱水	延迟脱水	超静音						
Cottons	✓	✓	✓	✓	✓	✓	✓	✓	✓
Mixed	✓	✓	✓	✓	✓	✓	✓	✓	✓
Delicates	✓	✓	✓	✓	✓		✓	✓	✓
Daily 60	✓	✓		✓	✓				✓
Quick 18	✓	✓			✓				X
Vapour Refresh					✓				✓
Baby Care	✓	✓	✓	✓	✓		✓		X
Sports	✓				✓				X
Wool	✓	✓	✓		✓				X
Energy Saver	✓	✓		✓	✓		✓	✓	X
Spin	✓				✓				
Rinse + Spin	✓	✓			✓				
Bedding	✓				✓			✓	✓
Heavy Duty	✓	✓	✓	✓	✓				X
Tub Clean					✓				X

1) 蒸汽选项仅可在 40 - 90 °C 温度时组合使用。

✓ 可以选择和禁用选项。

X 不能禁用选项。

### 3.5 选项

#### 温度触控按钮 ( )

如果希望使用不同于洗衣机建议的温度洗涤衣物，请多次按该按钮升高或降低洗衣温度。

#### 脱水选择触控按钮 ( )

如果希望使用不同于洗衣机建议的转速为衣物脱水，请反复按此触控按钮加快或减慢脱水转速。

#### • 不脱水 No Spin ( )

“不脱水”选项将取消所有脱水阶段并增加漂洗次数。

#### • 超静音 Extra Silent ( )

选择此选项时，洗衣机将不排掉最后一次漂洗时的水，以免衣物出现褶皱。此时将停止所有脱水阶段。

该洗衣程序非常安静，可选择在夜间或其他适宜的时间段内使用。

机门将保持锁定并且滚筒内有水。要继续洗衣程序，必须按 (启动/暂停)。

#### • 延迟脱水 Rinse Hold ( )

选择此选项时，将不排空最后一次漂洗时的水，并且滚筒会定时旋转以防止衣物褶皱。

机门仍将保持锁定，以提醒您必须排空滚筒内的水。

机门将保持锁定并且滚筒内有水。要继续洗衣程序，必须按 (启动/暂停)。

#### 加强漂洗触控按钮 ( )

此选项建议用于对洗涤剂过敏的人群以及水质很软的地区。选择该选项，为该程序添加 2 次漂洗。此选项的标志将亮起。

## 预约 触控按钮 (🕒)

开始该程序之前，该选项可让您将洗涤程序的结束时间从至少 1 小时界定为至多 19 小时。

**i** 如果程序持续时间大于 3 小时（最小值），则“延迟结束”选项的起始值为 4 小时。

按下“延迟结束”触摸板，选择您想要的结束时间。显示器显示时数，触摸板上面的指示灯处于亮起状态。

**i** 选择洗涤程序之后，必须选择该选项，然后再按下“开始/暂停”触摸板。

例如，如果您所选程序的持续时间为 3.20 小时，可将“延迟结束”时间定义为 6 小时。这意味着您的洗涤程序将在 6 小时内结束。（请参见下图）

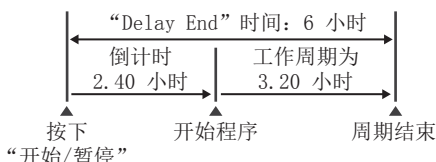

选择“延迟结束”时间后，按下“开始/暂停”触摸板，开始该程序。然后洗衣机将进入倒计时并在显示器上每隔数小时就更新时间一次，直到它到达洗涤周期的起点。如果开始该程序之后您想修改或取消“延迟结束”选项，请执行以下步骤：

- 按下“开始/暂停”触摸板，将洗衣机设置为“暂停”；
- 反复按下“预约剩余时间”触控键，直到显示屏上显示的预约剩余时间为“0”，即取消选择此选项；
- 按下“开始/暂停”，开始该程序。

## 防皱易熨触控按钮 (👉)

选择此选项时，衣物将经过轻柔的洗涤及脱水过程，以防止起皱。这样可使衣物更易于熨烫。

此选项的标志将亮起。

## 预洗触控按钮 (👉)

如果希望在开始主洗之前预洗衣物，请选择此选项。此选项适合洗涤脏污程度严重的衣物。此选项的标志将亮起。

当设定此功能时，请将洗涤剂放入“👉”投放格中。

此功能将延长程序的持续时间。

## 时间管理 (🕒)

使用此选项可缩短洗衣时间。反复按此按钮可缩短或返回默认的洗衣时间。根据所挑选的洗涤时间，此项功能将调节冲洗的次数。使用下表作为指南。

肮脏级别	轻度	中等	正常	沉重
洗净级别				

## 蒸汽洗涤触控按钮 (👉)

选择此选项可以在洗衣周期内添加时长约为30分钟的蒸汽洗涤程序。蒸汽有助于打开衣料纤维间的空隙，使洗涤剂可以祛除顽固污渍。此选项的标志将亮起。

### 注意：

- 在蒸汽洗涤程序期间，蒸汽不一定在滚筒内清晰可见。蒸汽将在滚筒下方生成，然后自然上升并渗入衣物中。
- 整个蒸汽洗涤期间可能都不会出现蒸汽。
- 一半衣物量时，蒸汽洗涤功能效果更佳。
- 蒸汽程序结束时，衣物将变得更温暖、更柔软并从滚筒中脱离。

**i** 如果选择了蒸汽洗涤选项，漂洗温度将会升高。

在蒸汽洗涤期间，洗衣机的排水管可能会排出蒸汽，这属于正常现象，不会引起报警。

## UltraMix 超强混合 (👉)

当您选择这一选项，清洁剂会在一个“预混技术”盒中混合和溶解在水中。这可以在将清洁剂洒在衣物上之前，充分激活其清洁力。

### 注意:

- 建议选择这一选项时使用温水，温水可以更有效地溶解清洁剂，达到更好的效果。
- 由于 UltraMix () 功能增强洗衣粉的溶解，相比普通洗衣机。建议仅使用相当于普通洗衣机的 50% 的洗衣粉。如果泡沫仍然过多，则表示洗衣粉用量仍然过多，此时请继续减少用量。过量洗衣粉会导致衣服褪色，泡沫过多，漂洗不干净。

## 3.6 设置

### 常用程序 (☆)

用户可存储经常使用的洗涤程序（如棉质布料，60° C，1200rpm 预洗和额外漂洗）。

请按照如下步骤，设置或重新设置您的自定义洗涤程序，并存储：

1. 把洗衣机模式设置为“待机”模式。
2. 选择您要的洗涤程序。
3. 如需保存常用程序，同时按下“Temp”和“Spin”触控键，直到显示屏上显示“Program Saved”（已保存程序）。

要调出“我最喜欢的”洗涤程序，请按下“我最喜欢的☆”按钮。

洗衣机的屏幕上会显示已加载“我最喜欢的”洗涤程序。



用户仅能在洗衣机处于程序选择模式时调出“我最喜欢的”洗涤程序处于程序选择模式。否则，触碰“我最喜欢的”按钮将不会产生任何作用。

### 儿童安全锁功能 ()



本机提供儿童安全锁功能，可以在洗衣机无人看管时保持机门关闭，从而不必担心洗衣机对儿童造成伤害或本身发生损坏。

 按下“启动/暂停”后触摸板的设置此选项。

设定儿童安全锁选项：

- 要启用此功能，请同时按“Rinse + ()”和“Easy Iron ()”触控按钮，直到显示屏上显示“”符号。

 在触摸板被锁定（除了“开/关”（On/Off）按钮）。



- 要停用此功能，请同时按“Rinse + ()”和“Easy Iron ()”触控按钮，直到“”符号熄灭。

 即使已切断洗衣机电源，此功能仍会保持启用状态。

## 启用/禁用“洗涤结束蜂鸣模式”

此模式允许您启用或禁用洗涤结束时的蜂鸣声。例如您需要在睡觉时进行洗涤，希望禁用该蜂鸣声，从而在大约 1 小时的洗涤结束后，洗衣机不会发出声音打扰您的休息。

 此设置无法禁用所有错误蜂鸣声，例如危险故障。

如需禁用蜂鸣声，同时按住“Easy Iron ()”和“Prewash ()”触控键 3 秒钟，并听到“哔，哔”声。

如需恢复默认设置，同时按住这两个触控键 3 秒钟，并听到“哔”声。

## 3.7 启动/暂停 () 和添加衣物 () 触控键

此触控键有两个功能：

- **启动/暂停** ()

选定所需程序和选项后，按下此触控键启动洗衣机。启动/暂停指示灯将停止闪烁并常亮，直到水位超过机门的下缘，这时，指示灯会熄灭。如果您已选择“预约剩余时间”选项，倒计时将开始并显示在显示屏上。

如需中断正在运行的程序，按下此触控键即可暂停洗衣机，启动/暂停指示灯闪烁。

如需从程序被中断的时候重新启动程序，再次按下此触控键，启动/暂停指示灯将停止闪烁。

### • 添加衣物 (🔄)

**i** 只能在“启动/暂停”灯亮起的时候添加衣物。

程序正在运行时，可按以下步骤添加衣物：

1. 按下“启动/暂停”触控键暂停程序。
2. 等洗衣机完全停止后打开机门。

3. 添放衣物，并关上机门。

4. 再次按下“启动/暂停”触控键恢复程序。

## 4. 首次使用前

**i** 在安装过程中还是第一次使用前，你可以在机器观察到了一些水。这是留在机器在出厂全功能测试后，保证了机器的剩余的水提供给客户完美的工作秩序，是无需担心。

1. 确保电气和水路连接符合安装说明。
2. 向洗涤剂投放格内加入 2 升水用于主洗阶段。此操作将启动排水系统。

3. 洗衣机内不添加衣物，选择棉质织物程序并将温度设定为 90 °C，以去除制造过程中内筒和外筒上的残留物，然后启动洗衣机。

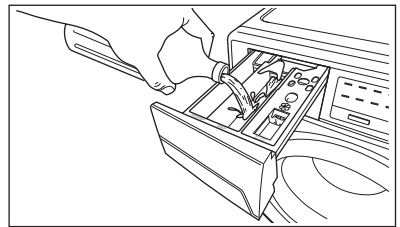

## 5. 日常使用

### 5.1 放入衣物

1. 打开水龙头。
2. 将电源插头插入电源插座。
3. 按下电源开关启动洗衣机。触按其中一个程序图标，选择需要的洗衣程序。

**i** 为使重量感应器能正常工作，请先在滚筒内装入衣物，然后再启动洗衣机并设定洗衣程序。

4. 小心地向外拉动机门拉手，打开机门。  
检查并取出可能落入折边处的物件（如果有的话）。

5. 将衣物放入滚筒内，每次放入一件，并尽量将衣物抖开。

6. 关闭机门。

**!** 小心

确保门封和机门之间没有夹住任何衣物。

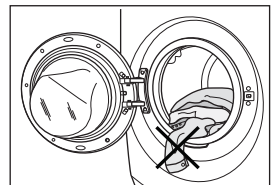



## 5.2 使用洗涤剂和洗涤助剂

**i** 在使用洗衣粉之前请阅读 85 页 洗衣粉使用类型和用量。

### 1. 洗涤剂投放抽屉盒

洗涤剂投放抽屉盒分为三个投放格。

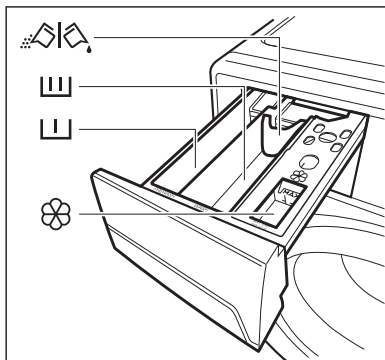

#### • 主洗投放格

此投放格用于投放所有洗衣程序使用的洗涤剂。

#### • 预洗投放格

此投放格仅用于在选择预洗程序时投放洗涤剂。

#### • 柔顺剂投放格

此投放格用于投放衣物柔顺剂和上浆剂。

#### 洗涤剂挡板

用于投放粉状或液体洗涤剂的挡板。



- 位置向下：适合投放液体洗涤剂。

- 位置向上：适合投放粉状洗涤剂（出厂设置）。

### **i** 使用液体洗涤剂时：

- 请勿使用胶状或粘稠的液体洗涤剂。
- 投放的液体洗涤剂不得超过最大液位线。
- 请勿设定预洗阶段。
- 请勿设定预约功能。

### 2. 量取适量的洗涤剂和衣物柔顺剂：

- 拉出洗涤剂投放抽屉盒，直到拉不动为止。
- 视需要量取适量洗涤剂，倒入主洗投放格中。

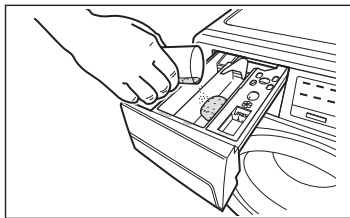

- 如果要运行“预洗”阶段，请将洗涤剂倒入标有 的投放格中。
- 如果需要，可将衣物柔顺剂倒入标有 的投放格中。

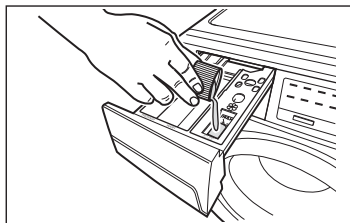

**i** 用量不得超过抽屉盒的最大标记“MAX”

建议使用浓缩织物柔软剂时先用稀释柔软剂。

- 轻轻关上抽屉盒。

**i** 在洗涤程序完成后，洗涤剂、织物柔软剂和水可能会沉积在洗涤剂料盒里。建议经常清洗洗涤剂料盒，以清除沉积物。

### 5.3 选项设置

1. 如果希望使用不同于洗衣机建议的脱水速度和温度洗涤衣物，请反复按脱水“⊙”和温度“⚡”触控按钮更改脱水速度和温度。

如果希望使用特殊功能洗涤衣物，根据需要按相应的选项触控按钮。

#### 注释

- 根据选定的洗衣程序的不同，可以组合使用各种不同的功能。
- 如果选择与预设洗涤程序不兼容的选项，“Not Available”消息将闪烁，并发出哔哔声。

2. 如果希望缩短洗衣时间，反复按“Time Manager (🕒)”触控按钮缩短洗衣时间。参见第 78 页上的 Time Manager (🕒) 指南。

如果希望预约洗衣程序，按预约触控按钮  选择洗衣机的预约时间。

### 5.4 启动程序 (▶||)

要启动程序，请按启动/暂停 (▶||) 触控按钮，对应的指示灯将停止闪烁，显示屏上将显示默认的程序持续时间。

#### 注释

- 如果在程序正在运行时按下任何触控键，显示屏将显示“Not Available”消息，并发出哔哔声。  
(启动/暂停触控键和电源开/关按钮除外)

#### 程序启动约 15 分钟后：

- 洗衣机将根据衣物类型和衣物量自动调整选定的程序持续时间。
- 显示屏将显示调整后的程序持续时间。

### 5.5 中断程序

- 要暂停程序，请按启动/暂停按钮。对应的标志将开始闪烁。
- 再次按启动/暂停触控按钮。程序将继续运行。

### 5.6 更改程序

要更改正在运行的程序，只能关闭洗衣机电源。

- 按电源开/关按钮取消程序并关闭洗衣机。
- 再次按电源开/关按钮启动洗衣机。

此时即可设定新的洗衣程序。



 在此期间，洗衣机不会排水。

### 5.7 更改选项

程序启动后，只能更改部分选项。

1. 按启动/暂停触控按钮。对应的标志将开始闪烁。
2. 更改选项。
3. 再次按启动/暂停触控按钮。程序将继续运行。

### 5.8 打开机门

洗衣程序或预约功能运行时，机门将保持紧锁状态，同时显示屏显示“ ”标志。首先按启动/暂停触控按钮，将洗衣机设为“PAUSE”（暂停）状态。待门锁标志“ ”熄灭后，即可将机门打开。

如果门锁标志“ ”没有消失，表示洗衣机已经在加热，并且水位高出机门底边，或者滚筒正在转动。这种情况下，机门将无法打开。如果您需要打开它，你必须沥干水开门。（阅读段落“要进行排水”）

 如果是紧急情况下需要立即打开机门。请阅读“紧急开门”第 94 页上。

## 5.9 程序结束

- 洗衣机将自动停止运行。
- 提示声将响起。
- 显示屏将显示“0”。
- 启动/暂停触控按钮的标志将熄灭。
- 门锁标志“ ”将熄灭。
- 将衣物从洗衣机内取出。确保滚筒已完全清空。
- 保持机门微开，以免滋生霉菌和产生异味。
- 关闭水龙头。

 在洗涤程序结束时，洗涤剩余时间可突然从 7 分钟或更短时间缩短至 0 分钟，这是因为在自动感应衣服容量时所预估的总洗涤时间过长。在某些情况下（负荷完美平衡），在自动感应衣服容量之后，洗涤时间可能会短于预估时间。这是机器的正常工作，因此不必担心，因其并不会影响洗涤效果。

## 5.10 洗衣程序已完成，但滚筒内仍然有水

（使用选项“Rinse Hold”或“Extra Silent”）

- 滚筒将定时转动，以防止衣物起皱。
- 该指标“Start/Pause”闪烁，提醒您沥干水。
- 门锁标志“ ”将亮起。机门保持紧锁状态。

您必须将水排空才能打开机门。

**要进行排水：**

1. 按下“Start/Pause  ”触摸板。  
洗衣机排水并按照所选程序的最大脱水速度旋转。  
或者，按“Start/Pause”触摸板之前，您可以按下“Spin”触摸板改变旋转速度。如果您只想排水，则可以选择“No Spin”，然后按下“Start/Pause”触摸板。洗衣机将排水和旋转。

2. 程序结束时，门锁标志“ ”将熄灭，这时可以打开机门。
3. 按下“On/Off”按钮关闭设备。

 **注意：**

大约 18 小时后，如果您不按“开始/暂停”触摸板，洗衣机将自动排水和旋转（除“Wool”程序外）。

## 5.11 AUTO Off 功能

AUTO Off 功能根据以下情况自动解除机器操作以减少耗电量：

- 当您还没按下“Start/Pause”按钮之前也没按下任何按钮约五分钟。

 按下“On/Off”按钮以重新操作机器。

- 当洗涤结束五分钟之后。
  - 按下“On/Off”按钮以重新操作机器。显示屏显示最后一组程序结束。
  - 触摸任何触摸板，显示屏显示最后一个安装程序和选项。
  - 再次触摸触控板的程序，要设置一个新的周期。

## 6. 洗衣提示

### 6.1 对衣物进行分类

请遵循每件服装标签上的洗衣代码符号以及制造商的洗涤说明。对衣物进行以下分类：白色织物、彩色织物、化纤织物、纤幼织物、羊毛织物。

### 6.2 温度

90°C	脏污程度一般的白色棉麻类织物（如茶巾、毛巾、桌布、床单等）。
60°C 50°C	脏污程度一般且不褪色的棉麻或化纤类衣物（如衬衫、睡袍、睡衣等）或者脏污程度较轻的白色棉质衣物（如内衣裤）。
40°C 30°C Cold	精致织物（如网眼窗帘），混合面料衣物（包括化纤衣物）以及带“纯新羊毛、可机洗、不缩水”标签的羊毛衣物。

### 6.3 放入衣物之前

- 确保衣物内没有留下任何金属物件（如发夹、别针、饰针）。
- 扣好枕套、拉紧拉链，扣合钩扣和按扣。系好所有腰带或长带子。
- 在洗衣袋中洗涤胸罩、连裤袜和其他精细织物，您可以在超市购买洗衣袋。

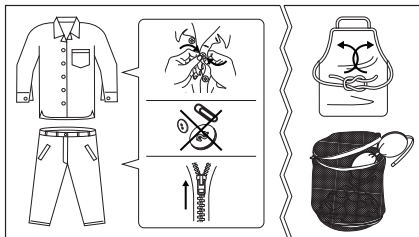

- 请确保棉纤收集器与棉质衣物分开洗涤。
- 切勿将白色与彩色衣物一同洗涤。白色衣物可能会在洗衣过程丧失洁白度。

- 新的彩色衣物在初次洗涤时可能会掉色，因此第一次应单独分开洗涤。
- 开始洗衣之前，先祛除顽固污渍。
- 可用专用洗涤剂或膏状洗涤剂擦洗特别脏污的部位。应小心谨慎地处理窗帘。可取下钩子或者将它们系好后放入洗衣袋或洗衣网内。

### 6.4 最大衣物量

程序表部分给出了建议的最大洗衣量。基本原则如下：

棉麻织物：	装满滚筒，但不能塞得太满；
化纤织物：	不超过滚筒容量的一半；
精致织物和羊毛织物：	不超过滚筒容量的三分之一。

按最大衣物量洗涤可以使水和能源得到高效利用。对于脏污程度严重的衣物，应适当减少衣物量。

### 6.5 去除污渍

只靠水和洗涤剂可能无法去除顽固污渍。因此在开始洗衣前，建议预先对顽固污渍进行处理。

**血渍：**使用冷水处理新沾染的血渍。对于干掉的血渍，先将衣物放入溶有专用洗涤剂的水中浸泡一晚，然后再用肥皂和水搓洗。

**油性颜料：**先用轻油去污剂浸湿，再将衣物平放在软布上，然后轻轻擦拭污渍；进行多次处理。

**干燥的油污：**先用松节油浸湿，再将衣物平放在柔软表面，然后用指尖和棉布轻轻擦拭污渍。

**锈迹：**在热水中溶解草酸，或者在冷水中使用除锈产品。处理早先出现的锈迹时应多加小心，因为此时衣物的纤维素结构已被破坏，所以比较容易破洞。

**霉斑：**用漂白剂处理，然后充分漂洗（仅限白色和不褪色衣物）。

**草渍：**用肥皂轻轻擦洗，然后用漂白剂处理（仅限白色和不褪色衣物）。

**圆珠笔迹和胶水：**先用丙酮溶液(\*)浸湿，再将衣物平放在软布上，然后轻轻擦拭污渍。

**唇膏：**按上述方法用丙酮溶液(\*)浸湿，然后用甲基化酒精进行处理。用漂白剂去除白色织物上残留的任何痕迹。

**红酒：**在溶有洗涤剂的水中浸泡，漂洗后用醋酸或柠檬酸进行处理，然后漂洗干净。用漂白剂处理所有残留痕迹。

**墨水：**根据墨水类型的不同，先用丙酮溶液(\*)浸泡衣物，然后再用醋酸浸泡；用漂白剂处理白色衣物上残留的任何痕迹，然后彻底漂洗干净。

**焦油污渍：**先用去污剂、甲基化酒精或轻质汽油进行处理，然后用膏状洗涤剂擦洗。

(\*) 不要对人造丝织物使用丙酮。

## 6.6 洗衣粉使用类型和用量

本洗衣机推荐使用低泡洗衣粉以避免泡沫过多，影响洗涤性能和对机器造成伤害。专门为滚筒洗衣机设计的低泡洗衣粉常常标示有“Low Suds”，“Super Low Suds”。比如洗衣粉“Spin”，“TOP”。不要使用错误类型的洗衣粉。

比如不要在本机器使用波轮式，手洗洗衣粉和肥皂粉。错误的洗衣粉类型可能导致过量的泡沫，超长的洗涤时间，较低的脱水转速，比较差的漂洗结果和导致电机过载。

### 洗衣粉用量

正确的洗衣粉的用量不仅可以保证洗涤性能，还可以避免浪费和保护环境。虽然洗衣粉最后能被生物降解，但洗衣粉中含有大量导致生态不平衡的物质。

#### 选择洗衣粉用量的根据

- 织物类型，比如精细，羊毛，纯棉等等。
- 衣服的颜色
- 衣服的脏污程度
- 衣服量的多少
- 洗涤温度
- 水的硬度

水的硬度分为不同的硬度等级。

水的硬度可以从供水公司或本地的相关水务管理部门获得。

建议初次使用时根据洗衣粉制造商的说明，然后根据洗涤结果来调整下一次的洗衣粉用量。

**洗衣粉用少了会导致：**

- 衣服还有残留污垢

**洗衣粉用多了会导致：**

- 泡沫过多
- 漂洗结果不好
- 洗涤效果不佳

**在下面的情况下需要减少洗衣粉用量：**

- 洗涤少量衣服
- 衣服不太脏
- 洗涤过程中泡沫过多

## 7. 国际洗衣代码符号

**i** 织物标签上会带有以下符号，以帮助您选择最佳的衣物护理方式。

 强力洗   轻柔洗	 最高洗涤 温度 95 °C	 最高洗涤 温度 60 °C	 最高洗涤 温度 40 °C	 最高洗涤 温度 30 °C	 手洗	 不可洗
 漂白	 冷水漂白			 不可漂白		
 熨烫	 高温熨烫最高 200 °C	 中温熨烫最高 150 °C	 低温熨烫最高 110 °C	 不可熨烫		
 干洗	 可用所有溶剂 进行干洗	 可用四氯乙烯、 汽油、纯酒精、 R 111 和 R 113 进行干洗	 可用汽油、纯酒 精和 R 113 进行 干洗	 不可干洗		
 干衣	 平摊干燥	 悬挂干燥	 置于衣架上	 高温   低温 滚筒干燥	 不可滚筒干燥	



**警告！**  
在进行任何清理或维护工作之前，必须断开洗衣机与电源的连接。

### 8.1 外部清洁

仅使用肥皂和温水清洁洗衣机。请擦干所有表面。



**小心！**  
不要使用酒精、溶剂或化学制品。

### 8.2 除垢

日常使用的水中通常含有石灰。因此最好定期在洗衣机内使用水软化粉剂。

此项工作应与洗衣分开进行，并应遵照水软化粉剂制造商的使用说明。

这将有助于防止形成石灰质沉积物。

### 8.3 每次洗衣后

将机门敞开一会。这样做有助于防止洗衣机内部发霉和产生异味。在洗衣后将机门敞开还有利于保持门封的密封性。

### 8.4 利用“Tub Clean”程序进行保养洗涤

使用低温洗涤可能会导致残余物在洗衣桶内聚集。

我们建议定期使用“Tub Clean (桶清洗)”程序清洁洗衣桶，清除任何残余物。

若要执行保养洗涤：

- 洗衣桶内应该不含任何衣物。
- 选择“Tub Clean”程序。
- 使用正常清洁剂用量，必须是含生物性质的粉状。
- 按下启动/暂停，启动程序。

### 8.5 清洁投放抽屉盒

洗衣粉和洗涤剂投放抽屉盒应定期清洁。

向下按压卡钩并向外拉出，取下抽屉盒。在水龙头下冲洗抽屉盒内部，清除积聚的任何洗衣粉。

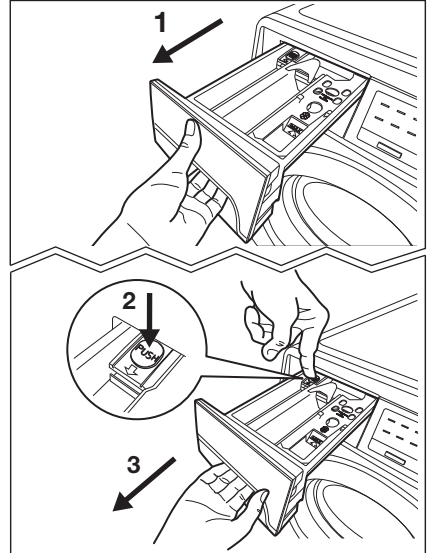

为了便于清洁，应拆下洗涤剂投放格的上部。

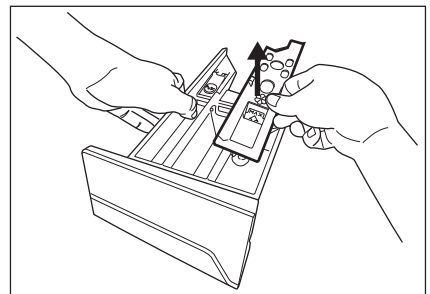

## 8.6 清洁抽屉盒的凹槽

取下抽屉盒后，使用小刷子清洁凹槽，确保去除凹槽上部和下部残留的所有洗衣粉。将抽屉盒放回原位，然后滚筒内不放衣物，空机运行一次漂洗程序。

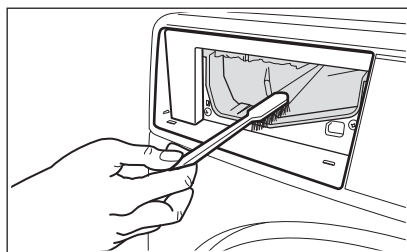

## 8.7 清洁排水泵

**i** 定期检查排水泵，确保排水泵清洁。

发生以下情况时清洁排水泵：

- 洗衣机不排水。
- 滚筒无法转动。
- 洗衣机会因为排水泵阻塞而发出异常噪音。
- 显示屏将因排水故障显示报警代码。

**!** 警告！

1. 从电源插座上拔下电源插头。
2. 洗衣机运行时不要取下过滤器。如果洗衣机内的水是热的，不要清洁排水泵。必须待水冷却后再清洁排水泵。

要清洁排水泵：

1. 打开排水泵门。

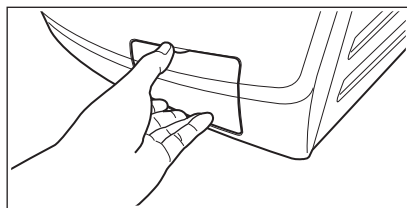

2. 拉盖下来，再挤的腿在盖两侧一起拉出（如图）。

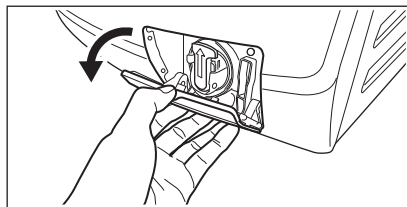



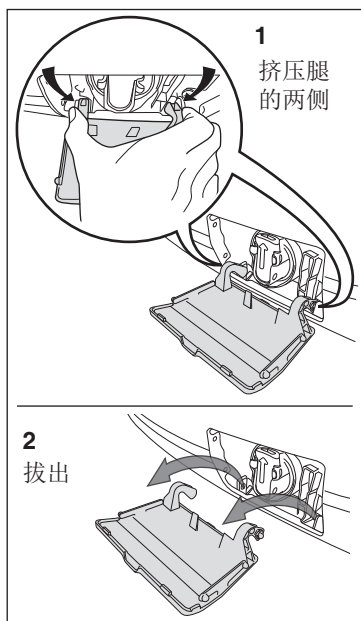

3. 在排水泵凹槽下方放置一个容器，以收集流出的水。

按压两个拨杆并向后拉动排水管，让水流出。

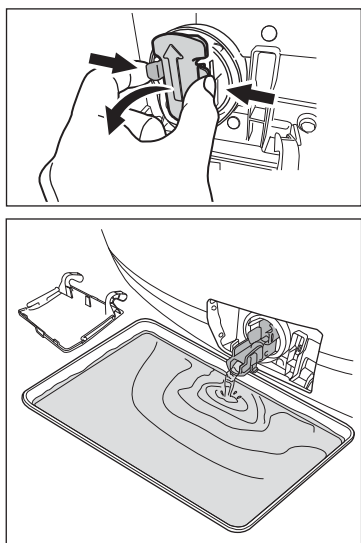

4. 容器水满后，将排水管放回原位，然后倒掉容器中的水。重复第 3 步，直到排水泵不再流水为止。

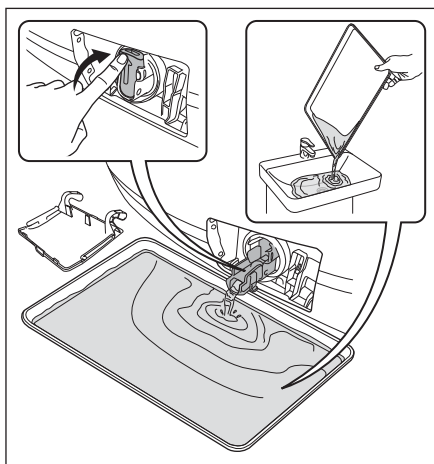

5. 将排水管退回原位，然后旋转过滤器以将其取下。

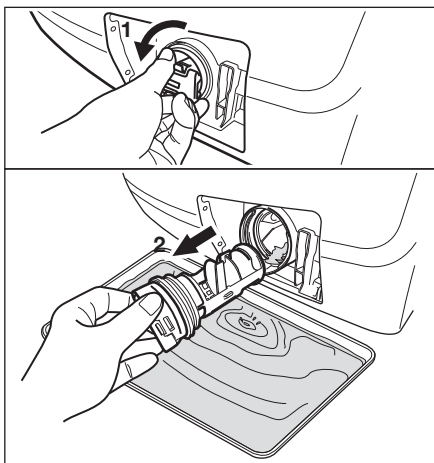

6. 清除泵中的絮状物和脏物（如果有的话）。

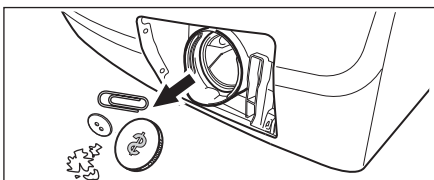

7. 确保泵轮可以转动。如果泵轮不转动，请与维修服务中心联系。

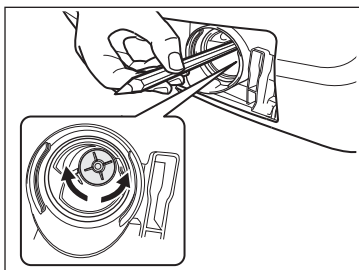

8. 在水龙头下清洗过滤器。

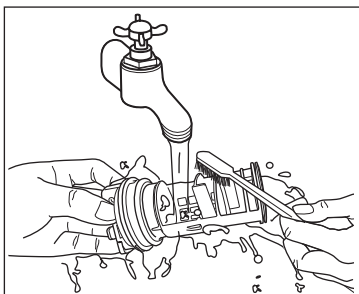

9. 将过滤器装回泵中的特殊导轨内。确保正确拧紧过滤器，以防止漏水。

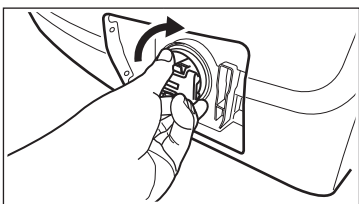

10. 将挡板推回原位，然后关闭排水泵门。

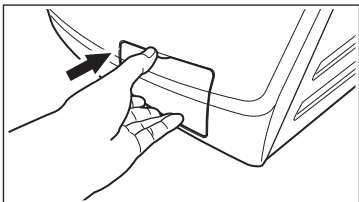

## 8.8 清洁进水管过滤器

如果您当地的水质很硬，或者水中含有石灰质沉积物，进水管过滤器可能会发生堵塞。因此最好时常清洁进水管过滤器。

要清洁进水管过滤器：

1. 关闭水龙头。
2. 从水龙头上卸下进水软管。
3. 使用硬毛刷清洁进水软管过滤器。

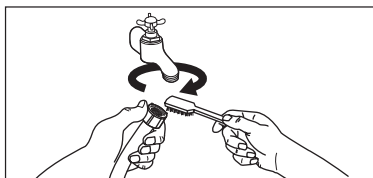

4. 卸下机背的进水软管。
5. 使用硬毛刷或毛巾清洁阀门中的过滤器。

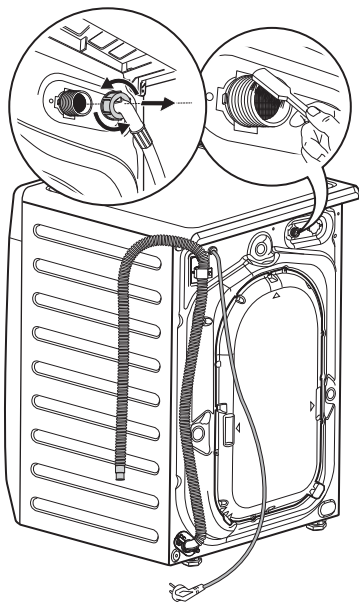

- 重新装好进水软管。确保连接牢固以防止漏水。

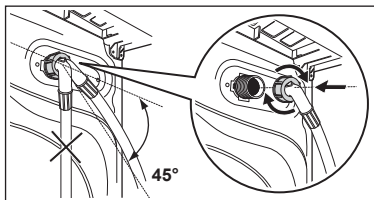

- 打开水龙头。

## 8.9 预防霜冻

如果洗衣机安装在温度可能降至  $0^{\circ}\text{C}$  以下的地方，请将进水软管和排水泵中残留的水排空。

### 紧急排水

- 从电源插座上拔下电源插头。关闭水龙头。
- 取下进水软管。
- 将排水软管从后部的管托上取下，然后从水槽或水龙头上摘下。

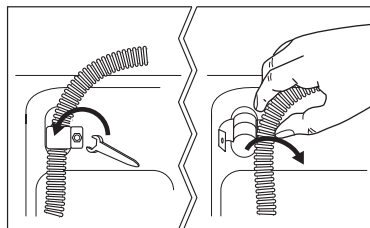

- 将排水软管和进水软管的末端放在一个容器内。让软管内的水流出。

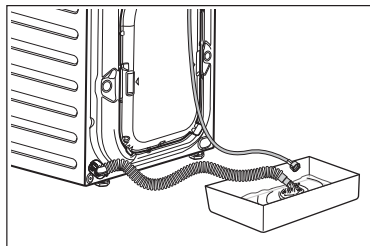

- 待不再有水流出时，重新装好进水软管和排水软管。



再次使用洗衣机前，确保周围温度高于  $0^{\circ}\text{C}$ 。

## 9. 故障诊断

### 9.1 可能的原因

某些问题是由于缺乏简单维护或疏忽造成的，这类问题无需求助专业人员，可以自己轻松解决。在联系当地维修服务中心之前，请先按照下表所列步骤进行检查。

故障排除后，请按启动/暂停按钮重新启动程序。如果进行全面检查后故障依然存在，请与当地维修服务中心联系。

 **审慎！** 停用该设备你做检查之前。

报警代码：

<b>E10</b>	洗衣机不进水。
<b>E20</b>	洗衣机不排水。
<b>E40</b>	机门未关闭或机门未完全关严。请检查门！
<b>E40</b>	主电源不稳定。等到电源稳定，电器就会自动开启。
<b>E91</b>	该设备的电子元件之间没有交流。关闭并重新开启。

故障	可能的原因 => 解决方法
洗衣机不启动：	• 机门未关闭。（故障代码：E40） => 关紧机门。
	• 插头未正确插入电源插座。 => 将插头正确插入电源插座。
	• 电源插座没电。 => 请检查您的家庭用电设施。
	• 没有按启动/暂停按钮。 => 按启动/暂停按钮。
	• 选择了预约（Delay End）程序。 => 如果要立即洗涤衣物，取消预约程序。
	• 主电源不稳定。（如果 E40 出现在显示屏上。） => 等到电源稳定，电器就会自动开启。
洗衣机不进水：	• 水龙头未打开。（故障代码：E10） => 打开水龙头。
	• 排水软管被挤压或扭结。（故障代码：E10） => 检查排水软管的连接。
	• 进水软管中的过滤器发生堵塞。（故障代码：E10） => 清洁进水软管过滤器。
	• 机门未完全关严。（故障代码：E40） => 关紧机门。
洗衣机进水，但随即又将水排出：	• 排水软管的末端太低。（故障代码：E10） => 参阅“排水”一节的相关段落。
洗衣机不排水或不脱水：	• 排水软管被挤压或扭结。（故障代码：E20） => 检查排水软管的连接。
	• 排水泵发生堵塞。（故障代码：E20） => 清洗排水过滤器。
	• 选择了“Extra Silent”或“Rinse Hold”选项。 => 按启动/暂停键，沥干水。要么选择脱水程序。
	• 滚筒内衣物摆放不均匀。 => 暂停运行洗衣机，重新手动将衣物摆放均匀。

故障	可能的原因 => 解决方法
地面上有水:	<ul style="list-style-type: none"> <li>• 使用了过量洗涤剂或不适合的洗涤剂（产生过量泡沫）。 =&gt; 减少洗涤剂用量或使用其他洗涤剂。（参考第 85 页。）</li> <li>• 检查进水软管连接处是否漏水。 这种情况有时可能不易察觉，因为水会沿着进水软管流下；因此请检查进水软管是否潮湿。 =&gt; 检查进水软管的连接。</li> <li>• 排水软管破损。 =&gt; 电话服务。</li> </ul>
洗衣效果不满意:	<ul style="list-style-type: none"> <li>• 使用了过少的洗涤剂或不适合的洗涤剂。 =&gt; 增加洗涤剂用量或使用其他洗涤剂。（参考第 85 页。）</li> <li>• 洗衣前没有预先处理顽固的污渍。 =&gt; 使用去污产品处理顽固污渍。</li> <li>• 没有选择正确的洗涤温度。 =&gt; 检查是否选择了正确的洗涤温度。</li> <li>• 洗涤的衣物量过多。 =&gt; 减少衣物量。</li> </ul>
机门无法打开:	<ul style="list-style-type: none"> <li>• 程序仍在运行。 =&gt; 等待洗衣程序结束。</li> <li>• 尚未解除机门锁定。 =&gt; 按下电源“开/关”按钮，启动本机。</li> <li>• 滚筒内有水。 =&gt; 要打开机门，必须排干水（请参见 82 页上的“打开机门”）。</li> <li>• 这个问题可能是由电器故障引起。 =&gt; 与服务中心联系。如果你需要打开门，请仔细阅读下页的“紧急开门”。</li> </ul>
洗衣机振动或有噪音:	<ul style="list-style-type: none"> <li>• 未拆除运输螺栓和包装材料。 =&gt; 检查洗衣机的安装是否正确。</li> <li>• 没有调节支撑脚。 =&gt; 检查洗衣机是否水平放置平稳。</li> <li>• 滚筒内衣物摆放不均匀。 =&gt; 暂停运行洗衣机，重新手动将衣物摆放均匀。</li> <li>• 筒内衣物太少。 =&gt; 装入更多衣物。</li> <li>• 地面不平稳，如木质地板。 =&gt; 参阅“洗衣机放置”一节的相关段落。</li> </ul>
程序运行时间超过显示时间:	<ul style="list-style-type: none"> <li>• 使用了过量的洗涤剂。 =&gt; 减少洗涤剂用量或使用其他洗涤剂。参见第 85 页“洗衣粉使用类型和用量”</li> <li>• 洗衣机放置位置不平。 =&gt; 重新手动摆放好滚筒内的衣物，然后重新开始脱水阶段。 参见“洗衣机放置”一节的相关段落。</li> </ul>

故障	可能的原因 => 解决方法
的周期比显示的时间短。	<ul style="list-style-type: none"> <li>设备根据衣物负载计算新的时间。</li> </ul>
脱水功能启动延迟或洗衣机不脱水：	<ul style="list-style-type: none"> <li>电子失衡检测装置已断开，因为滚筒内的衣物摆放不均匀。滚筒通过反向旋转重新摆放衣物。</li> </ul> <p>这种情况可能会在失衡情况消失前重复出现几次，然后才可以恢复正常脱水。如果 10 分钟后，滚筒内的衣物仍然无法摆放均匀，洗衣机将不会进行脱水。这种情况下，需要手动重新将衣物摆放均匀，然后再选择脱水程序。</p> <p>=&gt; 暂停运行洗衣机，重新手动将衣物摆放均匀。</p>
洗衣机发出异常噪音：	<ul style="list-style-type: none"> <li>洗衣机未正确安装。=&gt; 确保洗衣机水平放置平稳。请参见“安装”一节的相关内容。</li> </ul>
	<ul style="list-style-type: none"> <li>未拆除运输螺栓或包装物 =&gt; 确保拆除包装物和/或运输螺栓。请参见“拆除包装”一节的相关内容。</li> </ul>
	<ul style="list-style-type: none"> <li>衣物量可能过少。=&gt; 向滚筒内添加更多衣物。</li> </ul>
滚筒内看不到水：	<ul style="list-style-type: none"> <li>洗衣机采用先进技术，非常经济划算，用水极少又不影响洗衣性能。</li> </ul>

## 9.2 紧急开门

当遇停电情况下或设备门保持锁定状态。电源恢复时，该洗涤程序继续进行。但如果门仍然锁定在断电的情况下，可以使用紧急解锁功能来打开它。

开门之前：



### 警告！

确保水温和洗衣不热。如果必要，等到凉了才开门。



### 警告！

确保洗衣机滚筒不旋转。如果必要，等到洗衣机滚筒停止转动才开门。



### 警告！

确保洗衣机滚筒内的水位不会太高。进行紧急排水，如有必要（参考第 91 页，“紧急排水”）。

开门，步骤如下：

1. 按下按钮 “On/Off” 来切换装置关闭。
2. 拔下电源插头从主插口。
3. 打开过滤器盖。
4. 保持紧急解锁触发器（红色物体）向下拉扯，并在同一时间，打开电器箱门。

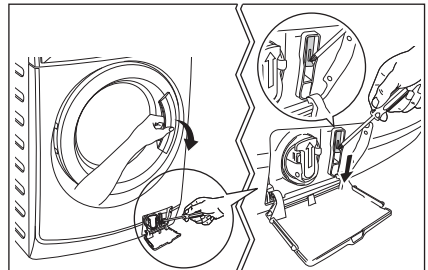

5. 取出衣物。
6. 关闭过滤器盖。



如果无法确定或解决问题，请与我们的维修服务中心联系。

在致电维修服务中心之前，请记住您的洗衣机的型号、序列号和购买日期：维修服务中心需要这些信息来为您解决问题。

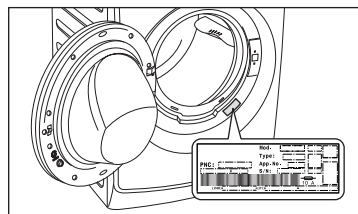

## 10. 技术参数

尺寸（高/宽/深）	85 X 60 X 66.9 cm	
电源（电压/频率）	220-240 V / 50 Hz	
吸收的总功率	2100 W	
最小熔断保护	10 A	
供水压力（最大/最小）	0.8 MPa / 0.05 MPa	
最大衣物量（晾衣服）	Cottons	11 Kg
	Mixed	4 Kg
	Delicates	4 Kg
	Daily 60	5.5 Kg
	Quick 18	1.5 Kg
	Refresh	1.5 Kg
	Baby Care	4 Kg
	Sports	2.5 Kg
	Wool	2 Kg
	Energy Saver	11 Kg
	Spin	11 Kg
Rinse + Spin	11 Kg	
Bedding	3 Kg	
Heavy Duty	11 Kg	
脱水速度（最快/最慢）	1400 rpm / 400 rpm	

# 11. 安装

## 11.1 拆除包装

**小心：** 在使用洗衣机前，必须拆除所有运输螺栓和包装物。建议保留所有的运输装置以备日后再次运输洗衣机时使用。

1. 佩戴手套。剪切和删除 4 条出条带，如图所示。

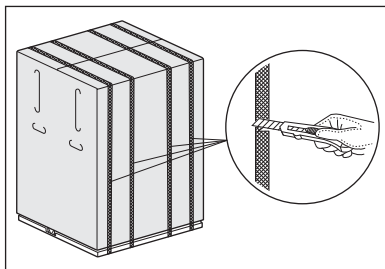

2. 取下纸箱盒。取出所有聚苯乙烯泡沫包装材料。撕掉洗衣机外覆的塑料包装袋。

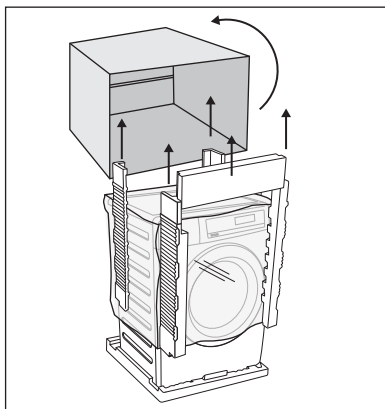

3. 打开机门。取出门封处的聚苯乙烯泡沫块以及洗衣滚筒内的所有物品。

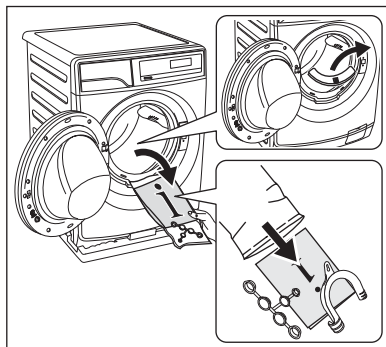

4. 将其中一块聚苯乙烯泡沫包装放在洗衣机后面的地面上。小心地将洗衣机背面朝下平放在地面上。确保不要损坏水管。

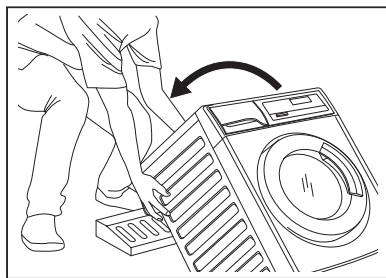

5. 拆下聚苯乙烯泡沫底座。

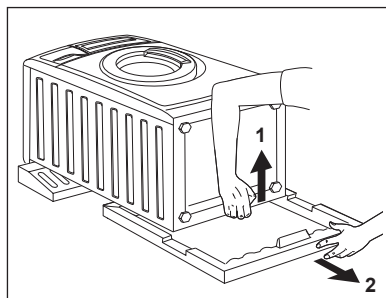

6. 垂直向上拉起洗衣机。
7. 将电源线以及进水和排水软管从洗衣机背部的管夹 (A) 上取下。



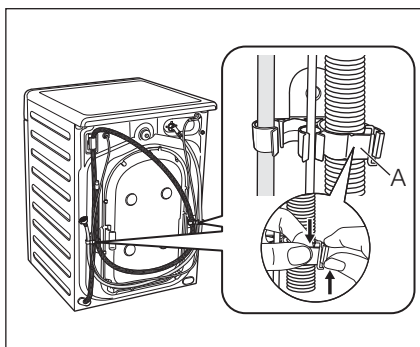

8. 拆下三个运输螺栓。
9. 拔出塑料垫片。

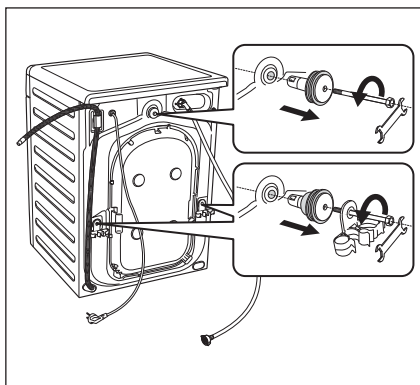

10. 在孔口处盖上塑料盖。您可以在用户手册的包装袋中找到这些塑料盖。

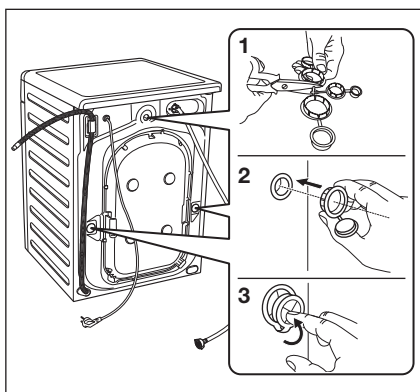

## 11.2 洗衣机放置

为了保证洗衣机能够正常工作，请务必将洗衣机放置于坚实平坦的地面。

不得将洗衣机安装在带锁门、推拉门或合页位置与机门相对从而会限制机门打开的门后。

在洗衣机顶部和侧面放置水平尺，检查水平情况。

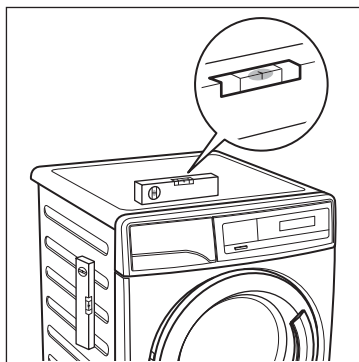

如果没有水平尺，可利用门框边缘、纸板或台面作为参照物，检查洗衣机是否处于水平状态。

可以松动或收紧底脚来调节水平。正确调节洗衣机的水平情况，可防止洗衣机在运行过程中出现振动、噪音和位移。

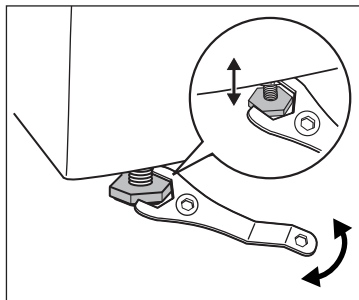

调整好洗衣机的水平之后，尝试从各个边角摇动它。如果洗衣机发生晃动，请再次调整底脚，直到洗衣机保持水平并且不再摇晃为止。

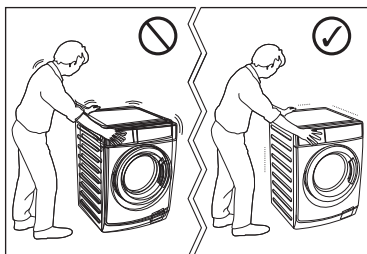

切勿在洗衣机底部放置纸板、木块或类似物品来调节地面的不平整。

将洗衣机放置在平整坚实的地面上。确保地垫、地毯等不会阻碍洗衣机周围的空气流通。

检查并确认洗衣机没有接触墙壁或橱柜。

## 11.3 进水

将进水软管连接到 3/4" BSP 螺纹的水龙头。

请使用洗衣机随附的软管。不要使用旧的软管。

进水软管的另一端连接到洗衣机，可向任意方向自由转动。

松开接头配件，转动软管，再重新紧固接头配件，确保不会漏水。

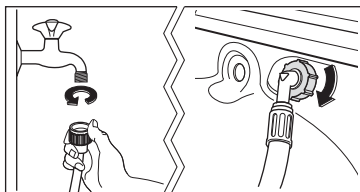

进水软管不可延长。如果软管太短而又不想移动水龙头，可另外购买一根洗衣机进水专用的加长软管。

## 11.4 排水

排水软管的末端可采用三种方式放置：

- 使用随机附带的塑料软管导向套吊装在洗手池边缘上方。

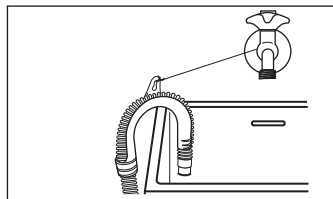

采用这种方式时，请确保出水端不会在洗衣机排水过程中脱落。要做到这一点，可将排水软管系在水龙头上或固定在墙上。

- 连接到洗手池的排水管道分支。此分支必须位于存水弯上方，从而使排水软管的弯曲部分至少高于地面 60 cm。
- 直接与排水管道相连，高度应在 60 cm 至 90 cm 之间。排水软管出水端必须保持畅通，即排水管道的内径必须大于排水软管的外径。

排水软管不得扭结。请将排水软管沿地面放置，只有接近排水口的部分必须提高。

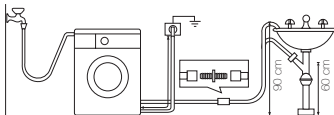

为使洗衣机能够正常工作，排水软管必须卡在机背上部的适当管托上。

## 11.5 电气连接

本洗衣机设计使用 220-240 V 单相 50 Hz 电源。



连接电源之前，请检查额定标签上提及的额定电源条件。

“使用不正确的电源可能会使保修失效。”

请检查并确保您的家庭用电设施可以承受需要的最大负载（2.1 kW），同时要考虑正在使用的任何其他电器。



### 小心！洗衣机必须连接至接地插座。

对于因不遵守上述安全预防措施而造成的洗衣机损坏或人员伤害，制造商概不负责。



### 电源线的更换应由我们的维修服务中心完成。

安装洗衣机时，必须确保能够轻松连接电源线。

如果利用接线板或便携式插线装置为洗衣机供电，必须妥善放置接线板或便携式插线装置，确保其不会溅上液体或受潮。

## 12. 关注环保

### 12.1 包装材料



标有  符号的材料可以循环利用。

>PE<=polyethylene

>PS<=polystyrene

>PP<=polypropylene

这表示此类材料如果正确放入适当回收容器内处理，可以循环利用。

### 12.2 废旧洗衣机

选择经过授权的废物处理点处置您的废旧电器。请为保持环境整洁贡献您的力量！

产品或产品包装上标记的  符号表示此产品不可作为生活垃圾处理。

而是应送至适当的收集点，作为电气电子设备进行回收利用。

确保正确处置本产品将有助于防止因本产品的不当废物处理而可能对环境 and 人体健康造成的负面影响。

有关回收利用本产品的更多详细信息，请联系您当地的市政办公机构、生活垃圾处理服务站或您购买产品的商店。

### 12.3 环保提示

为了节水节能和保护环境，我们建议您遵循下列提示：

- 为了节省洗涤剂、用水和洗衣时间（也可以保护环境），脏污程度一般的衣物可以不进行预洗。
- 洗衣机满载衣物运行时会更加经济。
- 对衣物进行适当预处理可去除污渍和轻微的脏污，从而可以选择较低温度洗涤衣物。
- 根据水质硬度、衣物脏污程度和衣物量取用适量的洗涤剂。

www.electrolux.com



G0011696-002-A00973011

