



Instruction Book/说明书/説明手冊/ 사용설명서/Buku Petunjuk/ คู่มือการใช้งาน/Sách hướng dẫn

Pure C9

Bagless canister vacuum cleaner/

无袋式真空吸尘器/

集塵盒臥式插電吸塵器/

유선 진공 청소기/

Penyedot debu tanpa kantong penampung/

เครื่องดูดฝุ่นแบบกล่องเก็บฝุ่น/

Máy hút bụi dạng hộp không túi

| | | |
|----|-----------------------|----|
| GB | INSTRUCTION BOOK..... | 2 |
| SC | 说明书..... | 10 |
| CT | 説明手冊..... | 18 |
| KO | 사용설명서..... | 26 |
| BI | BUKU PETUNJUK..... | 34 |
| TH | คู่มือการใช้งาน..... | 42 |
| VN | SÁCH HƯỚNG DẪN..... | 50 |

1 OVERVIEW OF THE PRODUCT

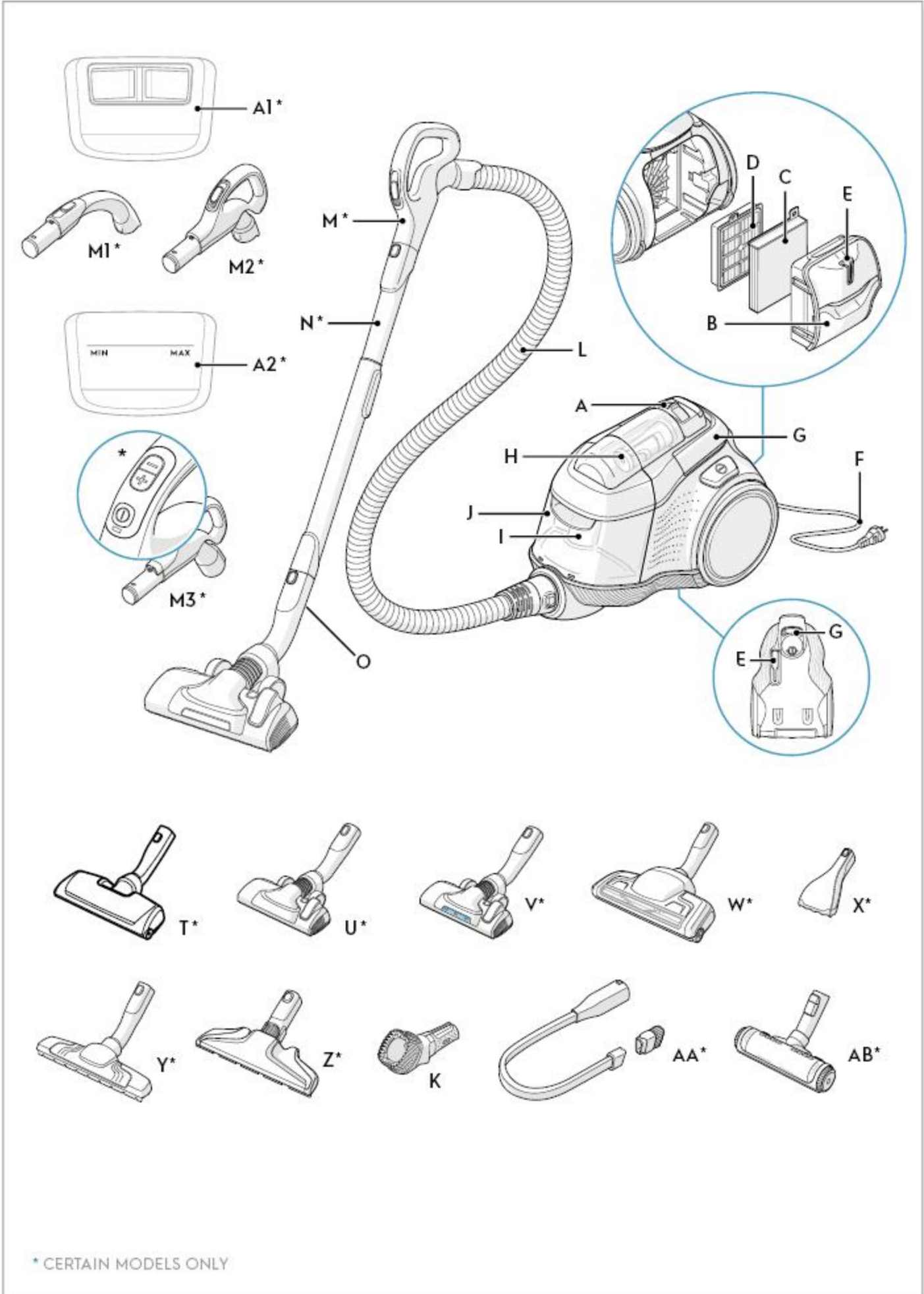

* CERTAIN MODELS ONLY

2 INSTALLATION

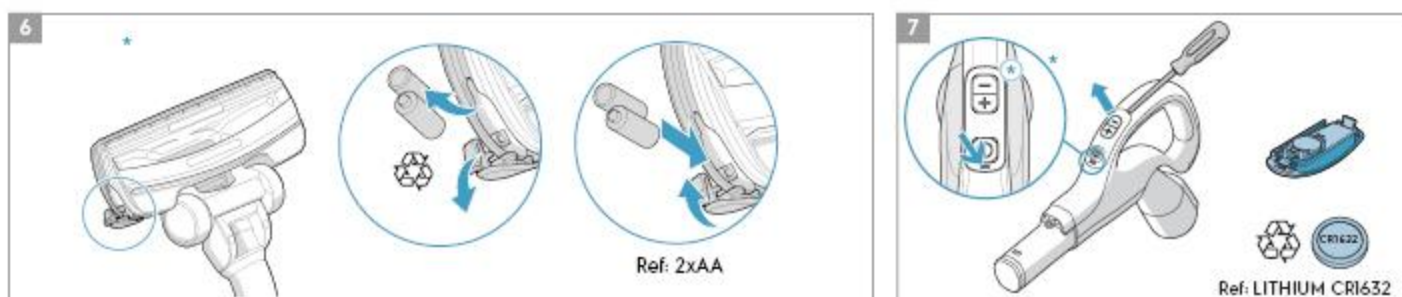
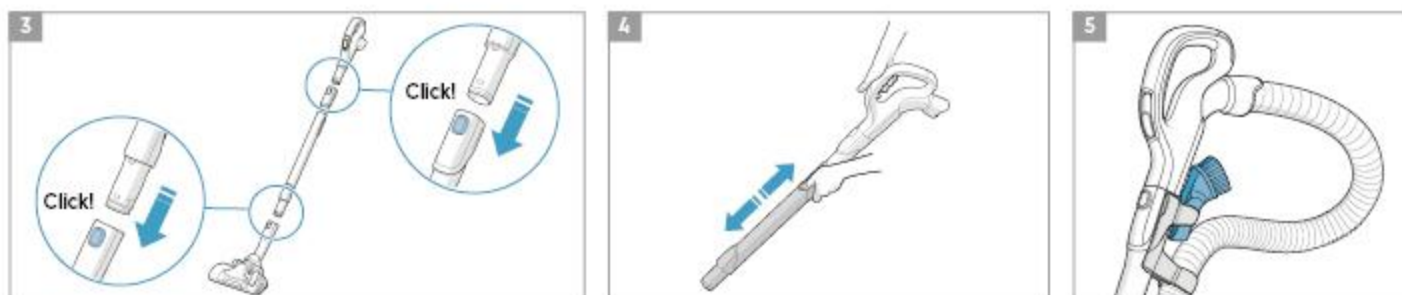
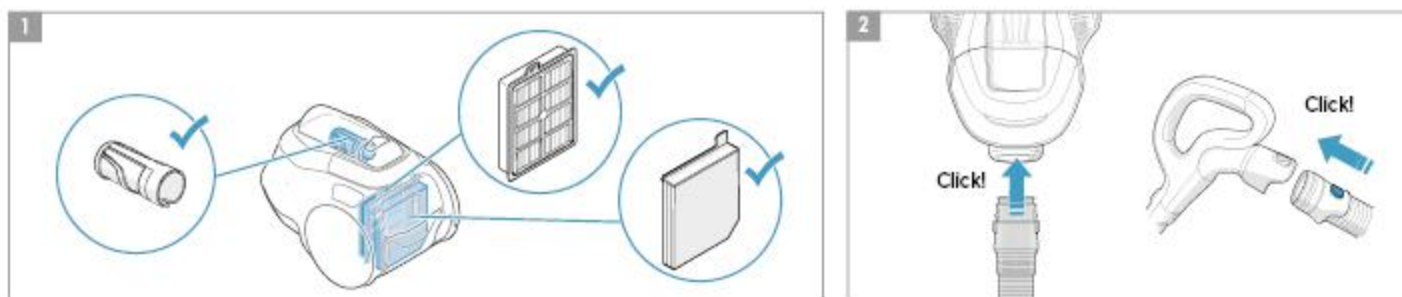

3 USING THE PRODUCT

* CERTAIN MODELS ONLY

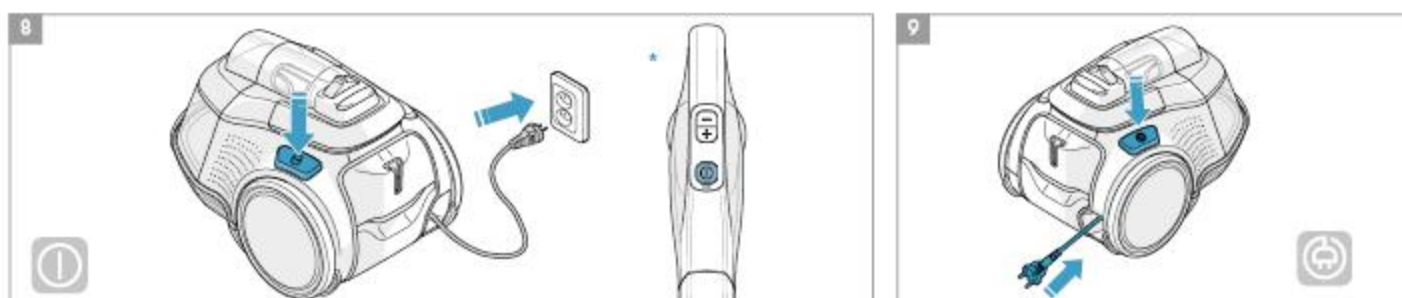

3 USING THE PRODUCT

* CERTAIN MODELS ONLY

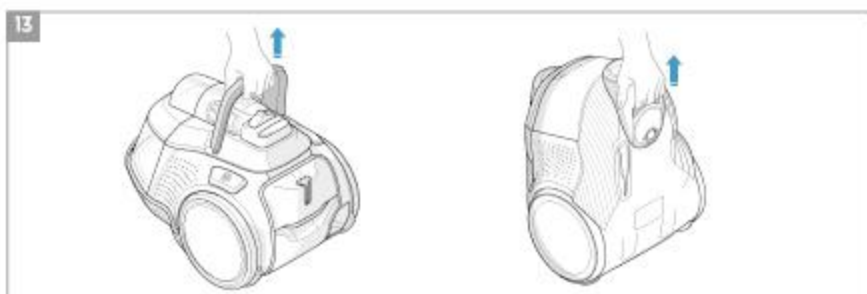
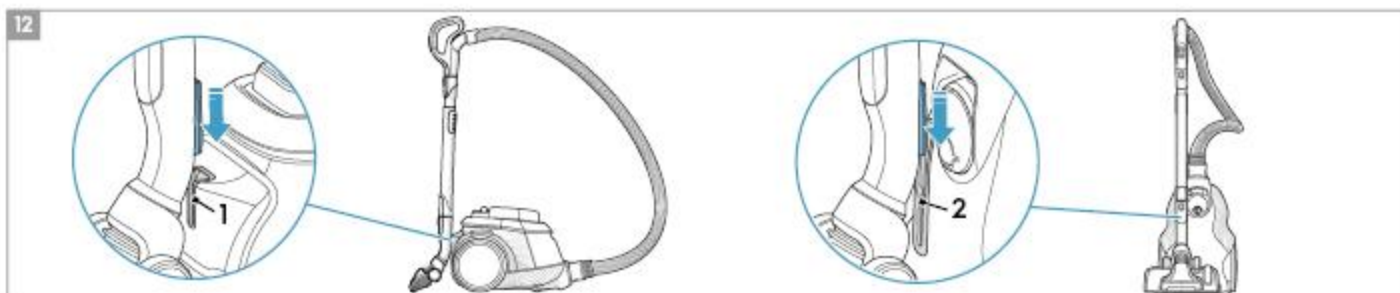

4 DUST EMPTYING

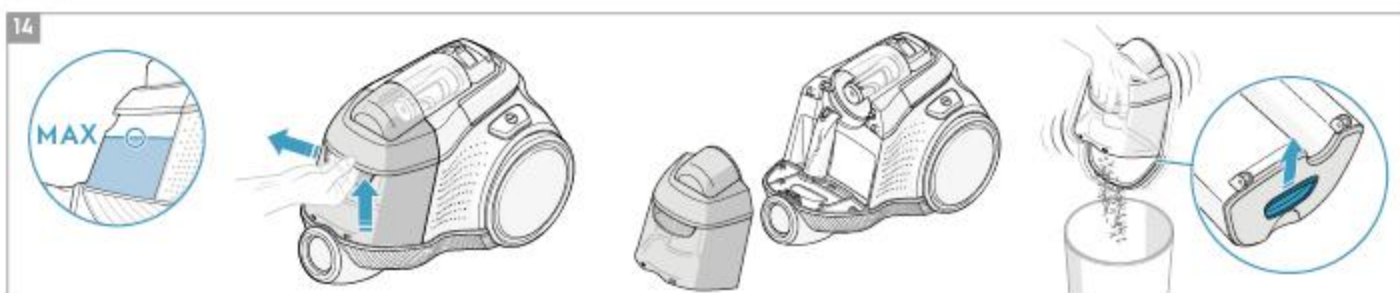

5 CLEANING THE FILTERS

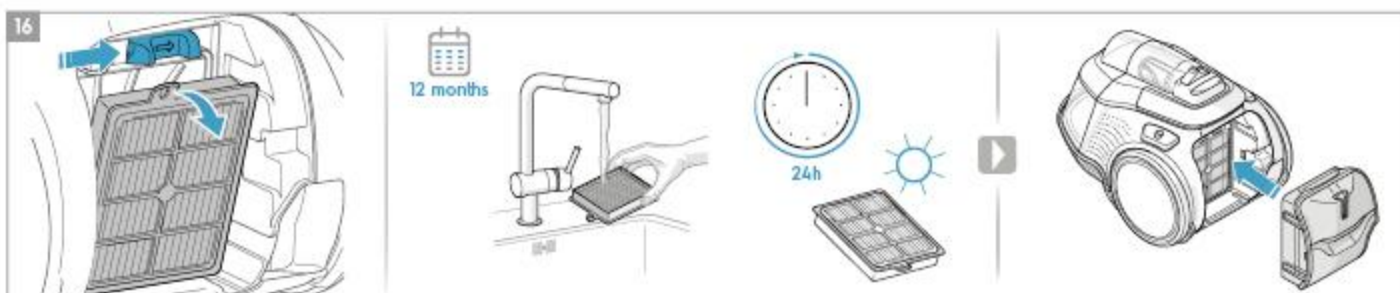
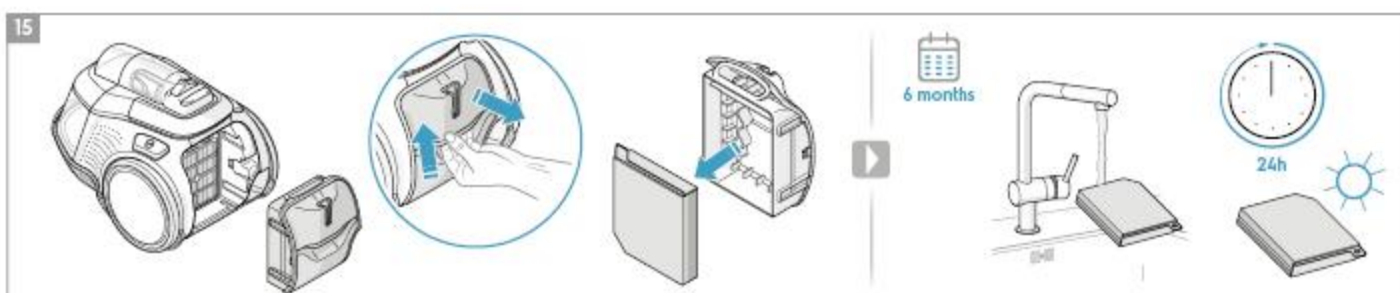

5 CLEANING THE FILTERS

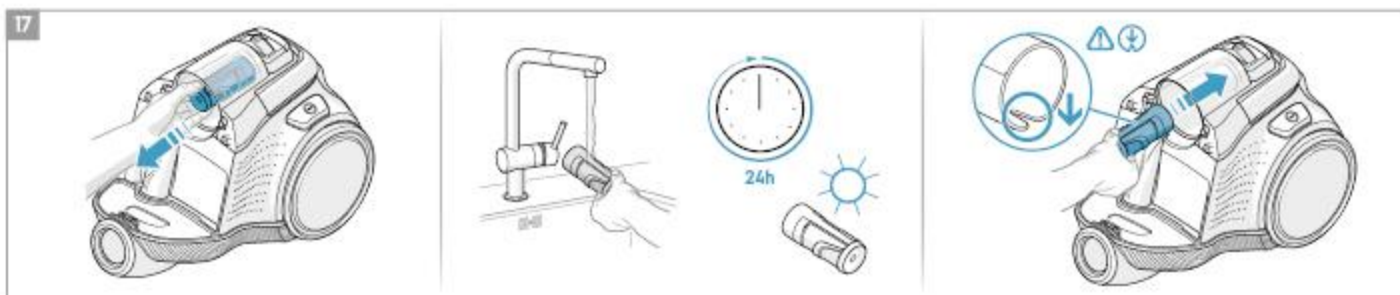

6 MAINTENANCE

* CERTAIN MODELS ONLY



7 SYSTEM CHECK

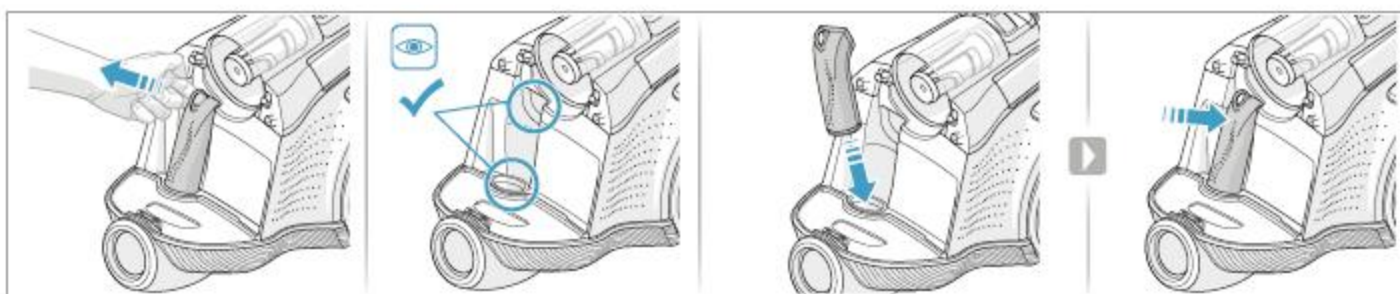
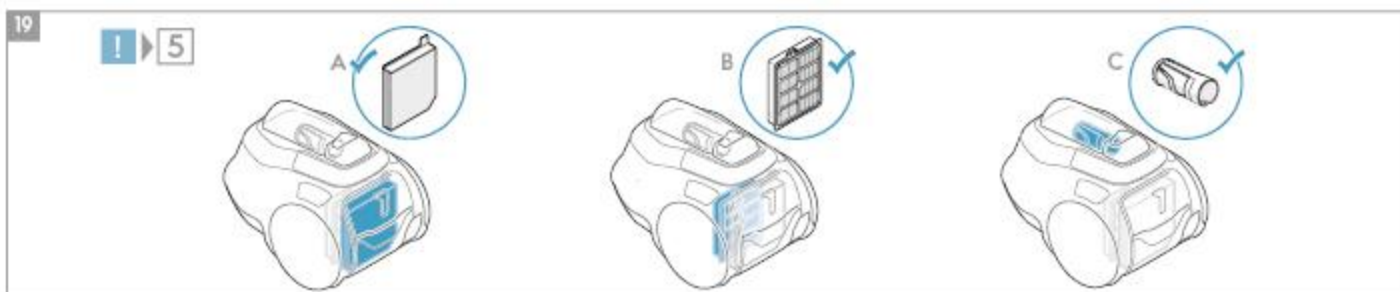

SAFETY PRECAUTIONS

This appliance can be used by children aged from 8 years and above and persons with reduced physical, sensory or mental capabilities or lack of experience and knowledge if they have been given supervision or instruction concerning use of the appliance in a safe way and understand the hazards involved.

Children should be supervised to ensure that they do not play with the appliance.

Cleaning and maintenance shall not be done by children without supervision.

WARNING: Turbo nozzles* have a rotating brush where parts can get entrapped. Please use them with caution and only on intended surfaces. Please turn the vacuum cleaner off before removing entrapped parts or cleaning the brush.

Batteries must be removed from the remote control in the handle* / LED lighted nozzle* before scrapping the product**.

**Certain models only.*

****Information on how to remove the battery is in section 6 and 7.**

Always disconnect the plug from the mains before cleaning or maintaining the appliance or when removing the battery. The battery is to be disposed of safely.

If the cord is damaged, it must be replaced only by an authorized Electrolux service centre in order to avoid a hazard.

Pure C9 should only be used for normal vacuuming indoors and in a domestic environment. Make sure the vacuum cleaner is stored in a dry place.

All service or repairs must be carried out by an authorized Electrolux service centre.

Packaging material, e.g. plastic bags should not be accessible to children to avoid suffocation.

Never use the vacuum cleaner:

In wet areas.

Close to flammable gases, etc.

When the product shows visible signs of damage.

On sharp objects or fluids.

When the floor nozzle shows visible signs of a damages.

On hot or cold cinders, lighted cigarette butts, etc.

On fine dust, for instance from plaster, concrete, flour, hot or cold ashes.

Do not leave the vacuum cleaner in direct sunlight.

Avoid exposing the vacuum cleaner to strong heat or freezing temperatures.

Never use the vacuum cleaner without its filters.

Do not try to touch the brush roll while the cleaner is switched on and the brush roll is turning.

When the wheels are blocked.

Do not use your vacuum cleaner if the filters are damaged or broken.

Power cord precautions

Check the plug and cord regularly. Never use the vacuum cleaner if the plug or cord is damaged.

Damage to the vacuum cleaner's cord is not covered by the warranty.

Never pull or lift the vacuum cleaner by the cord.

Using the vacuum cleaner in the above circumstances may cause serious personal injury or damage to the product. Such injury or damage is not covered by the warranty or by Electrolux.

SERVICING AND WARRANTY

All service or repairs must be carried out by an authorized Electrolux service centre.

Damage to the vacuum cleaner's cord is not covered by the warranty.

Damage to the motor caused by; vacuuming liquid, immersing appliance in liquid or using appliance with a damaged hose and nozzle is not covered by the warranty.

DISPOSAL



This symbol on the product indicates that this product contains a battery which shall not be disposed with normal household waste.



This symbol on the product or on its packaging indicates that the product may not be treated as household waste.

To recycle your product, please take it to an official collection point or to an Electrolux service center that can remove and recycle the battery and electric parts in a safe and professional way. Follow your country's rules for the separate collection of electrical products and rechargeable batteries.

Hereby, Electrolux Home Care and SDA, declares that the Vacuum Cleaner with radio equipment type FOR1, FOR2 and FOR3 is in compliance with Directive 2014/53/EU.

ENGLISH

Thank you for choosing Electrolux Pure C9 vacuum cleaner. Always use original accessories and spare parts to get the best results. This product is designed with the environment in mind. All plastic parts are marked for recycling purposes.

BEFORE STARTING

- Read this manual carefully.
- Check that all parts described are included.
- Pay special attention to the safety precautions!

DESCRIPTION OF PURE C9 VACUUM CLEANER

| | |
|--|--|
| A. Display | Nozzle Accessories |
| A1 rotary knob control* | K. AeroPro 3in1 tool |
| A2 remote control* | T. Motorized nozzle* |
| B. Filters lid | U. FlowMotion nozzle* |
| C. Fine dust filter | V. FlowMotion LED nozzle (with front lights)* |
| D. Pre-motor filter | W. AeroPro Turbo nozzle* |
| E. Parking slots | X. AeroPro Mini Turbo nozzle* |
| F. Power cord | Y. ParkettoPro nozzle* |
| G. Carry handle | Z. AeroPro FlexProPlus nozzle* |
| H. Cyclone compartment and nose cone filter | AA. AeroPro Long crevice nozzle* |
| I. Air channel | AB. BedPro nozzle* |
| J. Dust compartment | |
| L. AeroPro hose | |
| M. AeroPro handle | |
| M1 AeroPro Classic handle* | * Selected models only |
| M2 AeroPro Ergo handle* | |
| M3 AeroPro Remote Control handle* | |
| N. AeroPro telescopic tube | |
| O. Parking clip | |

Picture page 2-6

HOW TO USE THE VACUUM CLEANER

- 1 Check that all filters are properly placed before using the vacuum cleaner.
- 2 Insert the hose into the cleaner (to remove it, press the lock buttons and pull). Insert the hose into the hose handle until the lock button clicks (to release it, press the lock button and pull).
- 3 Attach the telescopic tube to the nozzle. Attach the telescopic tube to the hose handle (to remove it, press the lock button and pull).
- 4 Adjust the telescopic tube by holding the lock with one hand and pulling the handle with the other hand.

3IN1 ACCESSORY TOOL

- 5 You can fasten the clip-on holder and 3in1 tool under the handle to have it easily accessible. The tool has 3 functions, see pictures on next page.

CHANGING THE BATTERIES*

- 6 Nozzle with front lights*: Before first use, remove the protective film (on top of the batteries). Change batteries when front lights start blinking fast. Use 2 AA batteries.
- 7 Handle with remote control*: Change battery when light indicator turns red or is not responding when pressing any button. Use only batteries type LITHIUM CR1632.

NB: Remove the batteries from the product before scrapping. Follow your country's rules for collection of batteries and electrical products.

START/STOP THE VACUUM CLEANER AND ADJUST SUCTION POWER

- 8 Pull out the power cord and plug it into the mains. Press the ON/OFF button to turn the cleaner on/off. Models with remote control can also be operated by the ON/OFF button on the handle.*
- 9 After cleaning, push the REWIND button to rewind the cable.
- 10 Adjust suction power (manual control models): Turn the rotary knob on the cleaner or use the air valve on the handle.*
Adjust suction power (remote control models): Press +/- button on the handle. MIN/MAX and symbols indicators on display will show level of power.*

VACUUMING WITH THE UNIVERSAL NOZZLE (V*, W*)

- 11 Change nozzle setting with the pedal. Icon illustrates recommended floor type (hard floor or carpet).

FlowMotion LED nozzle*: Move the nozzle forward. The front light turns on automatically after a few seconds. When the nozzle is not used, the light turns off automatically after a few seconds.

PARKING POSITIONS, MOVING THE VACUUM CLEANER

- 12 Use parking position (1), at the back of the vacuum cleaner, when you pause while vacuuming.
Use parking position (2), underneath the vacuum cleaner, to carry and store the vacuum cleaner.
- 13 The vacuum cleaner has two carrying handles.

EMPTYING THE DUST COMPARTMENT

- 14 Empty the dust compartment when the level of dust has reached the maximum limit (*MAX*-mark).
Press the release button and pull to remove the dust compartment. Hold the dust compartment over a dust bin. Press the unlock button underneath the lid, open the lid by swinging it outwards. Empty dust into the dustbin. Refit in reverse order.

REPLACING THE FILTERS

- 15 Pull the FILTER button to open the filter lid.
Clean the fine dust filter after six months of use, or when dust is visible. Pull the tab on the frame to remove the fine dust filter. Rinse the filter under running water.
NB: Do not use cleaning agents. Let the filter dry completely (min. 24 h in room temperature) before putting back!
- 16 Press and slide the lock mechanism to the right to release the pre-motor filter. Remove the filter by pulling the filter frame tab.
Clean the pre-motor filter after twelve months of use.
Only use original s-filter Recommended by Electrolux (See Consumables and Accessories). Rinse the inside (dirty side) in lukewarm tap water. Tap the filter frame to remove the water. Repeat the process four times.
NB: Do not use cleaning agents. Avoid touching the filter surface. Let the filter dry completely (min. 24 h in room temperature) before putting back! Change the washable filter at least once a year or when it is very dirty or damaged.
After replacing the filters, close the filter lid until it is clicked back into place.
- 17 Cleaning the nose cone filter: the nose cone filter is located inside the cyclone compartment. Clean the nose cone filter if dust has entered. Pull the nose cone filter to remove. Remove dust with your hand. Clean under running water if heavily soiled. Refit in reverse order.
NB: Do not use cleaning agents. Let the filter dry completely (min. 24 h in room temperature) before putting back!









CLEANING THE UNIVERSAL NOZZLE (V*, W**) AND THE TURBO NOZZLE (X*)

- 18 Disconnect the universal nozzle from the tube. Clean with the hose handle.
Disconnect the turbo nozzle from the tube and remove entangled threads etc by snipping them away with scissors. Use the hose handle to clean the nozzle.*

Enjoy a great cleaning experience with Pure C9!

Electrolux reserves the right to change products, information and specifications without notice.

TIPS ON HOW TO GET THE BEST RESULTS

| NOZZLE/ACCESSORY | USE FOR: | NOZZLE/ACCESSORY | USE FOR: |
|--|---|---|---|
| T. Motorized nozzle*  | Carpet nozzle: - Motorized nozzle gives the best dust pick-up and deep cleaning of carpets through the rotating brush roller agitating the carpet. - Do not leave the motorized nozzle stationary with brush roller on. | U. FlowMotion nozzle* V. FlowMotion LED nozzle*  | Universal nozzle: - For all floor types, secures best dust pick up on both carpets and hard floors. - Change nozzle setting with the pedal. Icon will show recommended floor type. - Front light helps to detect dust and dirt in dark spaces (under furniture etc). <i>PureVision only</i> |
| | | X. Mini Turbo nozzle*  | Upholstery nozzle: - Brushes and vacuums at the same time (best pick up of hair, fibres etc). - For textile furniture, car seats, mattresses etc. - Brush roller is driven by the airflow of the vacuum cleaner. - Not suitable for carpets with very deep pile and long fringes as it can get stuck in the rotating brush roll. |
| W. Turbo nozzle*  | Carpet nozzle: - Brushes and vacuums at the same time (best pick up of hair, fibres etc). - Brush roller is driven by the airflow of the vacuum cleaner. - Not suitable for carpets with very deep piles and long fringes, anti-slip carpets like door mats or water resistant carpets. Use universal nozzle instead. | Z. FlexProPlus nozzle*  | Hardfloor nozzle: - For reach under/between furniture, corners and other obstacles. - Can easily turn 180 degrees for direct access to narrow spaces. |
| Y. ParkettoPro nozzle*  | Hard floor nozzle: - For gentle cleaning of hard floor (parquet, wooden floor, tiles etc). - Best dust pick up on hard floor with crevice. | AB. BedPro nozzle*  | Bed nozzle: - Removes dirt and dust mites from bedding and mattresses. |
| AA. Long crevice nozzle*  | Extra long tool: - For areas hard to reach (top of shelves etc). - For narrow spaces (behind radiators, under car seats etc). | K. 3in1 accessory tool*  | 3 tools in 1: 1. Dusting tool for hard surfaces (bookshelves, skirting boards etc). 2. Upholstery tool for textiles (curtains, upholstery etc). 3. Crevice tool for narrow spaces (behind radiators etc). |

Models with manual power regulation
 – follow graphics on cleaner for optimal performance.

TROUBLESHOOTING

| PROBLEM | SOLUTION |
|--|---|
| The vacuum cleaner does not start | <ul style="list-style-type: none"> • Check that the cable is connected to the mains. • Check that the plug and cable are not damaged. • Check for a blown fuse. • Check if the battery indicator lamp in the remote control handle responds (certain models only). |
| The cleaner stops | The cleaner might be overheated: disconnect it from the mains; check if the nozzle, tube, hose or filters are blocked. Let the cleaner cool down for 120 minutes before plugging it in again. If the cleaner still does not work, contact an authorized Electrolux service centre. |
| Reduction of suction capacity versus normal | <ul style="list-style-type: none"> • Check if the dust compartment is full or blocked. • Check if the air channel and inlet or outlet connection is blocked and needs to be cleared. • Check if the pre-motor filter is clogged and needs changing. • Check if nozzle is blocked and needs to be cleared. • Check if hose is blocked by squeezing it gently. However, be careful in case the obstruction has been caused by glass or needles caught inside the hose. Note: The warranty does not cover any damage to the hose caused by cleaning it. |
| Water has been sucked into the vacuum cleaner | It will be necessary to replace the motor at an authorized Electrolux service centre. Damage to the motor caused by the penetration of water is not covered by the warranty. |
| For any further problems, contact an authorized Electrolux service centre. | |

CONSUMABLES & ACCESSORIES



Buy Consumables & Accessories for your appliance:

www.electroluxshop.co.kr
<https://shop.electrolux.com.au/>

Availability of Consumables & Accessories varies by region and country.
 Please refer to our local Electrolux website for more details or contact local customer service hotline for support.

S-FILTER



PureAdvantage D11 Washable
 (Australia, New Zealand)

HEPA 13 washable

S-FRESH



Crispy Bamboo
 Tropical Breeze
 Brown Sugar & Fig
 Evening Rose
 Citrus Burst

NOZZLE*



Silent Parketto



DustMagnet Silent

KITS



Delicate Care KIT



Clean & Tidy KIT

* Availability of accessory is dependent on tube dimension

CUSTOMER CARE AND SERVICE

When contacting Service, ensure that you have the following data available:

- Model Number
- PNC number
- Serial number

The information can be found on the rating plate.

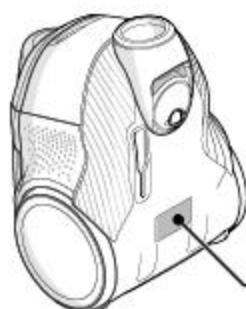

Model Number PNC Number Serial Number

| | | | |
|-------------------|------------------|---|---------------------------|
| Electrolux | | | Type FNA |
| Model Code TBD | PNC 910287894 | Ec. 00 | Serial Number 12345678 |
| | | 230 V ~ 50 Hz | 550 W NCM |
| | | Made in EU Electrolux Appliances AB S-16188 Angren, SE SE-100 40 Stockholm, Sweden | |

VISIT OUR WEBSITE TO:



Get usage advice, brochures,
 trouble shooter, service information:
www.electrolux.com

1. 产品概览

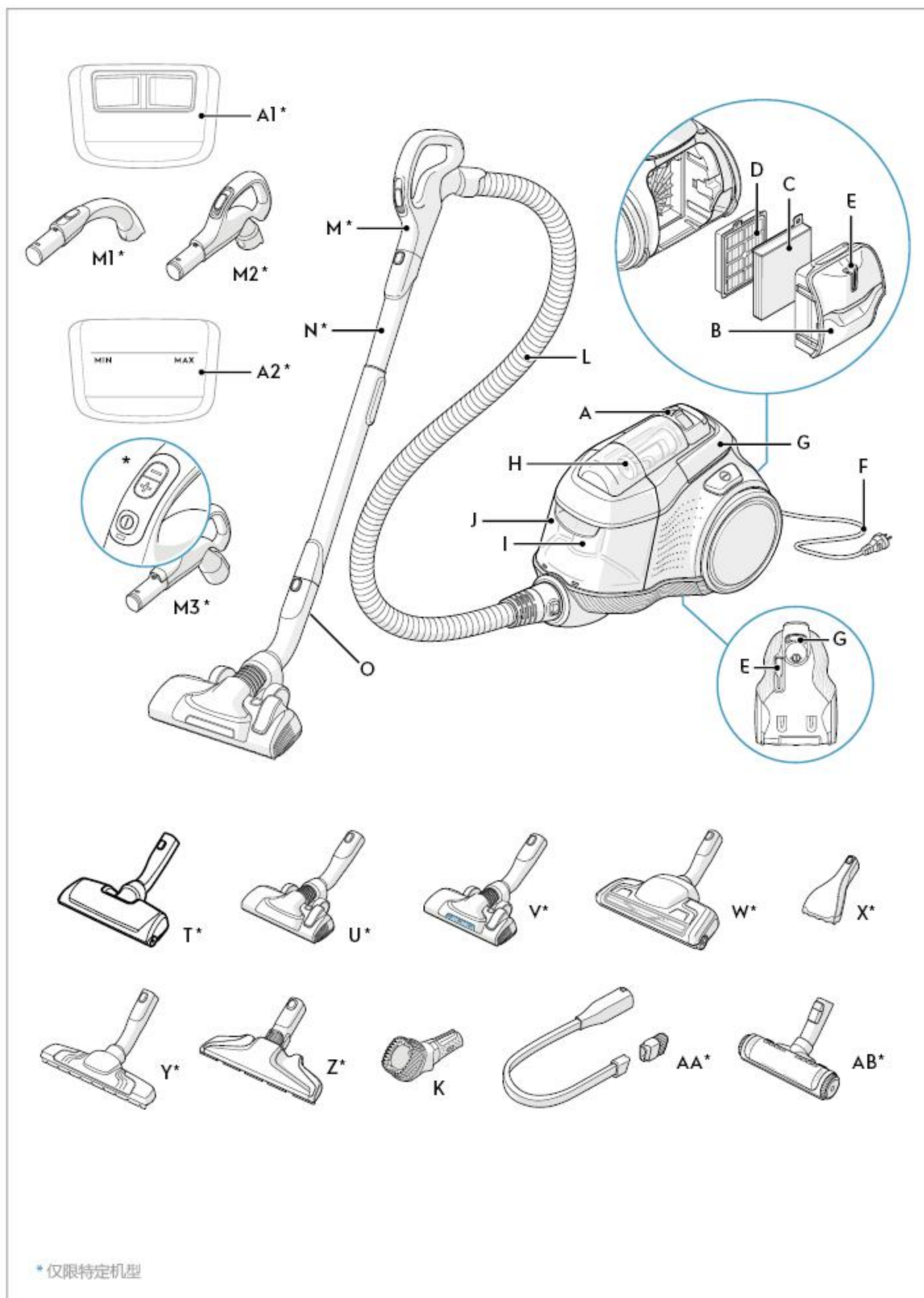

2. 安装

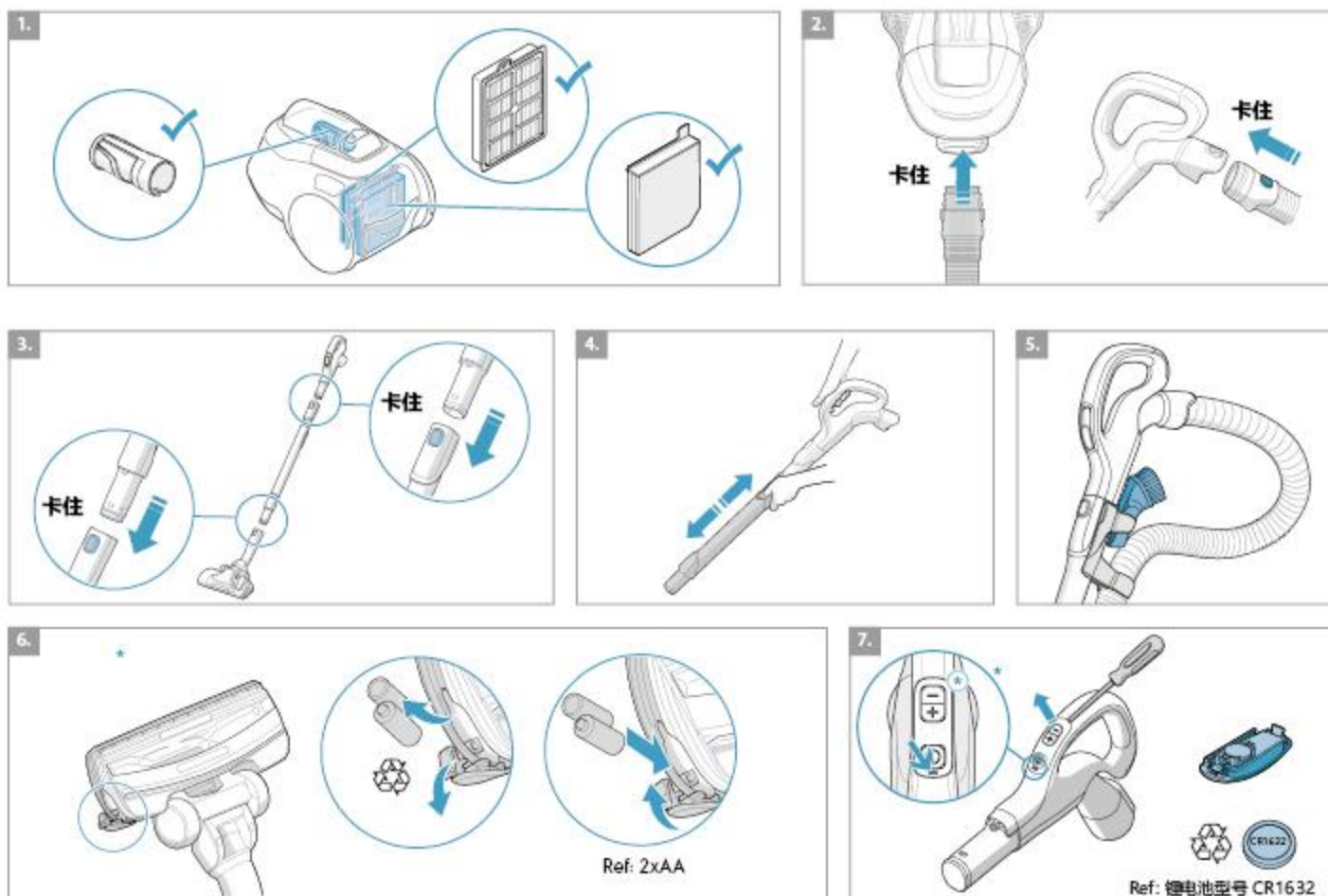

3. 使用产品

* 仅限特定机型

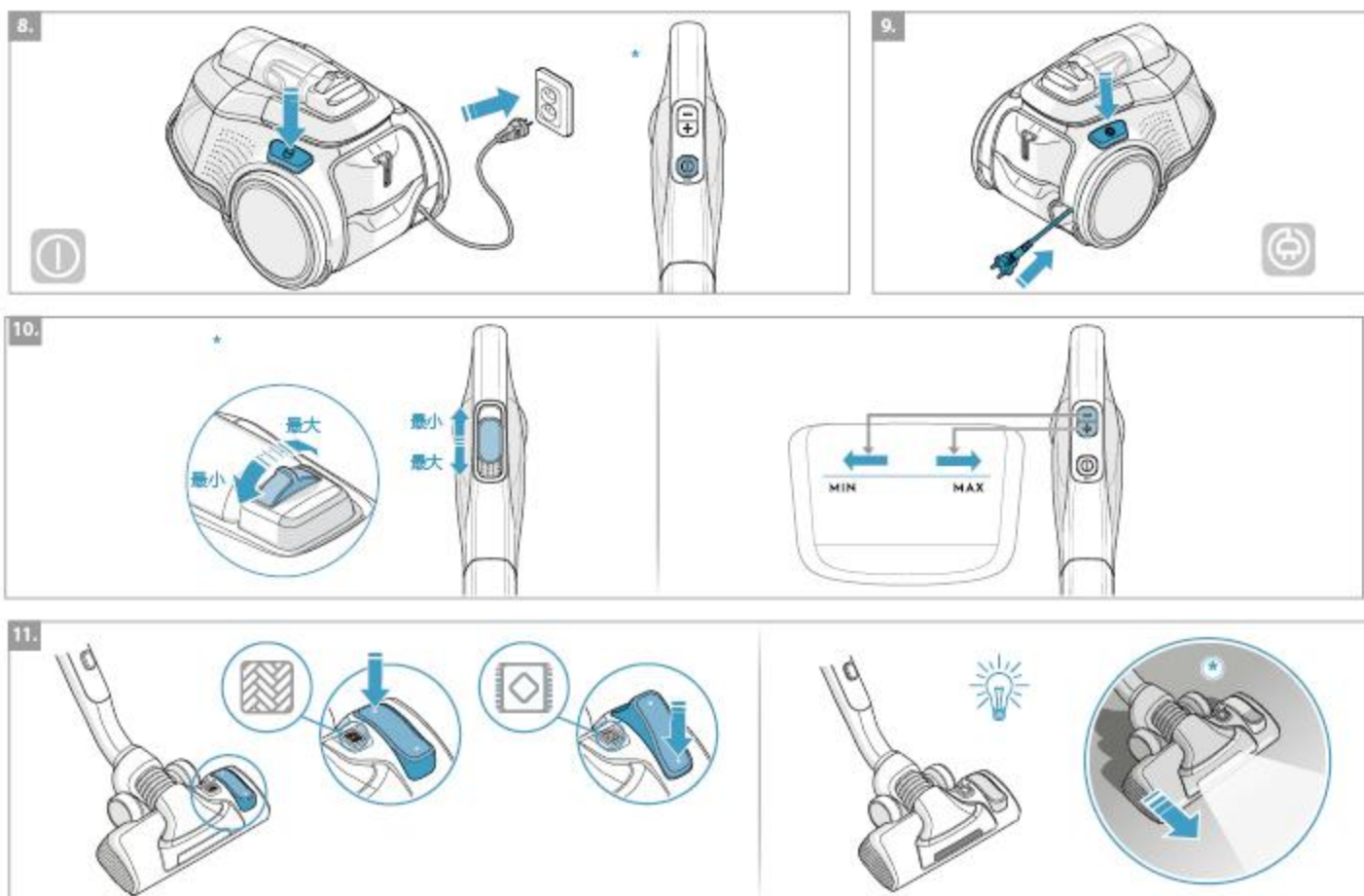

3. 使用产品

* 仅限特定机型

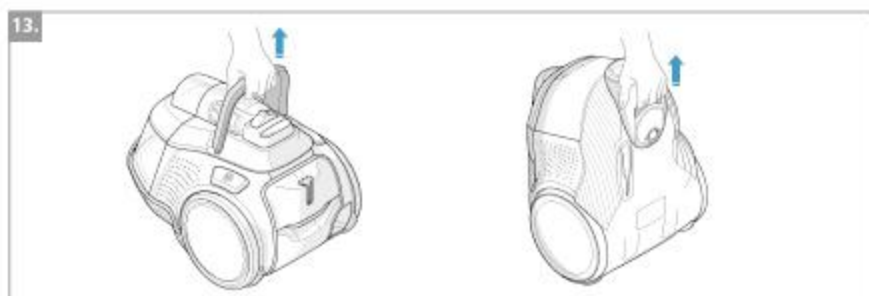

4. 清空灰尘

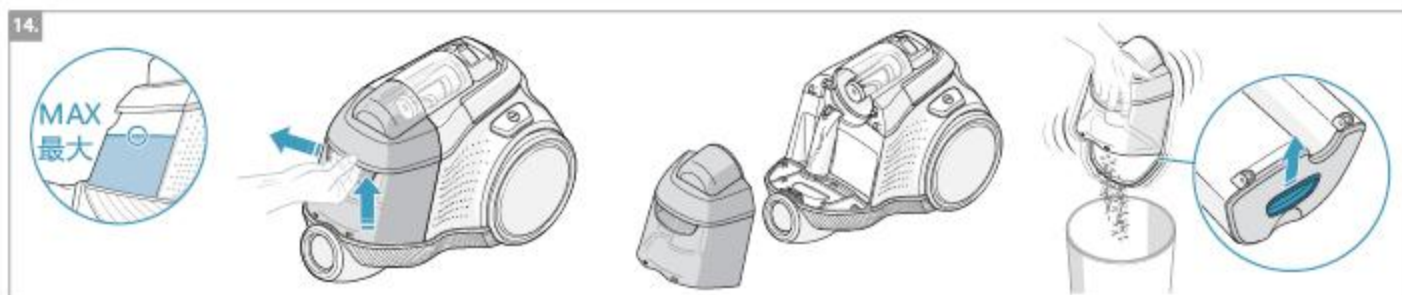

5. 清洗滤网

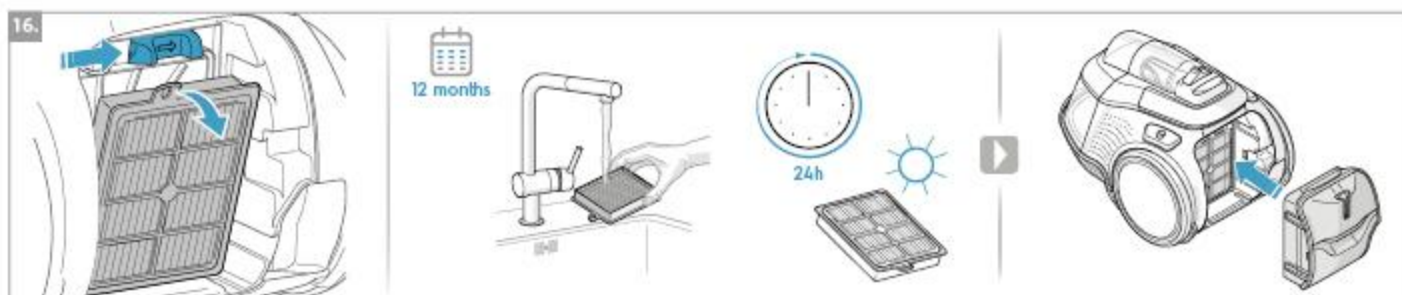
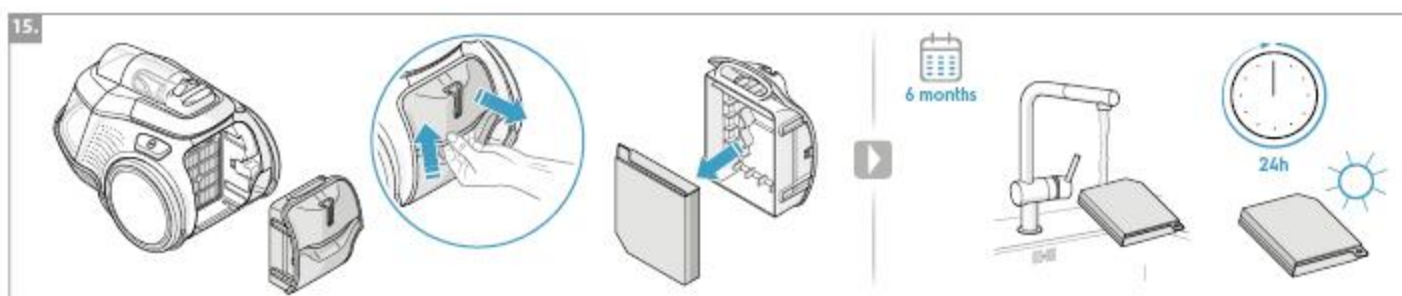

5 清洗滤网

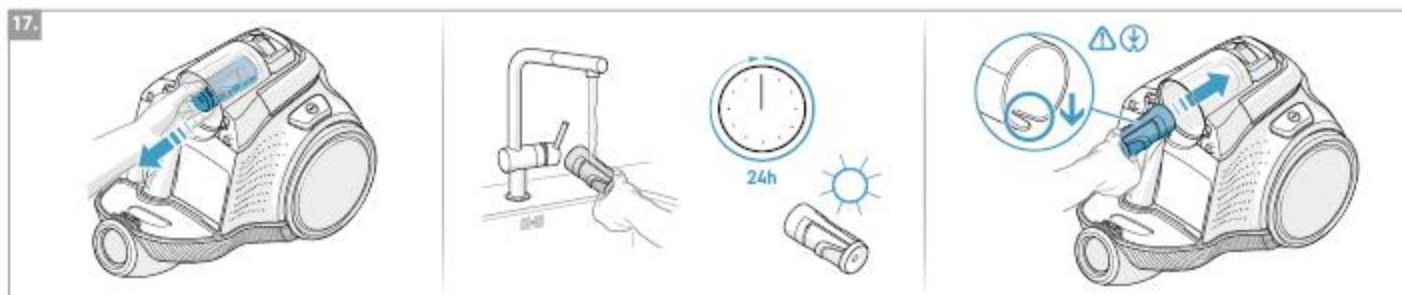

6. 维护

* 仅限特定机型



7. 系统检查

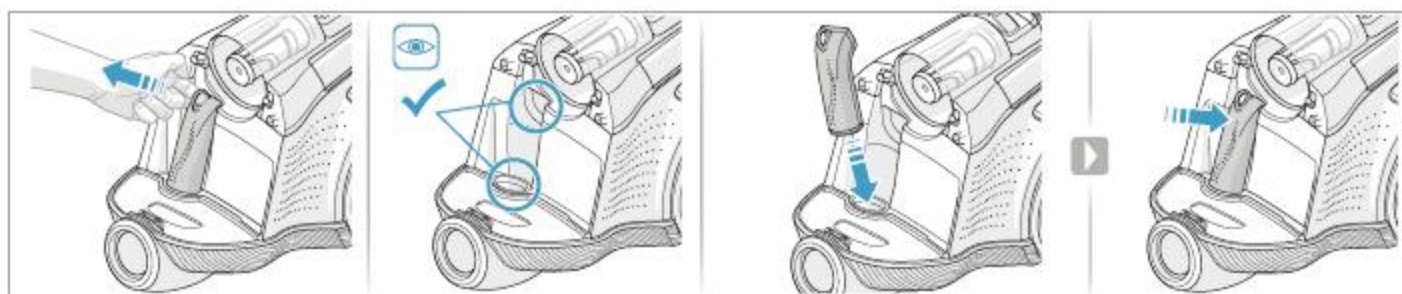
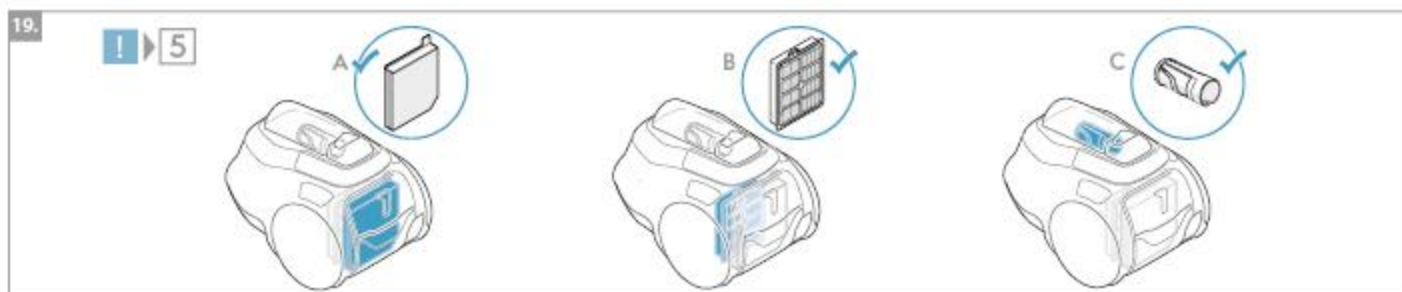

安全预防措施

本机不可由肢体伤残、感觉或精神障碍以及缺乏相关经验和知识的人员 (包括儿童) 使用, 除非有负责其安全的人员对其进行看管或指导, 并让他们了解相关危险。

儿童施加看管, 确保他们不将本器具作为玩具。

清洁和维护不应由儿童在无人监督的情况下完成。

警告: 涡轮吸头*带有可能导致其他小部件被卡住的旋转刷头。在使用它们时请务必谨慎, 并且仅在规定表面上使用。在取出被卡住的部件或清洁刷头之前, 首先请关闭吸尘器的电源。

丢弃本品之前, 请将电池从手柄遥控/LED亮灯吸头上取出**。

* 仅限特定机型。

** 有关如何取出电池的信息在第 6 节和第 7 节。

清洁或维护本器具时, 务必断开插头与主电源的连接。采用安全的方式处理电池。

如果电源线受损, 为了避免造成危险, 只能由获授权的 Electrolux 服务中心进行更换。

Pure C9 仅可用于室内和家庭环境中正常的吸尘。请将真空吸尘器存放在干燥的位置。

所有服务或维修都必须由获授权的 Electrolux 服务中心提供。请勿让儿童接触、塑料袋等包装材料, 以避免窒息。

切勿在以下情况下使用真空吸尘器:

潮湿区域。

靠近易燃气体等。

当产品显示明显损坏迹象时。

在锋利的物体或液体上。

当地板吸头显示明显损坏迹象时。

在热或冷的炭渣、未熄灭的烟蒂等污物上。

在细粉尘 (例如石膏粉、水泥、面粉)、热或冷灰烬上。

请勿将真空吸尘器置于阳光直射的环境下。

避免将真空吸尘器暴露在强热或冰冻温度下。

切勿在未安装滤网的情况下使用吸尘器。

当吸尘器启动且刷辊正在转动时, 切勿试图触摸刷辊。

当滚轮被卡住时。

如滤网损坏, 请勿使用真空吸尘器。

电源线预防措施

定期检查插头和电源线如果电源线损坏, 切勿使用吸尘器。

吸尘器电源线受损不在保修范围之内。

切勿通过电源线拉动或提起吸尘器。

在以上情况下使用真空吸尘器可能造成严重人身伤害或损坏产品。该等伤害或损坏不在 Electrolux 的保修范围内。

维修及保修

所有服务或维修都必须由获授权的 Electrolux 服务中心提供。

吸尘器电源线受损不在保修范围之内。因吸入液体、将器具浸没在液体中或使用带有受损软管和吸头的器具导致的电机损坏不在 Electrolux 的保修范围内。

弃置



产品上的此符号表示本产品包含电池, 不得与普通生活垃圾一起处理。



产品或其包装上的此标记表示该产品不能作为家庭垃圾处理。

为回收您的产品, 请将其带至官方的收集点或 Electrolux 服务中心, 以采用安全且专业的方式移除和回收电池和电器部件。依据您所在国家/地区的规定, 单独收集电子产品和可充电电池。

Electrolux Home Care and SDA 特此声明, 带有 FOR1、FOR2 及 FOR3 型无线电设备的真空吸尘器符合 2014/53/EU 指令。

感谢您选用 Electrolux Pure C9 真空吸尘器。为保证最佳使用效果，请始终使用原装配件和备件。本品设计以环保为准。所有塑料部件均有回收标志。

使用前指南

- 请仔细阅读并保留本手册。
- 检查是否包含所有描述的部件。
- 请特别注意安全预防措施！

PURE C9 真空吸尘器说明

- | | |
|---|--|
| <p>A. 显示屏 A1 旋钮控件* A2 遥控*</p> <p>B. 滤网盖</p> <p>C. 微尘过滤网</p> <p>D. 马达前置滤网</p> <p>E. 固定卡槽</p> <p>F. 电源线</p> <p>G. 手柄</p> <p>H. 旋风集尘盒和鼻锥滤网</p> <p>I. 风道</p> <p>J. 集尘盒</p> <p>L. AeroPro 软管</p> <p>M. AeroPro 手柄 M1 AeroPro Cassic 手柄* M2 AeroPro Ergo 手柄* M3 AeroPro 遥控手柄*</p> <p>N. AeroPro 伸缩管</p> <p>O. 固定夹</p> | <p>吸头配件</p> <p>K. AeroPro 三合一毛刷</p> <p>T. 电动吸嘴*</p> <p>U. FlowMotion 多功能地刷*</p> <p>V. FlowMotion LED 多功能地刷 (带前灯)*</p> <p>W. AeroPro 涡轮地刷*</p> <p>X. AeroPro 微型涡轮地刷*</p> <p>Y. ParkettoPro 硬地板刷*</p> <p>Z. AeroPro FlexProPlus 涡轮地刷*</p> <p>AA. AeroPro 长缝隙吸嘴*</p> <p>AB. BedPro 床用吸头*</p> <p>* 仅适用于部分机型</p> |
|---|--|

图片页面 2-6

如何使用这款真空吸尘器

- 1 使用真空吸尘器之前，检查所有滤网是否已安装到位。
- 2 将软管插入吸尘器（要取下软管，请按下锁定按钮并拉出软管）。将软管插入软管手柄，直至压扣咔嚓一声接合到位（按下压扣可松脱软管）。
- 3 将伸缩管与地刷相连。将伸缩管与软管手柄相连（要取下吸头，请按下锁定按钮并拉出吸头）。
- 4 要调节伸缩管，请单手按住锁定按钮，然后用另一只手牵拉手柄。

三合一毛刷

- 5 可将卡扣式支架和三合一毛刷固定在手柄下方，以便于取用。该工具有 3 种功能，参阅下一页图片。

更换电池*

- 6 带前灯的吸头*：首次使用前，移除保护膜（电池上方）。当前灯开始快速闪烁时，则需更换电池。请使用 2 节 AA 电池。
- 7 具备遥控功能的手柄*：当指示灯变红或按下任何按钮后均无反应时，请更换电池。仅可使用 CR1632 型号锂电池。

注意：丢弃之前，请将电池从产品中取出。请遵循您所在国家/地区收集电池和电子产品的规定。

启动/暂停真空吸尘器，并调节吸力

- 8 拉出电源线并将其插入主电源插座。按下开关按钮，打开或关闭吸尘器。带遥控器的型号也可通过手柄上的开关按钮操作。*
 - 9 吸尘工作完毕后，按下“收线”按钮可收回电源线。
 - 10 **调整吸力（手动控制机型）**：转动吸尘器上的旋钮或使用手柄上的气阀。*
- 调整吸力（遥控机型）**：按手柄上的“+/-”（增大/减小）按钮。显示器上的最小/最大及符号指示将显示功率。*

使用通用吸头吸尘（V*, W*）

- 11 使用踏板更换吸头设置。图标将显示推荐的地板类型（硬质地板或地毯）。
- FlowMotion LED 吸头***：向前移动吸头。数秒后，前灯自动亮起。不使用吸头数秒后，前灯自动熄灭。

固定位置，移动真空吸尘器

- 12 清洁时如需暂停片刻，可使用真空吸尘器后侧 (1) 的固定位置。使用真空吸尘器后侧底部 (2) 这款真空吸尘器有两个手提手柄。

清空集尘盒

- 14 集尘达到最大限度（“最大”标记）时，清空集尘盒。按压释放按钮，然后拉出集尘盒。将集尘盒放在垃圾桶上方。按下盖子下方的解锁按钮，向外旋转按钮，打开盖子。将灰尘倒入垃圾桶。按相反的顺序重新组装。

更换滤网

- 15 按下滤网按钮，打开滤网盖。使用 6 个月或当集尘明显可见时，清洗微尘过滤网。拉出框架上的标签，移除微尘过滤网。用自来水冲洗滤网。
注意：请勿使用清洁剂。待滤网完全干（至少在室温下放置 24 小时）后，再装回！
- 16 按下并滑动锁定装置至右侧，释放马达前置滤网。拉出滤框标签，移除滤网。使用十二个月后清洗预电机滤网。仅使用 Electrolux 推荐的原装滤网（请查阅耗材和配件）。在微温自来水下冲洗内部（脏污面）。轻拍滤框，去除水份。重复此过程四次。
注意：请勿使用清洁剂。避免触碰滤网表面。待滤网完全干（至少在室温下放置 24 小时）后，再装回！每年至少更换可冲洗滤网一次，或者在其变得很脏或者破损时进行更换。更换滤网后，将滤网盖推回，直至两个按钮咔嚓一声接合到位。
- 17 **清洗鼻锥滤网**：鼻锥滤网位于旋风集尘盒内部。如有灰尘进入，则需清洗鼻锥滤网。拉出鼻锥滤网。用手除去灰尘。如污染严重，可用自来水清洗。按相反的顺序重新组装。
注意：请勿使用清洁剂。待滤网完全干（至少在室温下放置 24 小时）后，再装回！

清洁通用地刷（V*, W**）和涡轮吸头（X*）

- 18 将通用地刷从伸缩管上卸下。用软管手柄清洁。将涡轮吸头从伸缩管上卸下，然后用剪刀减掉缠结的丝线等杂物。用软管手柄清洁吸头。*

使用 Pure C9，享用一次很棒的清洁体验！

Electrolux 保留变更产品、信息及规格的权利，恕不预先通知。

| 吸头/配件 | 用于: | 吸头/配件 | 用于: |
|--|---|--|--|
| T. 电动吸嘴*  | 地毯吸头: - 电动吸嘴可通过旋转刷辊拍打地毯, 从而达到最佳的吸尘效果, 深度清洁地毯。 - 启动刷辊后, 不要让电动吸嘴呆在一个位置静止不动。 | U. FlowMotion 地刷* V. FlowMotion LED 地刷*  | 通用吸头: - 适合所有地板类型, 确保在地毯和硬质地板上的最佳除尘效果。 - 使用踏板更换吸头设置。图标将显示建议的地板类型。 - 前灯有助于发现暗处 (家具下方等位置) 的灰尘和污垢。仅限 PureVision 吸头 |
| W. 涡轮地刷*  | 地毯: - 同时使用刷子和真空装置 (清理毛发、纤维等的理想工具)。 - 滚筒刷由真空吸尘器的气流驱动。 - 不适合长绒和长毛边地毯以及垫或防水地毯等防滑地毯。请用通用吸头代替。 | X. 微型涡轮吸头*  | 室内装潢织物: - 同时使用刷子和真空装置 (清理毛发、纤维等的理想工具)。 - 适合布艺家具、汽车座椅、床垫等。 - 滚筒刷由真空吸尘器的气流驱动。 - 不适合长绒和长毛边地毯, 因为长绒或长边会卷入旋转刷辊中。 |
| Y. ParkettoPro 吸头*  | 硬质地板: - 用于温和清洁硬质地板 (镶木地板、木地板、瓷砖等)。 - 确保带缝硬质地板的最佳除尘效果。 | Z. FlexProPlus 地刷*  | 硬质地板: - 用于清洁家具、角落及其他障碍物下方/之间的灰尘。 - 可轻松旋转 180°, 伸入狭窄空间。 |
| AA. 长缝吸头*  | 加长工具: - 适合难以到达的区域 (书架顶端等)。 - 适合狭窄空间 (暖气片背后、汽车座椅底部等) | AB. BedPro 吸头*  | 床用吸头: - 可吸除寝具和床垫上的污垢及尘螨。 |
| K. 三合一毛刷*  | | | 三合一毛刷: 1. 适用于硬质表面 (书架、踢脚板等) 除尘工具。 2. 适用于纺织品 (窗帘、装饰等) 清洁工具。 3. 适用于狭窄空间 (暖气片背后等) 清理工具。 |

手动功率调节模式

— 根据吸尘器上的图形, 获取最佳性能。

故障排除

| 问题 | 解决方案 |
|-------------|--|
| 真空吸尘器无法启动 | <ul style="list-style-type: none"> • 检查电缆是否接通电源。 • 检查插头和电缆是否受损。 • 检查保险丝是否熔断。 • 检查遥控手柄上的电池指示灯是否响应 (仅限于特定机型)。 |
| 吸尘器停止工作 | 吸尘器可能过热: 断开电源; 检查吸头、管道、软管或滤网是否堵塞。让吸尘器冷却 120 分钟, 然后再插入电源。 如吸尘器仍不工作, 请联系经授权的 Electrolux 服务中心。 |
| 吸力低于正常水平 | <ul style="list-style-type: none"> • 检查集尘盒是否装满或堵塞。 • 检查风道及进出口连接是否堵塞, 是否需要清理。 • 检查前预电机滤网是否堵塞, 是否需要更换。 • 检查吸头是否堵塞, 是否需要清理。 • 轻轻挤压软管, 检查是否被堵塞。但是, 当玻璃或针卡在软管中造成阻塞时, 要小心处理。 注意: 因清洗所致的软管受损不在保修范围内。 |
| 一旦水被吸入真空吸尘器 | 将需要在经授权的 Electrolux 服务中心更换电机。 因进水引起的电机受损不在保修范围内。 |

如有任何其他问题, 请联系经授权的 Electrolux 服务中心。

耗材及配件



购买适合您器具的耗材及配件：

中国大陆微信公众号：伊莱克斯小家电体验中心



各国家和地区的耗材及配件可用性各不相同。
请参阅我们当地的 Electrolux 网站，了解更多详情或联系当地客户服务热线寻求支持。

S-FILTER 滤网



PureAdvantage D11 可洗
(澳大利亚, 新西兰)

HEPA 13 可洗

S-FRESH 香氛包



Crispy Bamboo
Tropical Breeze
Brown Sugar & Fig
Evening Rose
Citrus Burst

吸头*



Silent Parketto 吸头



DustMagnet Silent 吸头

套件



精致护理套件



清洁及整理套件

* 配件可用性取决于伸缩管尺寸

客户关怀及服务

在联系售后服务时，确保您有以下可用的数据：

- 型号
- PNC 号
- 序列号

产品铭牌上可找到该等信息。

产品标准：GB4706.1-2005, GB4706.7-2004,
GB4343.1-2018, GB17625.1-2012

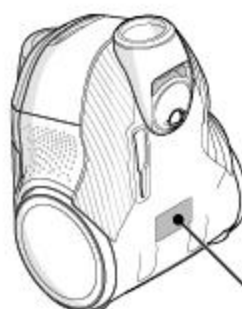

| 型号 | PNC 号 | 序列号 |
|--|---------------------|------------------------|
| Electrolux | | |
| Model Code TBD | PNC 910287894 | Type FNA |
| | Et 00 | Serial No. 12345678 |
| | 230 V ~ 50 Hz | 550 W NCM |
| Electrolux Appliance AB S-1 Gönarvagen 140 S-611 05 40 Stockholm, Sweden | | |

请访问我们的网站：



获取使用建议、宣传手册、
故障检修员联系方式、服务信息：
www.electrolux.com

1. 產品概覽

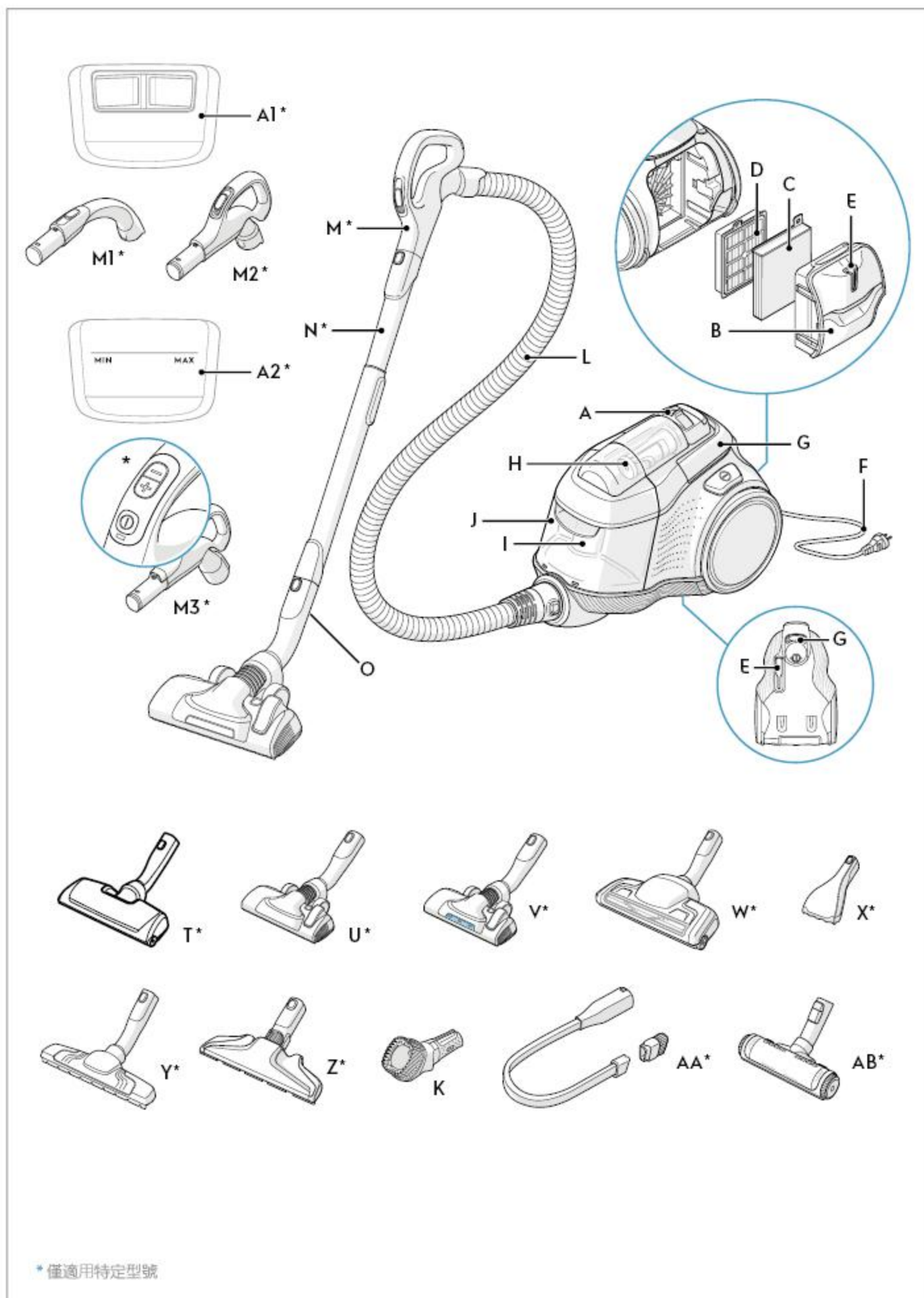

2. 安裝

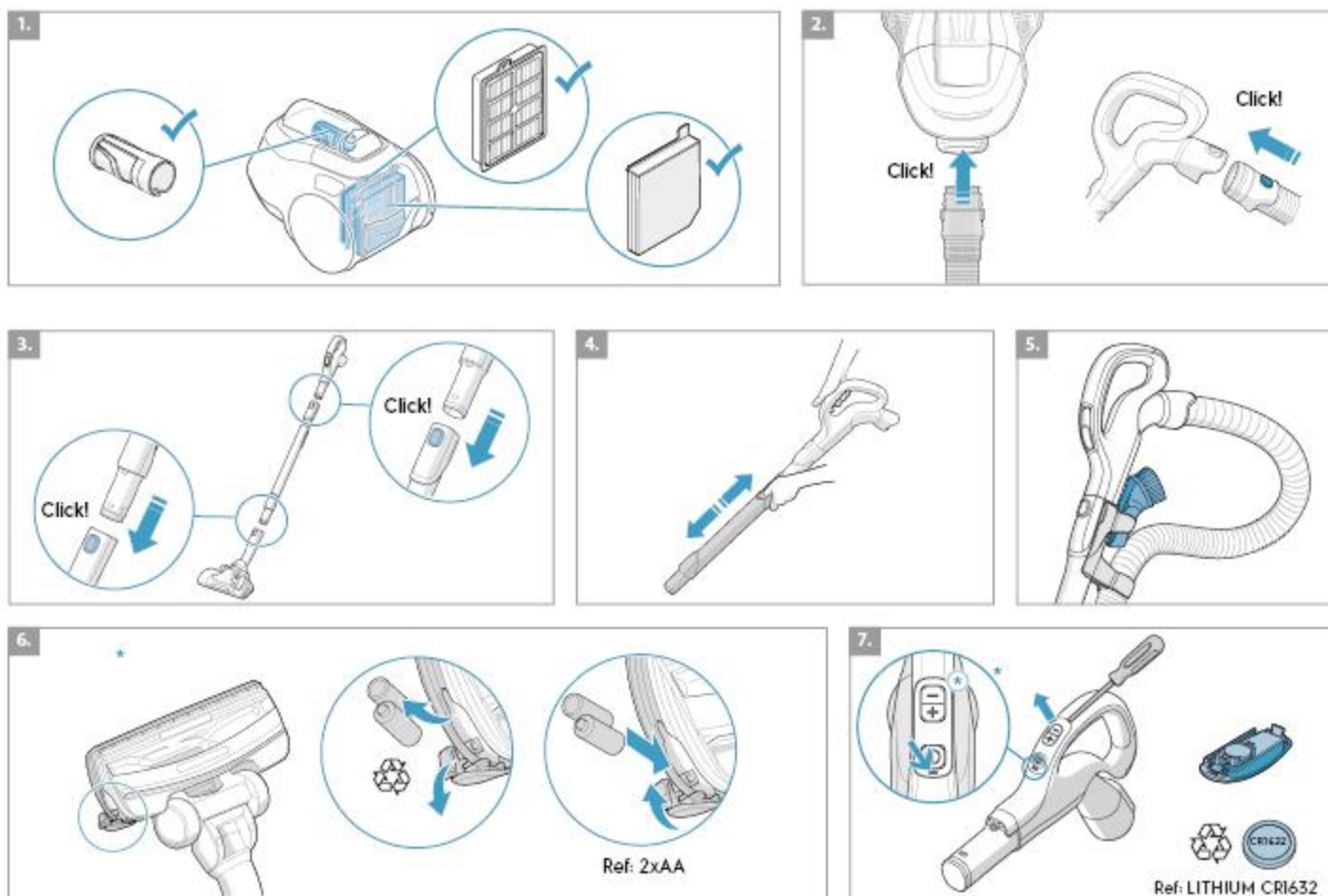

3. 使用本產品

* 僅適用特定型號

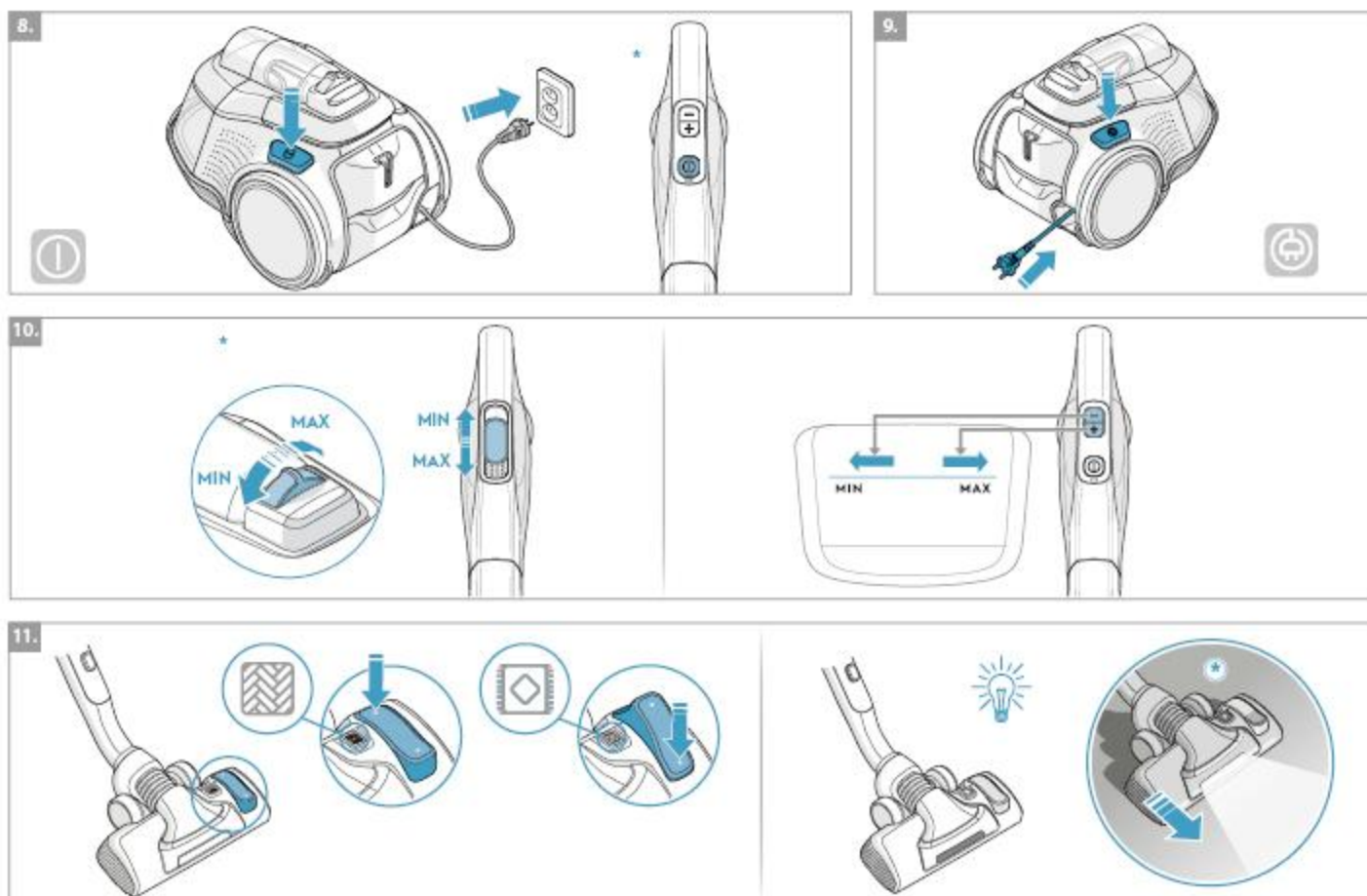

3. 使用本產品

* 僅適用特定型號

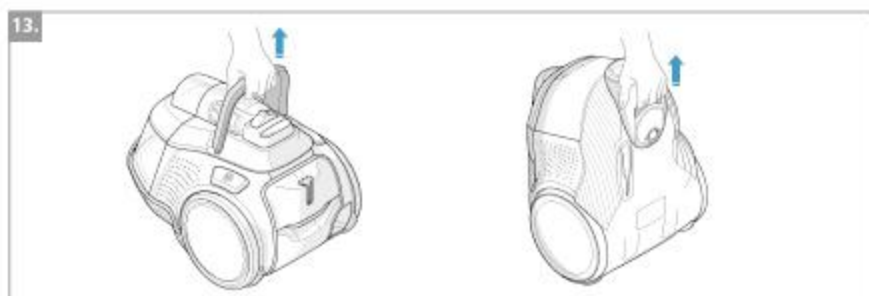

4. 清空灰塵

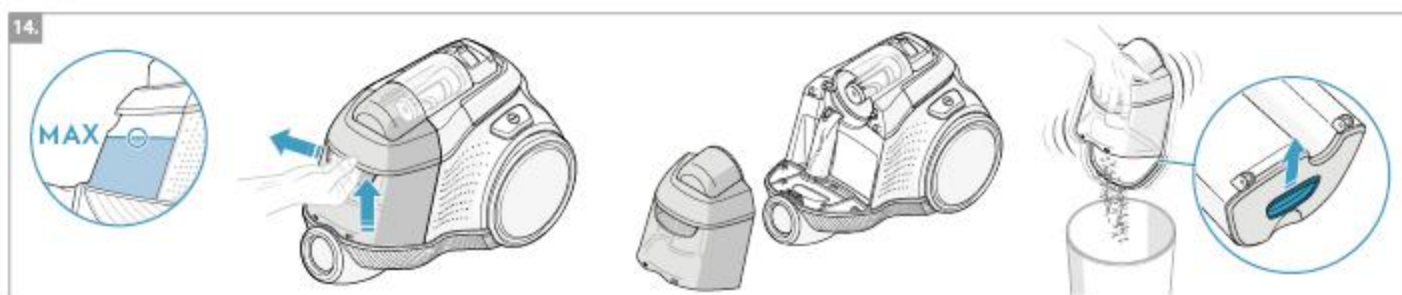

5. 清潔濾網

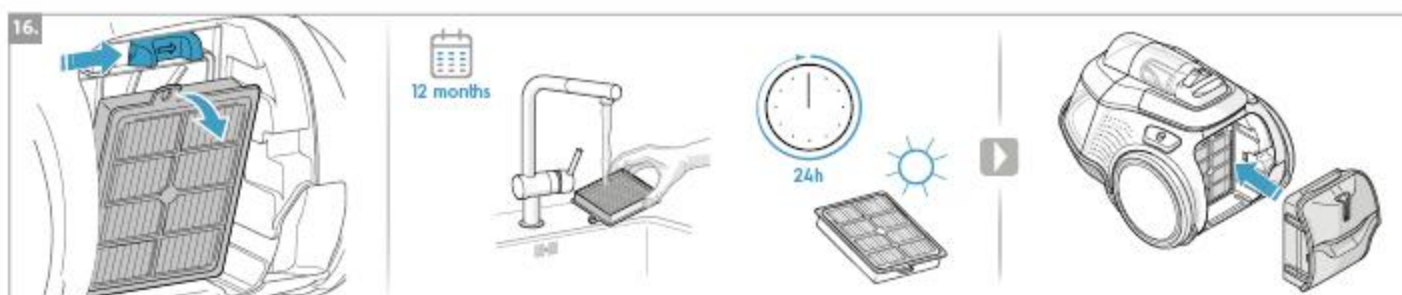
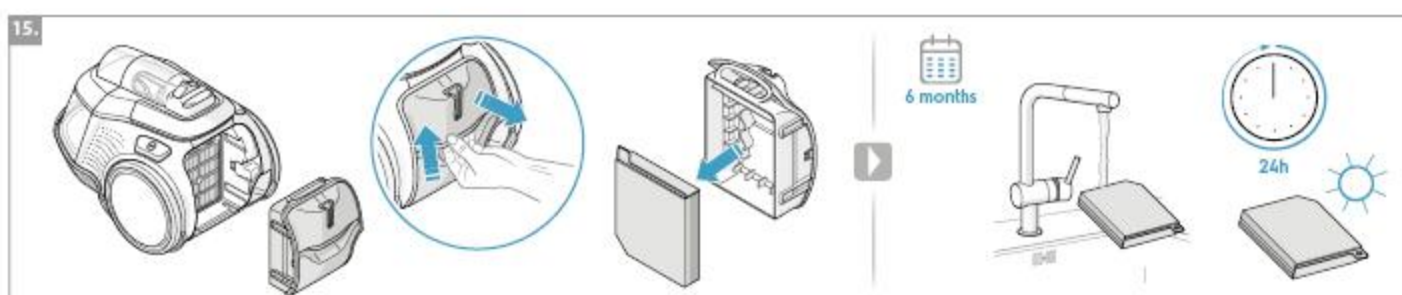

5 清潔濾網

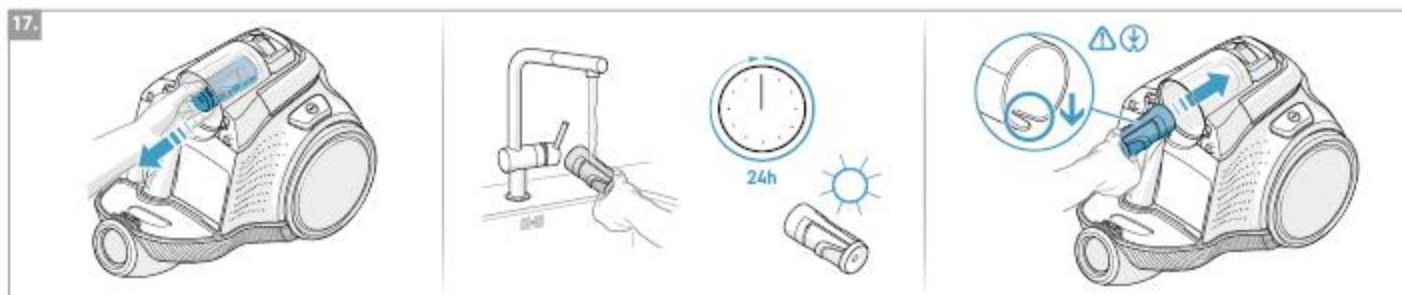

6. 維護

* 僅適用特定型號



7. 系統檢查

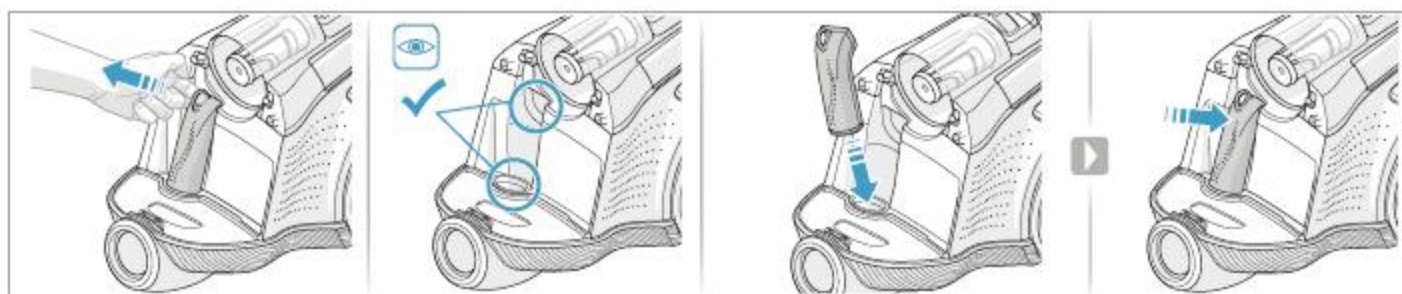
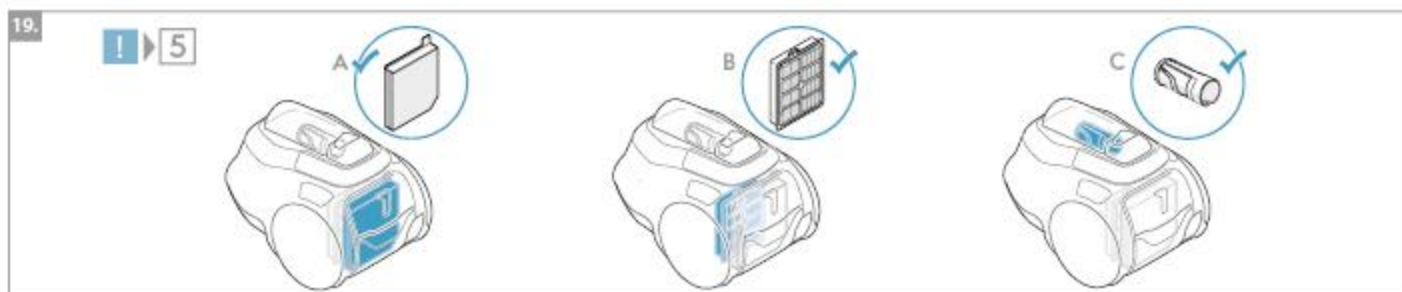

安全警告

本設備可供 8 歲以上的兒童，以及在身體、感官或智力方面存在障礙，或缺乏經驗和知識的人員使用，但必須對他們加以監護或給予安全使用設備的指導，並讓他們瞭解相關危險。

注意看管兒童，確保他們不玩弄本產品。

不得在無人監管的情況下，讓兒童清潔和維護本產品。

警告：渦輪吸頭*有一個旋轉刷頭，小部件可能被卡在其中。請小心使用，且僅用於規定的表面。在取出被卡住的小部件或清潔刷頭之前，請先關閉吸塵器的電源。

廢棄本產品前，必須將電池從手柄*/帶 LED 燈的吸頭*內的遙控器中取出**。

*僅適用特定型號

** 關於如何取出電池的資訊參見第 6、7 條。

清潔或維護本產品前或取出電池時，務必斷開插頭與主電源的連接。必須安全處理電池。

如果電源線受損，必須由授權的伊萊克斯服務中心更換，以避免危險。

Pure C9 應僅限用於家庭環境中的一般室內吸塵請確保將吸塵器存放在乾燥位置。

所有維護或維修都必須由伊萊克斯授權服務中心進行。

塑料袋等包裝材料應放在兒童接觸不到的地方，以避免造成兒童窒息。

切勿在下列情況下使用吸塵器：

在潮濕的地方。

靠近易燃氣體等。

當本產品有明顯的損壞痕跡時。

存在鋒利物體或液體。

當清潔地板吸頭有明顯的損壞痕跡時。

存在熱或冷的炭渣、未熄滅的煙蒂等物品等。

存在細末粉塵（例如石膏粉、水泥、麵粉、熱或冷的灰燼）

請勿將吸塵器放在陽光直射到的地方。

避免吸塵器暴露在高溫或冰凍溫度下。

切勿在未安裝濾網的情況下使用吸塵器。

吸塵器開啟、滾筒刷轉動時請勿觸碰滾筒刷。

滾筒被堵塞時。

如果濾網損壞或破損，請勿使用吸塵器。

電源線防範措施

定期檢查插頭和電源線。如果插頭或電源線損壞，切勿使用吸塵器。

吸塵器電源線受損不在保固範圍之內。

切勿用電源線拉扯或提起吸塵器。

在上述情況下使用吸塵器可能會造成嚴重的人身傷害或產品損壞。上述傷害或損壞不在保固範圍之內，伊萊克斯亦不負責。

注意：軟管帶有電氣連接

- 不可用來吸水；

- 不可浸入水中清潔；

- 此管必須定期檢查，若有損傷就不可再使用。

維護和保固

所有維護或維修都必須由獲授權的伊萊克斯服務中心進行。

吸塵器電源線受損不在保固範圍之內。

吸取液體、將本產品浸入液體內或在軟管和吸頭損壞的情況下使用本產品所造成的馬達損壞不在保固範圍之內。

處理



產品上有此標誌，表示本產品內有電池，不得將電池與一般生活垃圾一起處理。



產品或包裝上有此標誌，表示不得將產品作為生活垃圾處理。欲循環利用產品，請將其送交安全、專業地取出和回收利用電池和電氣部件的官方回收處或伊萊克斯服務中心。請遵循您所在國家的電氣產品和充電電池分類收集規則。

Electrolux Home Care & SDA 茲聲明，配有無線電控制設備的真空吸塵器型號 FOR1、FOR2 和 FOR3 符合 2014/53/EU 指令。

感謝您選擇伊萊克斯 Pure C9 真空吸塵器。務必使用原裝配件和備件以達到最佳使用效果。本產品設計心繫環保理念。所有塑膠部件均已標識以便於回收。

開始使用前

- 請仔細閱讀本手冊。
- 核查所述的所有部件是否齊備。
- 特別注意安全警告！

PURE C9 吸塵器說明

| A. 顯示螢幕 | 吸頭配件 |
|--------------------------|--------------------------------|
| A1 個旋鈕控制器* | K. AeroPro 三合一工具 |
| A2 個遙控器* | T. 電動吸嘴* |
| B. 濾網蓋 | U. FlowMotion 吸頭* |
| C. 細塵濾網 | V. FlowMotion LED 吸頭 (帶前燈)* |
| D. 馬達前置濾網 | W. AeroPro 渦輪吸頭* |
| E. 固定槽 | X. AeroPro 小型渦輪吸頭* |
| F. 電源線 | Y. ParkettoPro 吸頭* |
| G. 提手 | Z. AeroPro FlexProPlus 吸頭* |
| H. 氣旋倉和鼻錐濾網 | AA. AeroPro 長縫隙吸頭* |
| I. 風道 | AB. BedPro 吸頭* |
| J. 集塵盒 | |
| L. AeroPro 軟管 | |
| M. AeroPro 手柄 | |
| M1 個 AeroPro Classic 手柄* | *僅適用選定型號 |
| M2 個 AeroPro Ergo 手柄* | |
| M3 個 AeroPro 遙控手柄* | |
| N. AeroPro 伸縮管 | |
| O. 固定夾 | |

圖片頁 2-6

如何使用真空吸塵器？

- 1 使用真空吸塵器前檢查所有濾網是否固定到位。
- 2 將軟管插入吸塵器（欲卸下軟管，可按 [Lock] 按鈕，然後拉出軟管）。將軟管插入軟管手柄，直至 [Lock] 按鈕啣合一聲鎖上（欲卸下軟管，可按 [Lock] 按鈕，然後拉出軟管）。
- 3 將伸縮管接到吸頭上。將伸縮管接到軟管手柄上（欲卸下伸縮管，可按 [Lock] 按鈕，然後拉出伸縮管）。
- 4 用一隻手握住鎖定器，用另一隻手拉動手柄來調節伸縮管。

三合一配套工具

- 5 您可以將夾具和三合一工具固定在手柄下，使其易於取用。該工具有三個功能，參見下一頁圖片。

更換電池*

- 6 帶前燈的吸頭*：首次使用前要移除（電池上方的）保護膜。前燈開始閃爍時要換電池。使用兩節 AA 電池。
- 7 帶遙控手柄*：指示燈變紅或按任何按鈕都沒有反應時要更換電池。僅使用 CR 1632 型鋰電池。
注意：廢棄本產品前要取出電池。遵循您所在國家的電池和電氣產品收集規則而行。

開啟/關閉吸塵器，然後調節吸力。

- 8 拉出電源線，將其插入主電源。按 [ON/OFF] 按鈕以開啟/關閉吸塵器。對於帶遙控型號，也可用手柄上的 [ON/OFF] 按鈕操作。
- 9 清潔後，按 [REWIND] 按鈕繞回電線。
- 10 調節吸力（手控模式）：轉動吸塵器上的旋鈕或使用手柄上的氣閘。調節吸力（遙控模式）：按手柄上的 [+/-] 按鈕。顯示螢幕上的 [MIN/MAX] 和標誌指示燈會顯示吸力大小。*

用通用吸頭(V*、W*)吸塵

- 11 用踏板更改吸頭設置。圖標所示為推薦的地板類型。（硬地板或地毯）。
RowMotion LED 吸頭*：向前移動吸頭。幾秒鐘後，前燈會自動開啟。吸頭停用時，前燈會在幾秒鐘後自動關閉。

固定位置，移動真空吸塵器。

- 12 吸塵過程中暫停時，使用吸塵器背面的固定位置 (1)。
搬運和存放吸塵器時，使用吸塵器底部的固定位置 (2)。
- 13 吸塵器有兩個提手。

清空集塵盒。

- 1 灰塵量達到上限（[MAX] 標誌）時要清空集塵盒。按 [RELEASE] 按鈕，然後拉動取出集塵盒。將集塵盒置於垃圾桶上方。按蓋子下的 [UNLOCK] 按鈕，向外轉動打開蓋子。傾倒灰塵至垃圾桶內。逆序重新裝好。

更換濾網

- 2 拉動 [FILTER] 按鈕以打開濾網蓋。使用半年後或能看到灰塵時要清潔細塵濾網。拉動濾網框上的拉片以取出細塵濾網。在自來水下沖洗濾網。注意：請勿使用清潔劑。讓濾網完全風乾（室溫下最少 24 小時）後再裝回！
- 3 按壓並向右推動鎖定機關以鬆開馬達前置濾網。拉動濾網框上的拉片，取出濾網。使用一年後要清潔馬達前置濾網。只使用伊萊克斯推薦的原裝 S-Filter 濾網（參見「耗材和配件」）。在溫熱的自來水中清洗濾網內面（鏽污的一面）。拍打濾網框以去除濾網上的水。重複以上過程四次。
注意：請勿使用清潔劑。避免觸碰濾網表面。讓濾網完全風乾（室溫下最少 24 小時）後再裝回！要每年至少更換一次可水洗濾網，或在濾網很髒或破損時要更換濾網。
更換濾網後，關上濾網蓋，直至咔嚓一聲復歸原位。
- 4 清潔鼻錐濾網：鼻錐濾網位於氣旋倉內。進灰塵時要清理鼻錐。拉出鼻錐以清除灰塵。用手清除灰土。如果泥垢很多，要在自來水下清洗。逆序重新裝好。
注意：請勿使用清潔劑。讓濾網完全風乾（室溫下最少 24 小時）後再裝回！









清潔通用濾嘴 (V*、W**) 和渦輪濾嘴 (X*)

- 5 將通用吸頭與伸縮管分開。用軟管手柄清潔。
將渦輪吸頭與伸縮管分開，用剪刀剪斷纏在一起的線頭，然後將其清除掉。用軟管手柄清潔吸頭。*

享受 Pure C9 帶來的絕佳清潔體驗！

伊萊克斯保留不經事先通知而更改產品、資訊和規格的權利。

關於如何達致最佳效果的小貼示

| 吸頭 / 配件 | 用於: | 吸頭 / 配件 | 用於: |
|--|---|--|--|
| T. 電動吸嘴*  | 清潔地毯吸頭: - 電動吸嘴可透過旋轉式滾刷來擾動地毯, 能發揮最佳集塵和深度清潔地毯的效能。 - 開啟滾刷時, 請勿讓電動吸嘴處於靜止狀態。 | U. FlowMotion 吸頭* V. FlowMotion LED 吸頭*  | 通用吸頭: - 用於各類地板, 在地毯和硬地板上均能確保最佳吸塵效果。 - 用踏板更改吸頭設置。圖標所示為推薦的地板類型。 - 前燈有助於查看陰暗地方 (家具底下等) 的塵垢。僅限 PureVision |
| W. 渦輪吸頭*  | 清潔地毯吸頭: - 同時清刷和吸塵 (吸取毛髮、纖維等效果最佳)。 - 滾筒刷由真空吸塵器氣流驅動。 - 不適用於有很長毛絨和長流蘇的地毯、防滑地毯如門墊或防水地毯。可改用通用吸頭。 | X. 小型渦輪吸頭*  | 清潔墊套吸頭 - 同時清刷和吸塵 (吸取毛髮、纖維等效果最佳)。 - 用於紡織品家具、汽車座椅、床墊等。 - 滾筒刷由真空吸塵器氣流驅動。 - 不適用於有很長毛絨和長流蘇的地毯, 因為會卡在旋轉的滾筒刷中。 |
| Y. ParkettoPro 吸頭*  | 清潔硬地板吸頭: - 用於柔和清潔硬地板 (鑲木地板、木地板、瓷磚等)。 - 在有縫隙的硬地板上吸塵效果最佳。 | Z. FlexProPlus 吸頭*  | 清潔硬地板吸頭: - 用於清潔家具、角落和其他障礙物下方/之間。 - 可以輕易地旋轉 180 度, 直接進入狹窄的空間。 |
| AA. 清潔長縫隙吸頭*  | 加長工具: - 用於難以觸及的地方 (架子頂部等)。 - 用於狹窄的空間 (散熱器後面、汽車座椅下面等)。 | AB. BedPro 吸頭*  | 清潔床鋪吸頭: - 清除寢具和床墊上的灰塵和塵蟎。 |
| | | K. 三合一配套工具*  | 三合一工具: 1. 用於硬表面 (書架、滑板等) 的吸塵工具。 2. 用於紡織品 (窗簾、墊套等) 的墊套清潔工具。 3. 用於狹窄空間 (散熱器背後等) 的縫隙清潔工具。 |
| 可手動調節吸力的型號。 - 依循吸塵器上的圖示操作, 以達到最佳性能。 | | | |

故障檢修

| 問題 | 解決方案 |
|---------------------------|--|
| 吸塵器不啟動 | <ul style="list-style-type: none"> 檢查電線是否連接至電源。 檢查插頭和電線是否破損。 檢查保險絲是否熔斷。 檢查遙控手柄中的電池指示燈是否有反應 (僅適用特定型號)。 |
| 吸塵器停止運轉 | 可能是吸塵器過熱: 斷開主電源連接; 檢查吸頭、伸縮管、軟管或濾網是否堵塞。吸塵器冷卻 120 分鐘後再連接電源。 如吸塵器仍無法使用, 請聯絡授權的伊萊克斯服務中心。 |
| 吸力異常下降 | <ul style="list-style-type: none"> 檢查集塵盒是否已滿或堵塞。 檢查風道和進風口或出風口連接部位是否堵塞、需要清理。 檢查馬達前置濾網是否堵塞、需要更換。 檢查吸頭是否堵塞、需要清理。 用輕輕「推擠」的方式檢查軟管是否堵塞。但是, 如果阻塞是由軟管內的玻璃或針狀物體引起的, 請務必多加小心。 注意: 對於因清潔軟管而導致的任何損壞, 均不在保固範圍之內。 |
| 真空吸塵器進水 | 必須送至授權的伊萊克斯服務中心更換馬達。 因進水而導致的馬達損壞不在保固範圍之內。 |
| 如有任何其他問題, 請聯絡授權的伊萊克斯服務中心。 | |

耗材和配件



購買吸塵器
耗材和配件。

www.electroluxshop.co.kr
<https://shop.electrolux.com.au/>

耗材和配件的供應情況因地區和國家而異。
請參閱當地的伊萊克斯網站以瞭解更多詳情，或聯絡當地的伊萊克斯客服熱線以尋求支持。

S-FILTER



PureAdvantage D11 可水洗
(澳洲, 紐西蘭)

HEPA 13 可水洗

S-FRESH



Crispy Bamboo
Tropical Breeze
Brown Sugar & Fig
Evening Rose
Citrus Burst

吸頭*



Silent Parketto



DustMagnet Silent

配件



Delicate Care KIT



Clean & Tidy KIT

* 配件供應情況取決於伸縮管尺寸

客戶服務

聯絡客服時，請確保提供以下資料。

- 型號
- PNC 編號
- 系列號

上述資料載於額定功率牌上。

有鑒於世界各國對綠色環保意識的重視，
伊萊克斯依循 RoHS 「危害性限制物質指令」
誠實標示產品化學物質含量，
關於本產品的 RoHS 聲明書，
請上伊萊克斯官網->「支援服務」->「RoHS 聲明書」，
依產品類別及型號檢索。

<http://www.electrolux.com.tw/Support/Customer-Care/>

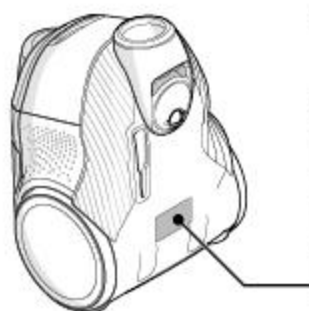

| 型號 | PNC 編號 | 系列號 |
|---|---------------------|------------------------|
| Electrolux | | |
| Model Code TBD | PNC 910287894 | Type FNA |
| | Et 00 | Serial No. 12345678 |
| | 230 V ~ 50 Hz | 550 W NCM |
| | CE | RoHS (EU) |
| Electrolux Appliance AB S-1 Gönaragatan 140 SE-105 40 Stockholm, Sweden | | |

請造訪我們的網站以：



獲取使用建議、小冊子、
故障檢修指南、服務資訊。
www.electrolux.com

1 제품 개요

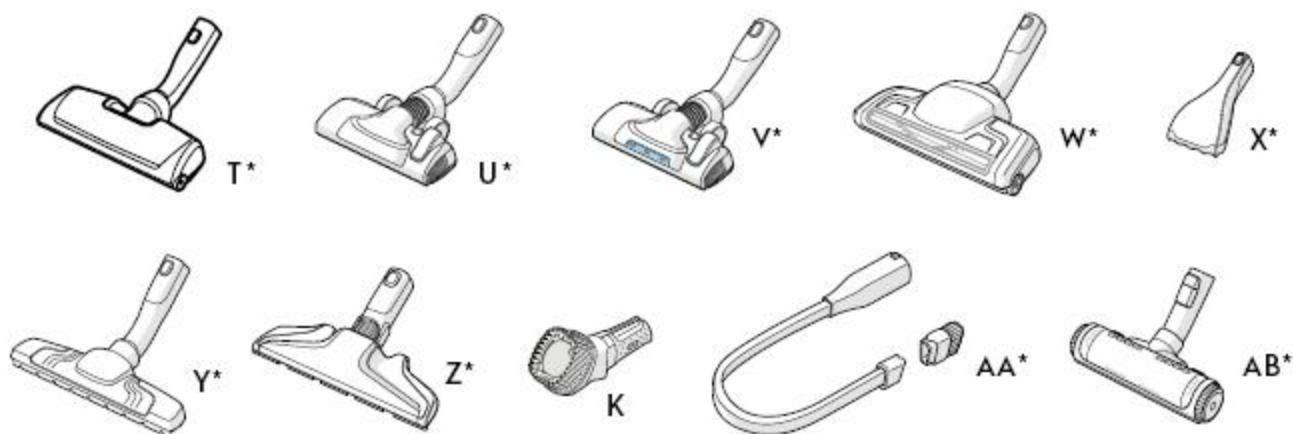
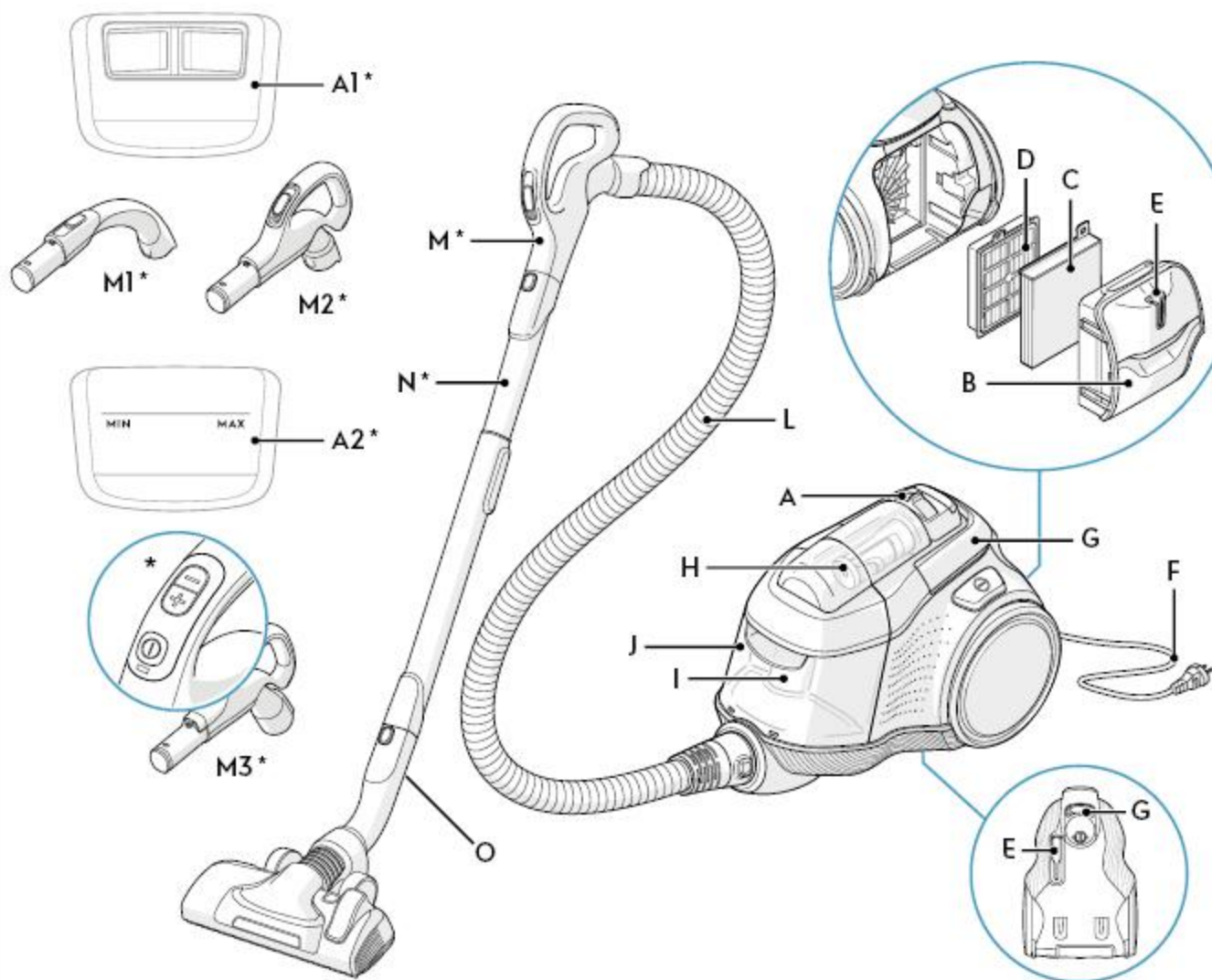

* 특정 모델만 해당

2 설치

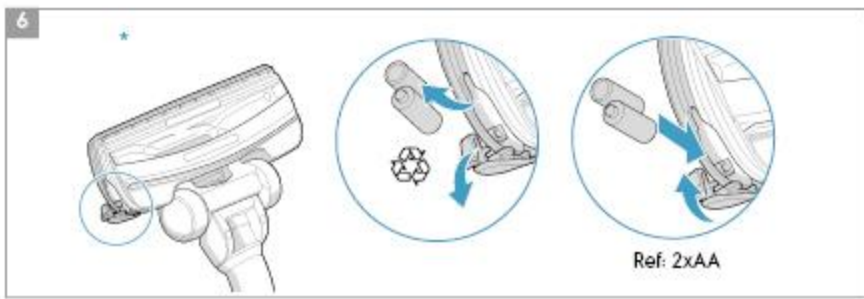
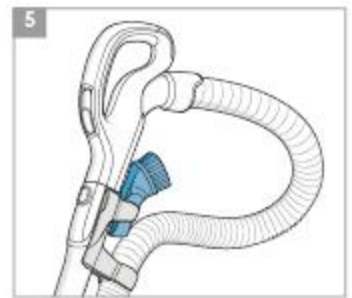
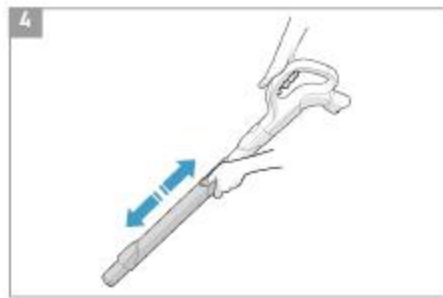
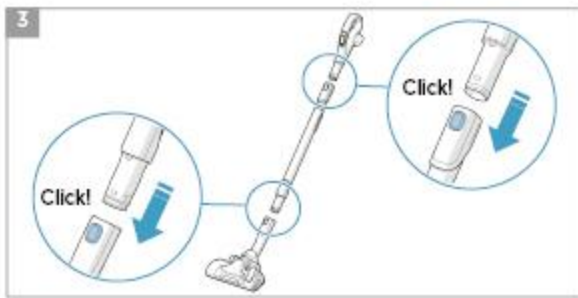
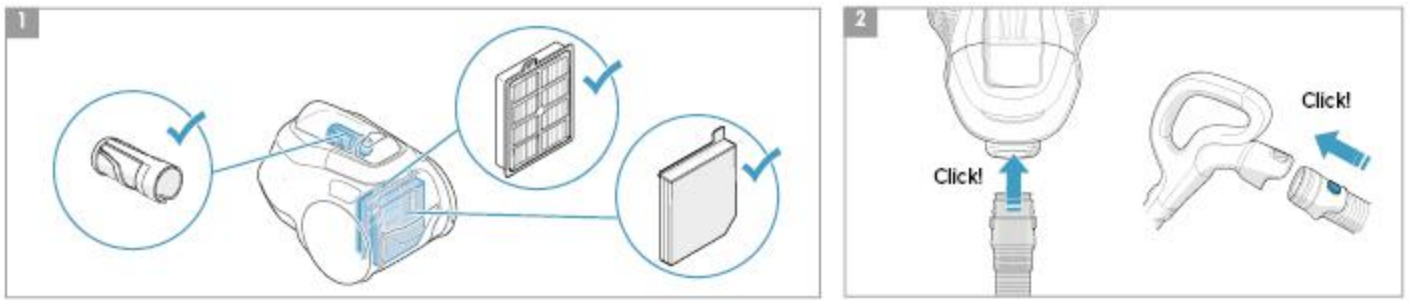

3 제품 사용

* 특정 모델만 해당

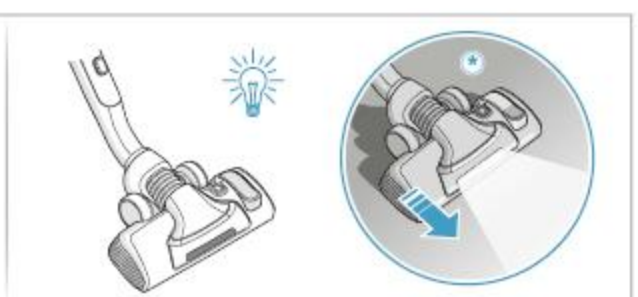
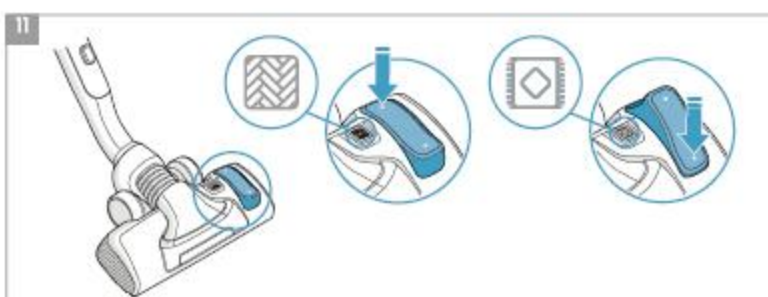
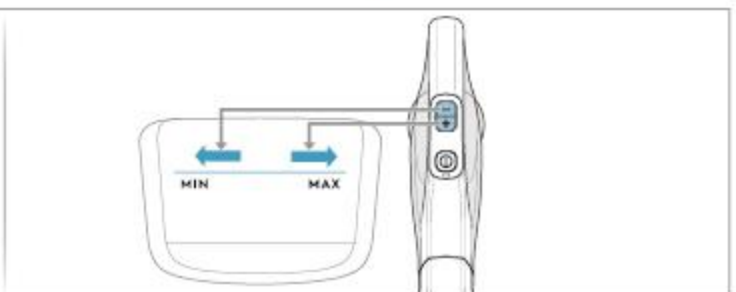
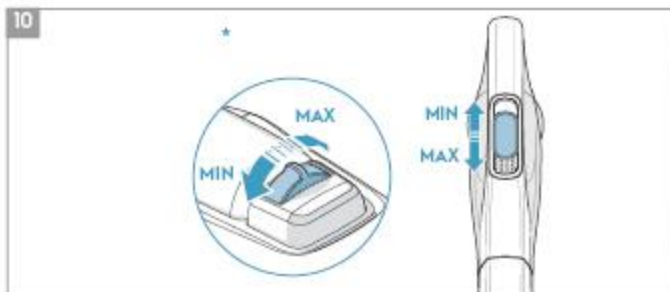
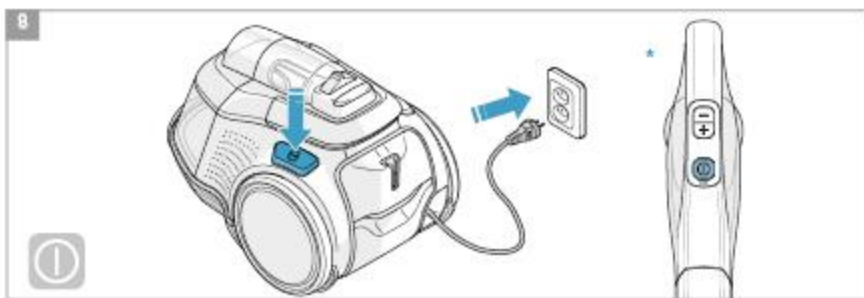

3 제품 사용

• 특정 모델만 해당

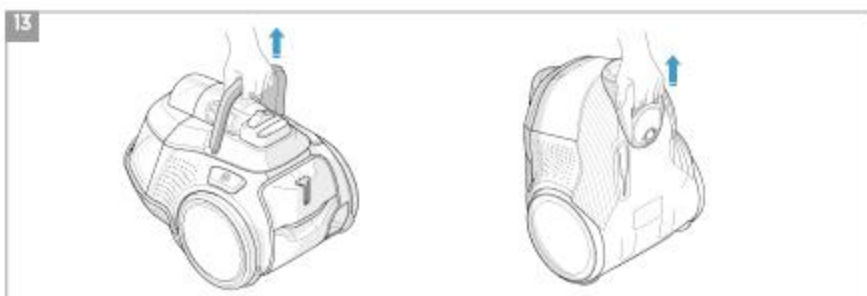

4 먼지통 비우기

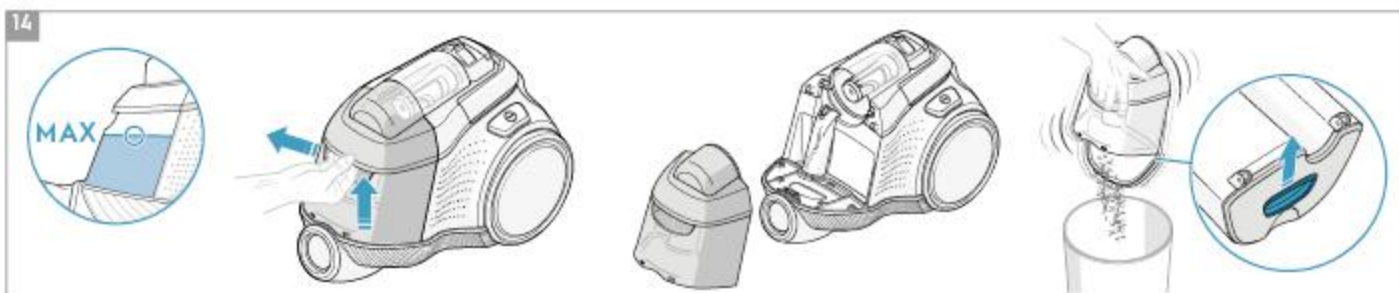

5 필터 청소

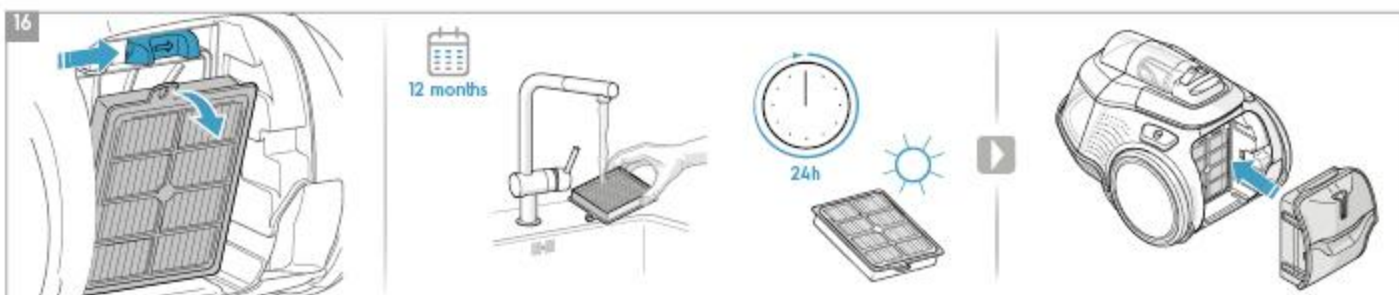
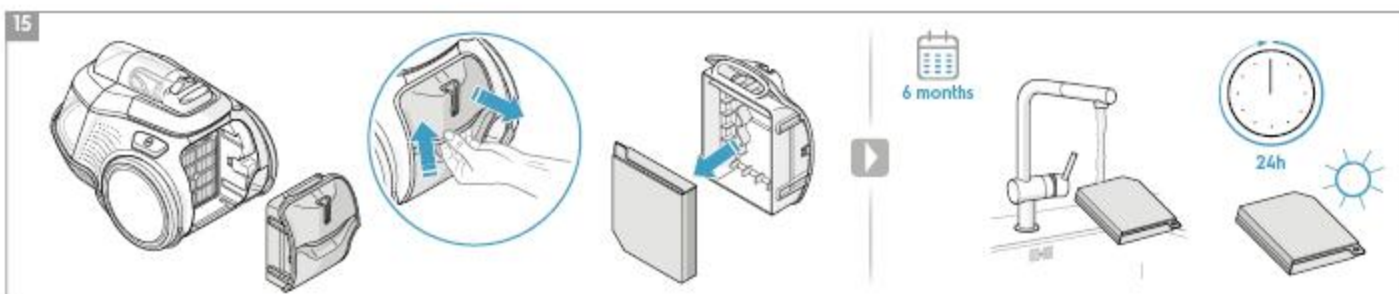

5 필터 청소

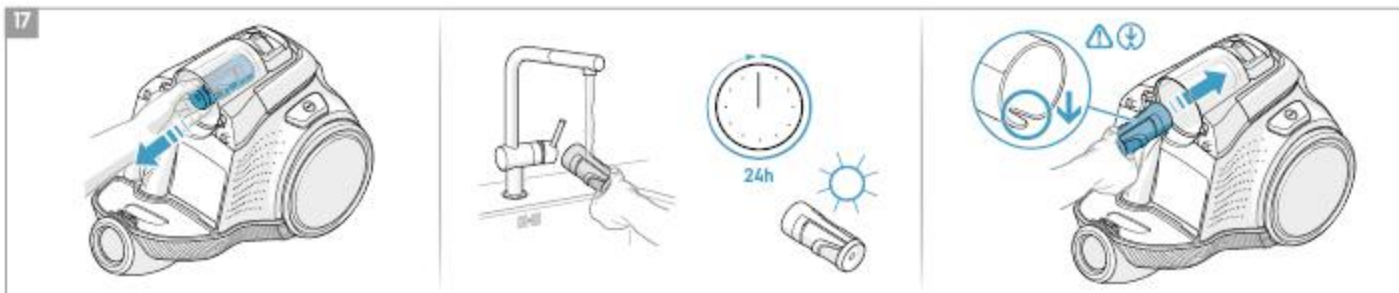

6 유지보수

* 특정 모델만 해당



7 시스템 검사

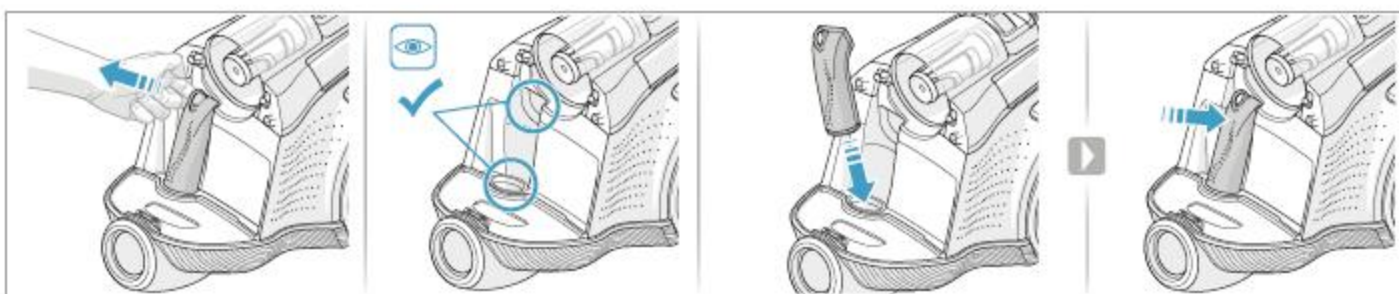
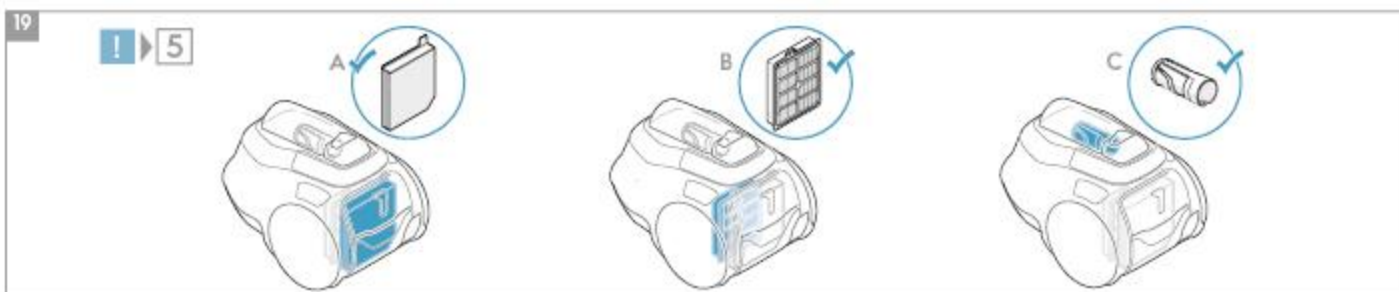

안전 예방책

만 8세 이상의 어린이나, 신체적, 감각적, 또는 정신적 능력이 저하되거나 경험과 지식이 부족한 사람이 이 제품을 사용하고자 하는 경우, 안전한 사용 방법에 대한 감독 또는 주의를 받고 관련 위험 요소에 대해 이해하는 경우 사용이 가능합니다.

어린이가 제품을 가지고 장난하지 않도록 세심한 주의를 기울여야 합니다.

어린이는 성인의 감독 없이 제품을 청소하거나 유지보수해서는 안 됩니다.

경고: 터보 노즐*에는 부품이 끼일 수 있는 회전 브러시가 포함되어 있습니다. 주의를 기울여 사용하고자 하는 표면에만 사용해 주십시오. 끼인 부품을 제거하거나 브러시를 청소하기 전에 진공청소기를 꺼주십시오.

제품을 폐기하기 전에 핸들* 노즐의 LED라이트를 제어하는 배터리를 제거해 주십시오**.

***특정 모델만 해당**

****배터리 제거 방법에 대한 정보는 섹션 6 및 7에 나와 있습니다.**

제품을 청소하거나 유지보수하기 전에 또는 배터리를 제거할 때는 항상 전원 소켓에서 플러그를 분리하십시오. 배터리는 안전하게 폐기해야 합니다.

코드가 손상된 경우, 위험을 방지하기 위해 공식 Electrolux 서비스 센터에서만 교체해야 합니다.

Pure C9은 국내 환경에서 일반 실내 진공 청소용으로만 사용해야 합니다. 진공청소기는 반드시 건조한 장소에 보관하십시오.

모든 서비스 또는 수리는 공식 Electrolux 서비스 센터에서만 수행해야 합니다.

질식 사고 위험을 방지하려면 비닐봉지 등 포장재는 어린이의 손이 닿지 않는 곳에 두어야 합니다.

진공청소기를 절대 사용해서는 안 되는 경우:

젖은 곳.

인화성 가스 등이 가까이에 있는 곳.

제품에 눈에 보이는 손상의 징후가 있을 때.

날카로운 물체 또는 액체 위에서.

바닥 노즐에 눈에 보이는 손상의 징후가 있을 때.

뜨겁거나 차가운 재, 불이 붙은 담배꽂초 등에서.

석고, 콘크리트, 밀가루와 같은 미세 먼지가 있는 환경에서

진공청소기를 직사광선 아래에 두지 마십시오.

진공청소기를 강한 열이나 빙점 온도에 노출하지 마십시오.

필터가 없는 상태로 진공청소기를 절대 사용하지 마십시오.

청소기 스위치가 켜져 있고 브러쉬 롤이 돌고 있을 때는 브러쉬 롤을 만지려고 시도하지 마십시오.

휠이 막혀 있을 때.

필터가 손상되었거나 부러진 경우 진공청소기를 사용하지 마십시오.

전원 코드 예방책

플러그와 코드를 정기적으로 점검하십시오. 플러그 또는 코드가 손상된 경우 진공청소기를 절대 사용하지 마십시오.

진공청소기의 코드 손상은 보증 적용 대상에서 제외됩니다.

코드로 진공청소기를 절대로 당기거나 들어 올리지 마십시오.

위와 같은 상황에서 진공청소기를 사용하면 사람에게 심각한 부상이나 제품에 심각한 손상을 입힐 수 있습니다. 그렇게 발생한 부상이나 손상은 보증 혜택을 받을 수 없으며 Electrolux에서 서비스를 제공하지 않습니다.

서비스 및 보증

모든 서비스 또는 수리는 공식 Electrolux 서비스 센터에서만 수행해야 합니다.

진공청소기의 코드 손상은 보증 적용 대상에서 제외됩니다. 액체 진공 흡입, 제품을 액체에 담그거나 손상된 호스 및 노즐과 함께 제품을 사용함으로써 인해 발생한 모터 손상은 보증 적용 대상에서 제외됩니다.

폐기



제품에 표시된 이 기호는 본 제품에 일반 가정용 쓰레기와 함께 처리해서는 안 되는 배터리가 포함되어 있음을 나타냅니다.



제품 또는 포장재에 표시된 이 기호는 제품을 가정용 쓰레기로 처리할 수 없다는 표시입니다.

제품을 재활용하려면, 배터리와 전기 부품을 안전하고 전문적인 방식으로 제거하여 재활용할 수 있는 공식 수거 지점 또는 Electrolux 서비스 센터로 가져 가십시오. 전자 제품 및 재활용 가능한 배터리의 분리 수거는 국가의 규정을 따르십시오.

이로써, Electrolux Home Care and SDA는 무선 설비 유형 FOR1, FOR2 및 FOR3이 있는 진공청소기가 Directive 2014/53/EU를 준수하고 있음을 선언합니다.

Electrolux Pure C9 진공청소기를 선택해 주셔서 감사합니다. 최상의 결과를 얻으려면 항상 정품 액세서리와 부품을 사용하십시오. 본 제품은 환경을 염두에 두고 설계되었습니다. 모든 플라스틱 부품은 재활용할 수 있도록 표시되어 있습니다.

시작하기 전에

- 본 설명서를 주의 깊게 읽으십시오.
- 설명되어 있는 모든 부품이 포함되어 있는지 확인하십시오.
- 안전 예방책에 특히 주의하십시오!

PURE C9 진공청소기에 대한 설명

- | | |
|------------------------|----------------------------------|
| A. 디스플레이 | 노즐 액세서리 |
| A1 회전식 노브 제어* | |
| A2 원격 제어* | |
| B. 배기 필터 덮개 | K. AeroPro 3in1 노즐 |
| C. 미세 먼지 필터 | T. 모터 구동 노즐* |
| D. 헤파필터 | U. FlowMotion 노즐* |
| E. 보관 슬롯 | V. FlowMotion LED 노즐 (청면 조명 있음)* |
| F. 전원 코드 | W. AeroPro Turbo 노즐* |
| G. 이동용 손잡이 | X. AeroPro Mini Turbo 노즐* |
| H. 사이클론칸 및 노즈콘 필터 | Y. ParkettoPro 노즐* |
| I. 공기 통로 | Z. AeroPro FlexProPlus 노즐* |
| J. 먼지통 | AA. AeroPro Long 틸트 노즐* |
| L. AeroPro 호스 | AB. BedPro 노즐* |
| M. AeroPro 핸들 | |
| M1 AeroPro Classic 핸들* | |
| M2 AeroPro Ergo 핸들* | * 선택한 모델만 해당 |
| M3 AeroPro 리모컨 조절 핸들* | |
| N. AeroPro 길이 조절 튜브 | |
| O. 보관 슬롯 | |

그림 페이지2-6

진공청소기 사용 방법

- 1 진공청소기를 사용하기 전에 모든 필터가 제대로 장착되어 있는지 확인하십시오.
- 2 호스를 청소기에 끼웁니다(분리하려면 잠금 버튼을 누르고 잡아 당깁니다). 잠금 버튼에서 딸락하는 소리가 날 때까지 호스를 호스 핸들에 끼웁니다(분리하려면, 잠금 버튼을 누르고 잡아 당깁니다).
- 3 길이 조절 튜브를 노즐에 장착합니다. 길이 조절 튜브를 호스 핸들에 장착합니다(분리하려면 잠금 버튼을 누르고 잡아 당깁니다).
- 4 한 손으로 잠금 버튼을 잡고 다른 손으로는 핸들을 잡아 당겨서 길이 조절 튜브를 조정합니다.

3IN1 액세서리 도구

- 5 쉽게 집금할 수 있도록 핸들 아래에 있는 클립 고정식 홀더와 3in1 노즐을 고정시킬 수 있습니다. 도구에는 3가지 기능이 있는데, 다음 페이지의 그림을 참조하십시오.

배터리 교환*

- 6 청면 조명이 있는 노즐*: 처음 사용하기 전에 보호 필름(배터리 상단에 있음)을 제거하십시오. 청면 조명이 빠르게 깜박이기 시작할 때 배터리를 교환하십시오. AA 배터리 2개를 사용하십시오.
 - 7 원격 제어 기능이 있는 핸들*: 조명 표시등이 적색으로 바뀌거나 버튼을 눌러도 반응하지 않을 경우 배터리를 교환하십시오. 리튬 CR1632의 배터리 종류만 사용하십시오.
- 주의: 폐기하기 전에 제품에서 배터리를 제거하십시오. 배터리 및 전자 제품의 수거는 해당 국가의 규정을 따르십시오.

진공청소기를 시작/중지하고 출입력을 조정합니다.

- 8 전원 코드를 당겨 꺼내어 플러그를 전원 소켓에 꽂습니다. ON/OFF 버튼을 눌러서 청소기를 켜거나/ 끕니다. 원격 제어 기능이 있는 모델은 핸들에 있는 ON/OFF 버튼으로 작동할 수도 있습니다.*
- 9 청소 후에 REWIND (되감기) 버튼을 눌러서 케이블을 되감습니다.
- 10 출입력 조정(수동 제어 모델): 청소기의 회전식 노브를 켜거나 핸들의 공기 밸브를 사용하십시오.*
출입력 조정(원격 제어 모델): 핸들 위에 있는 +/- 버튼을 누릅니다. 디스플레이의 MIN/MAX 및 기호 표시기가 파워 레벨을 표시합니다.*

범용 노즐로 진공 청소(V*, W*)

- 11 페달로 노즐 설정을 변경합니다. 아이콘은 권장하는 바닥 종류(단단한 바닥 또는 카펫)를 보여 줍니다. FlowMotion LED 노즐* 노즐을 앞쪽으로 이동합니다. 몇 초 후에 청면 조명이 자동으로 켜집니다. 노즐을 사용하지 않으면 몇 초 후에 조명이 자동으로 꺼집니다.

보관 위치, 진공청소기 이동

- 12 진공청소기로 청소하는 동안 일시 정지할 때는 진공청소기 뒤편에 있는 보관 슬롯(1)을 사용하십시오. 진공청소기를 운반해서 보관하려면 진공청소기 아래에 있는 보관 슬롯(2)을 사용하십시오.
- 13 진공청소기에는 두 개의 운반 핸들이 있습니다.

먼지통 비우기

- 14 먼지통의 먼지가 "최대 - MAX" 표시까지 차면 먼지통을 비우셔야 합니다. 탈착 버튼을 누르고 먼지통을 당겨 분리합니다. 먼지통 하단의 잠금 해제 버튼을 누르고 휴지통을 향해 두껍을 엽니다. 먼지통을 비운 후 역순으로 다시 장착합니다.

필터 교체

- 15 필터 버튼을 당겨서 필터 뚜껑을 엽니다. 6개월 사용했거나 먼지가 보일 경우 미세 먼지 필터를 청소하십시오. 프레임의 탭을 당겨서 미세 먼지 필터를 제거합니다. 흐르는 물 아래에서 필터를 씻어 냅니다. 주의: 세제를 사용하지 마십시오. 필터를 다시 끼우기 전에 필터를 완전히 건조시키십시오(실온에서 최소 24시간!).
- 16 헤파 필터를 고정하고 있는 잠금 장치를 오른쪽 방향으로 밀어서 잠금을 해제하고 헤파 필터를 분리합니다. 12개월 사용 후 세척을 권장합니다. Electrolux에서 권장하는 정품 s-필터만 사용하십시오(소모품 및 액세서리 참조). 미지근한 수돗물로 내부(더러운 쪽)을 씻어 냅니다. 필터 프레임에 두드러져 물을 제거합니다. 위 과정을 네 번 반복합니다.

주의: 세제를 사용하지 마십시오. 필터 표면을 만지지 마십시오. 필터를 다시 끼우기 전에 필터를 완전히 건조시키십시오(실온에서 최소 24시간)! 세척 가능한 필터는 일년에 한 번 또는 매우 더럽거나 손상되었을 때 교환하십시오. 필터를 교체한후, 제자리에 장착하고 딸락 소리가 나게 덮개를 닫습니다.









- 17 노즈콘 필터 청소: 노즈콘 필터는 사이클론칸 안쪽에 있습니다. 먼지가 들어간 경우 노즈콘 필터를 청소합니다. 노즈콘 필터를 당겨서 분리합니다. 손으로 먼지를 제거합니다. 심하게 때가 묻은 경우 흐르는 물로 청소하십시오. 역순으로 다시 장착합니다. 주의: 세제를 사용하지 마십시오. 필터를 다시 끼우기 전에 필터를 완전히 건조시키십시오(실온에서 최소 24시간!).

범용 노즐(V*, W**) 및 터보 노즐(X*) 청소

- 18 튜브에서 범용 노즐을 분리합니다. 호스 핸들로 청소하십시오. 튜브에서 터보 노즐을 분리하고 가위로 잘라진 잉킨 이물들을 제거합니다. 호스 핸들을 사용해서 노즐을 청소합니다.*

Pure C9으로 최상의 청소를 경험해 보세요!

Electrolux는 사전 통지 없이 제품, 정보 및 사양을 변경할 수 있는 권리를 보유합니다.

| 노즐/액세서리 | 다음에 사용: | 노즐/액세서리 | 다음에 사용: |
|---|--|--|---|
| T. 모터 구동 노즐*  | 카펫 노즐: - 모터 구동 노즐을 사용하면 가장 강력한 먼지 흡입력을 경험할 수 있으며 카펫 위에서 진동하는 회전식 브러쉬 롤러를 통해 카펫을 보다 깨끗이 청소할 수 있습니다. - 브러쉬 롤러가 켜진 상태에서 모터 구동 노즐을 그대로 두지 마십시오. | U.FlowMotion 노즐* V. FlowMotion LED 노즐*  | 범용 노즐: - 카펫 및 마루바닥 등 모든 종류의 바닥에서 먼지를 강력하게 제거합니다. - 듀얼 모드의 노즐로 바닥 타입에 따라 설정을 변경할 수 있습니다. 권장하는 바닥 종류가 노즐 위 아이콘으로 표시되어 있습니다. - 노즐의 정면 LED 라이트는 어두운 장소에서 (가구 아래 등) 먼지를 발견할 수 있도록 해 줍니다. <i>PureVision만 해당</i> |
| W. Turbo 노즐*  | 터보 노즐 (카펫용): - 브러쉬가 머리카락 및 섬유들을 강하게 흡입해 줍니다. - 브러쉬롤러는 청소기의 강한 공기흐름으로 인해 회전합니다. - 털이 긴 카펫, 방수 카펫이나 도어매트 등에는 적합하지 않습니다. 대신 범용 노즐을 사용합니다. | X. 미니 터보 노즐*  | 미니 터보 노즐: - 머리카락, 섬유들을 강하게 흡입해 줍니다. - 직물, 유아용 카시트, 매트리스 등에 사용 - 브러쉬롤러는 청소기의 강한 공기흐름으로 인해 회전합니다. - 브러쉬 롤에 이물질이 걸릴 수 있으므로 털이 긴 카펫의 경우 적합하지 않습니다. |
| Y. ParkettoPro 노즐*  | 파케토 프로 노즐: - 단단한 바닥(쪽모이 세공 바닥, 마루, 타일 등)을 부드럽게 청소하는 경우. - 틈이 있는 단단한 바닥에서 최상의 먼지 청소. | Z. 플렉스 프로 플러스 노즐*  | 플렉스 프로 플러스 노즐: - 가구, 모서리 및 기타 장애물들 사이에 적합 - 좁은 틈새도 쉽게 들어갈 수 있도록 180도 회전이 가능합니다. |
| AA. 긴 틈새 노즐*  | 긴 틈새 노즐: - 접근하기 힘든 영역의 경우(선반 위 등) - 손이 닿지 않는 좁은 틈새의 경우 | AB. BedPro 노즐*  | 베드프로(침구) 노즐: - 침구 및 매트리스에서 먼지와 집먼지 진드기를 제거합니다. |
| K. 3in1 액세서리 노즐*  | | | 3가지 기능이 가능한 노즐: 1. 단단한 표면용 (책장, 가구 등) 2. 페브릭용 (커튼, 덮개 등) 3. 좁은 틈새용 |

수동 출력 제어 기능이 있는 모델
 - 최적의 성능을 위해 청소기에 있는 그림을 참조합니다.

문제해결

| 문제 | 해결책 |
|--|---|
| 진공청소기가 작동하지 않습니다. | <ul style="list-style-type: none"> 케이블이 전원 소켓에 연결되어 있는지 확인하십시오. 플러그와 케이블이 손상되지 않았는지 점검하십시오. 퓨즈가 끊어졌는지 점검하십시오. 원격 제어 핸들의 배터리 표시기 램프가 반응하는지 점검하십시오(특정 모델만 해당). |
| 청소기가 멈춥니다 | 청소기가 과열되었을 수 있습니다. 전원 소켓에서 연결을 차단하고, 노즐, 튜브, 호스 또는 필터가 막혔는지 점검하십시오. 플러그를 다시 꽂기 전에 120분간 청소기를 식히십시오. 계속해서 청소기가 작동하지 않을 경우, 공인 Electrolux 서비스 센터에 문의하십시오. |
| 정상 출력 대비 갑작스러운 흡입 능력 감소 | <ul style="list-style-type: none"> 먼지통이 꽉 찼거나 막혔는지 점검하십시오. 공기 통로 및 배기구가 막혀서 청소를 해야 하는지 점검하십시오. 헤파 필터가 막혀서 교환이 필요한지 점검하십시오. 노즐이 막혀서 청소해야 하는지 점검하십시오. 호스를 살짝 쥐어서 막혔는지 확인하십시오. 단, 호스 안쪽에 들어간 유리 또는 바늘로 인해 막힘이 발생한 경우 조심하십시오. 참고: 청소하는 과정에서 손상된 호스의 경우에는, 보증 수리를 받으실 수 없습니다. |
| 진공청소기에 물이 빨려 들어갔습니다 | 공인 Electrolux 서비스 센터에서 모터를 교체해야 합니다. 물의 유입으로 인해 손상된 모터에 대해서는 보증 수리가 적용되지 않습니다. |
| 이외의 문제가 발생하는 경우, 공식 Electrolux 서비스 센터에 문의하십시오. | |

소모품 및 액세서리



해당 제품의 소모품 및 액세서리 구입처:

www.electroluxshop.co.kr
<https://shop.electrolux.com.au/>

소모품 및 액세서리 가용 여부는 지역 및 국가에 따라 다릅니다.
 자세한 내용은 현지 Electrolux 웹사이트를 참조하거나 현지 고객 서비스 상담센터에 문의하여 지원을 받으십시오.

S-필터



PureAdvantage D11 세척 가능
 (호주, 뉴질랜드)

HEPA 13 세척 가능

S-프레시



크리스프 밤부
 트로피칼 브리즈
 브라운슈가&무화과
 이브닝 로즈
 시트러스 버스트

노즐*



사일런트 파케토



더스트마그넷 사일런트

키트



델리키트 케어 키트



클린 앤 타이디 키트

* 액세서리 가용 여부는 튜브 치수에 따라 다릅니다

고객 관리 및 서비스

서비스에 문의할 때는 다음과 같은 데이터를 확인할 수 있는지 확인하십시오.

- 모델 번호
- PNC 번호
- 일련번호

위의 정보는 명판에서 확인할 수 있습니다.

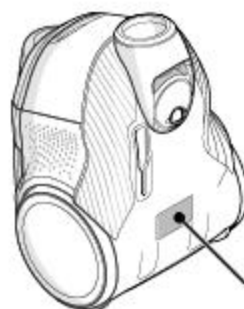

| 모델 번호 | PNC 번호 | 일련번호 |
|---|------------------|--------------------------|
| | | |
| Model Code TBD | PNC 910287894 | Serial No. 12345678 |
| | | Type FNA 550 W NCM |
| 230V ~ 50 Hz | | Model ID |
| Electrolux Appliances AB S-1 Genarogatan 10 SE-100 40 Stockholm, Sweden | | |

다음 웹사이트 방문:



다음에서 사용법 조언, 책자,
 문제 해결사, 서비스 정보 받기
www.electrolux.com

1. GAMBARAN UMUM PRODUK

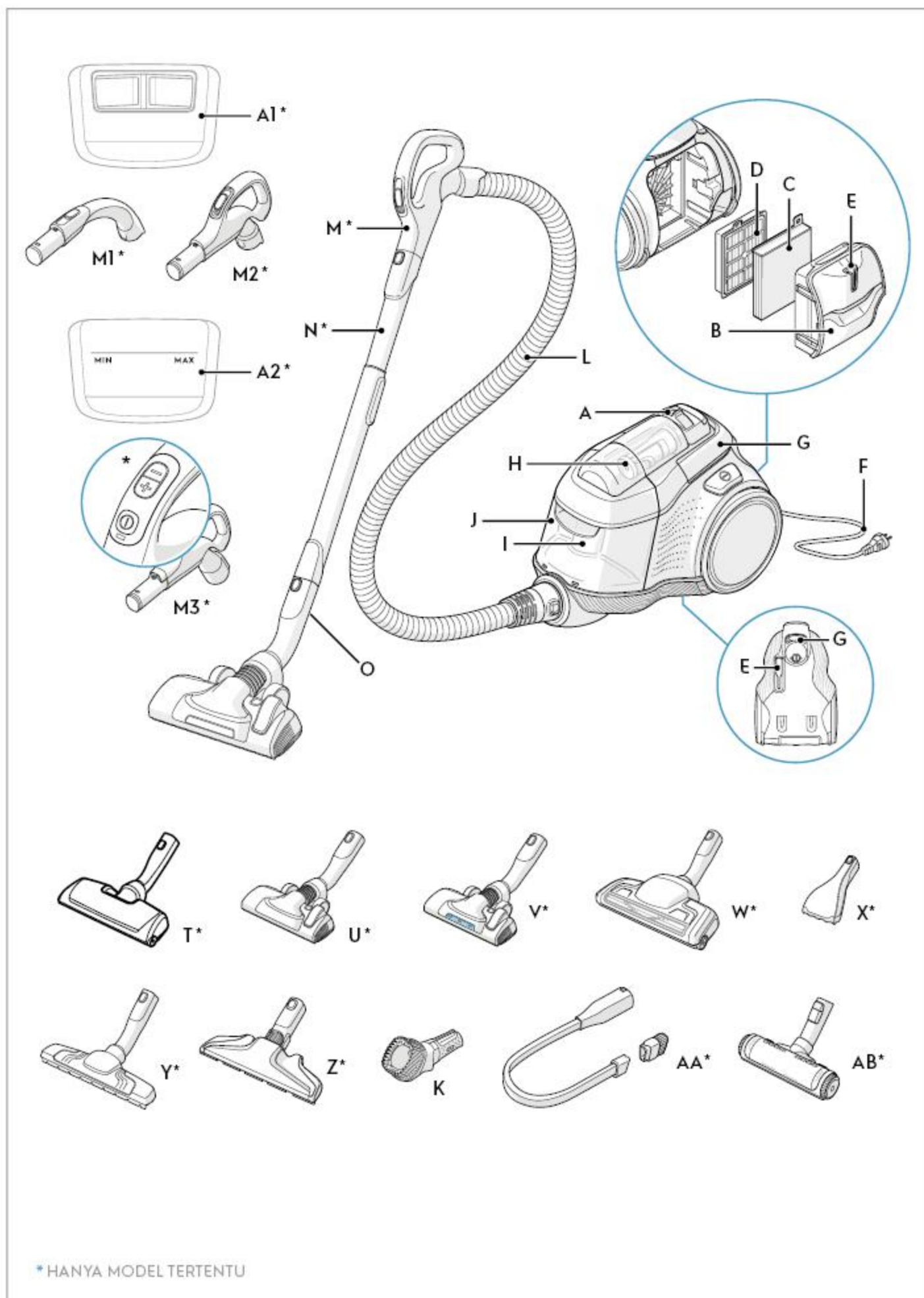

2. PEMASANGAN

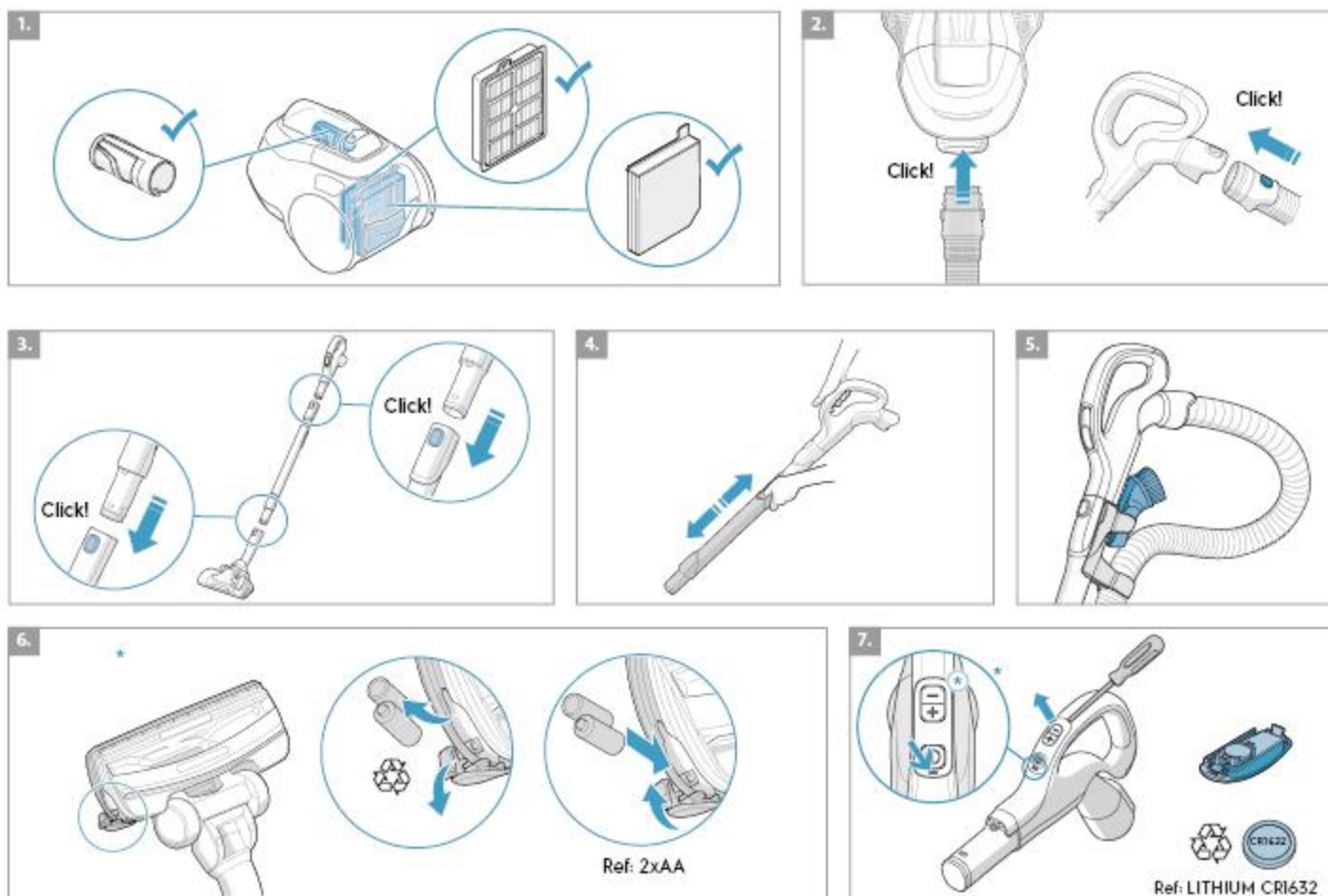

3. MEMAKAI PRODUK

* HANYA MODEL TERTENTU

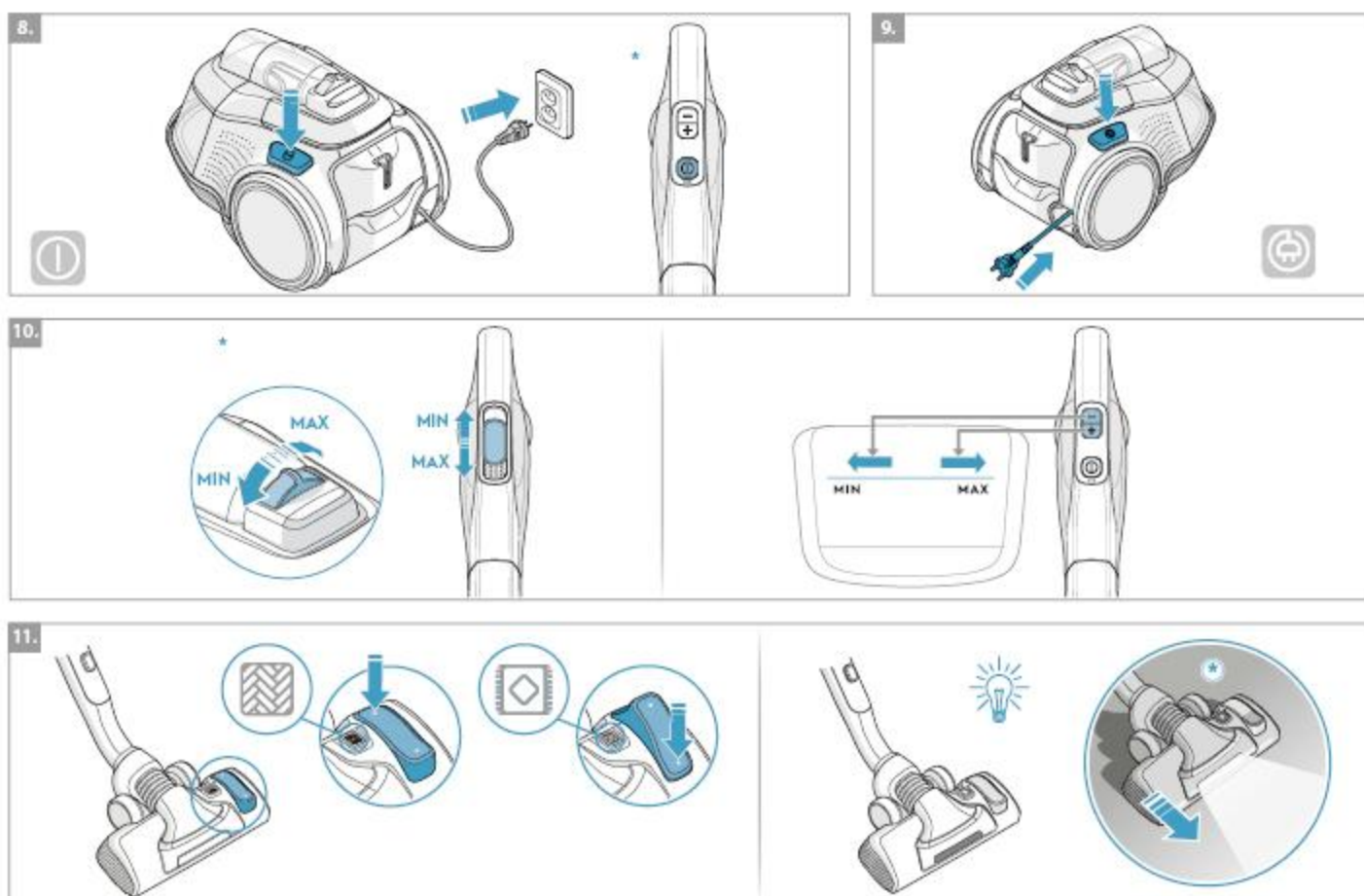

3. MEMAKAI PRODUK

*HANYA MODEL TERTENTU

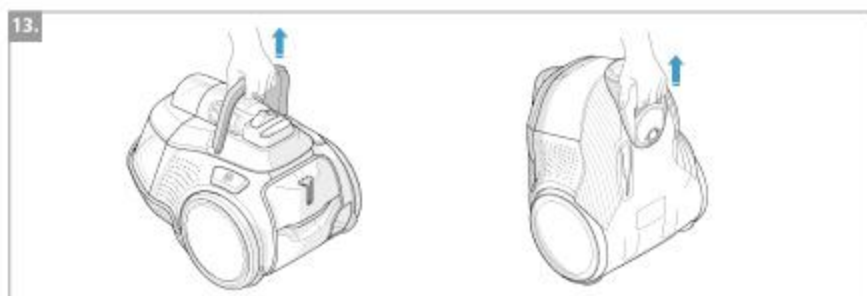

4. MEMBUANG DEBU

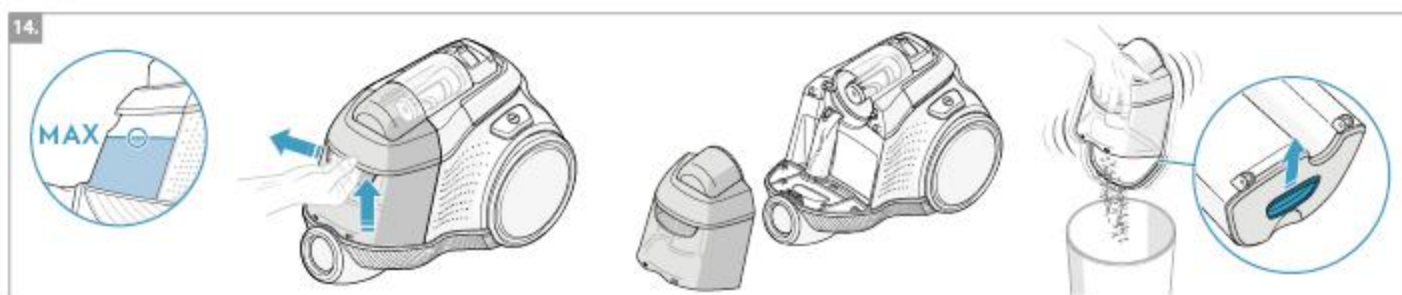

5. MEMBERSIHKAN FILTER

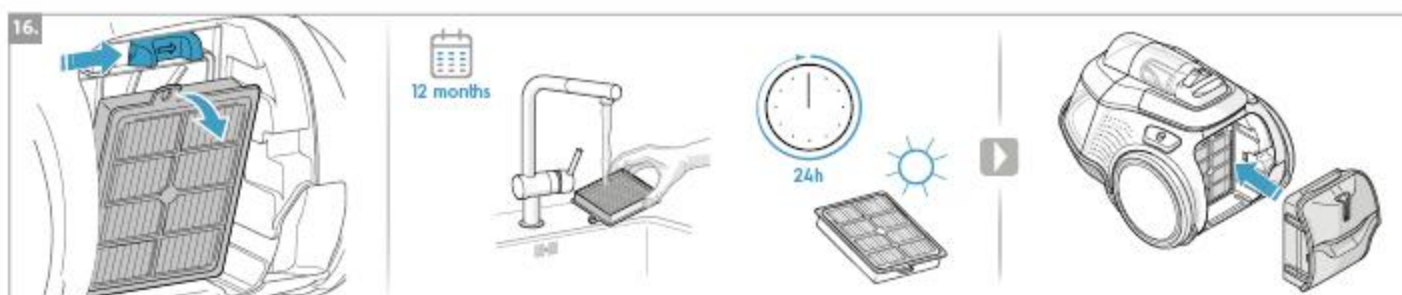
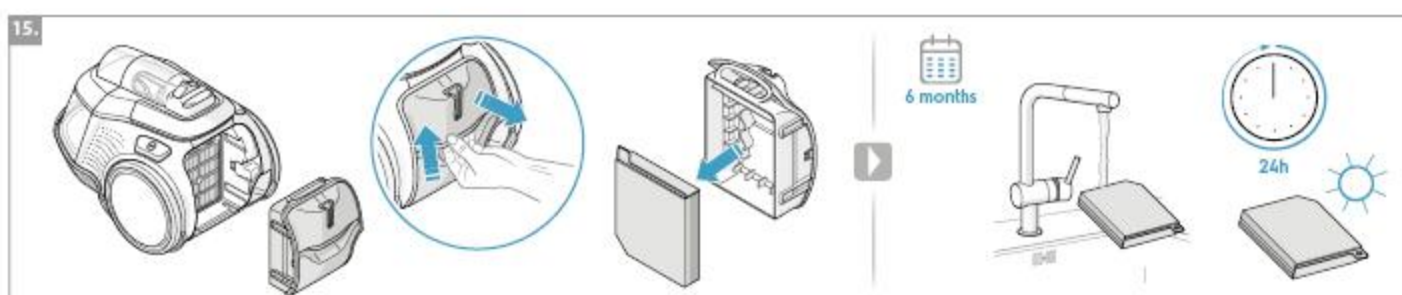

5 MEMBERSIHKAN FILTER

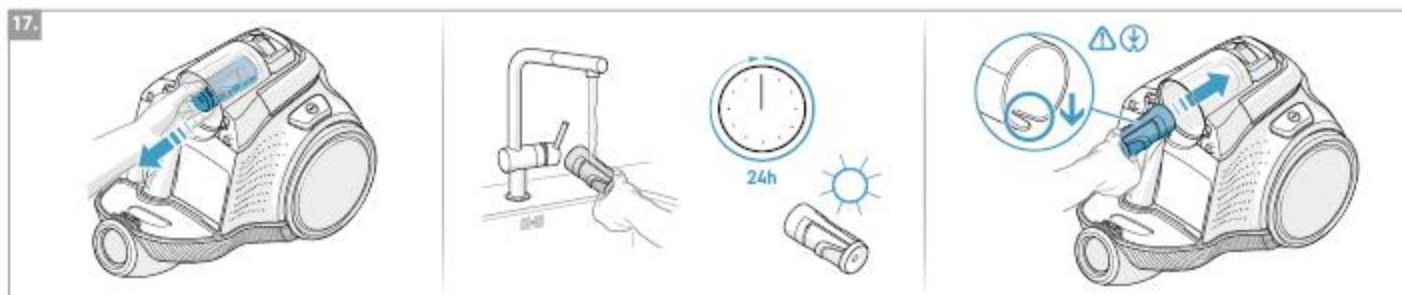

6. PEMELIHARAAN

* HANYA MODEL TERTENTU

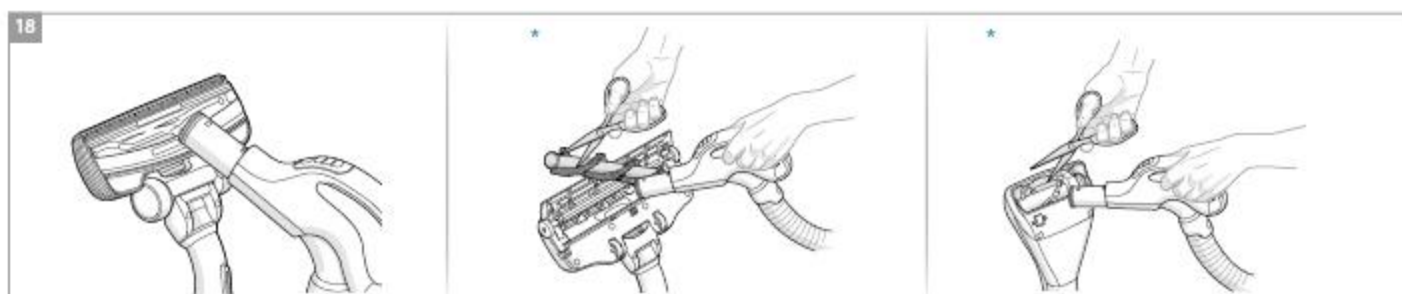

7. PEMERIKSAAN SISTEM

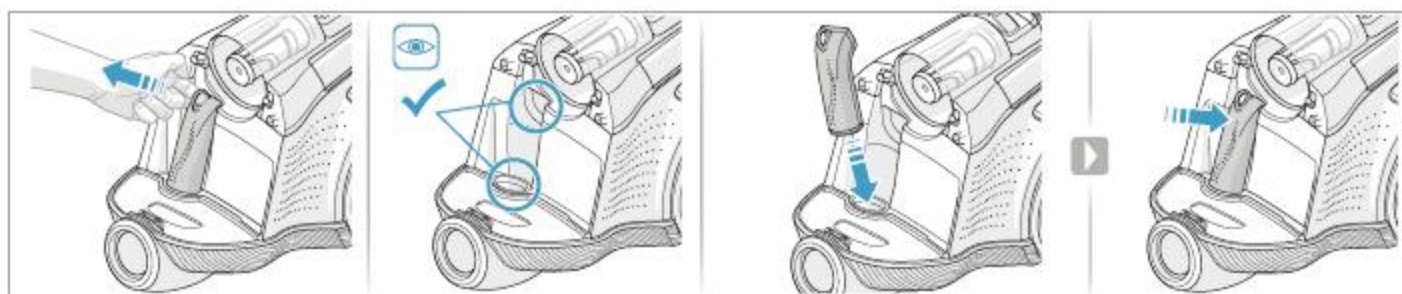
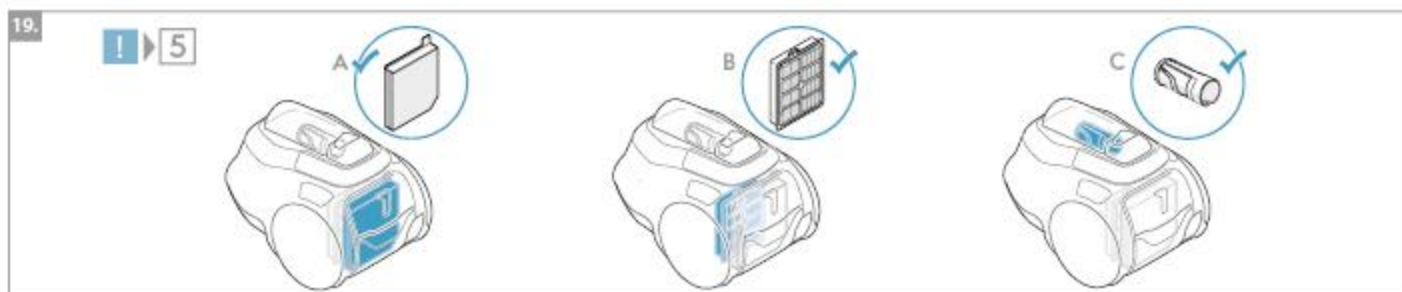

PETUNJUK KESELAMATAN

Perangkat ini dapat digunakan oleh anak-anak berusia 8 tahun ke atas dan orang dengan kemampuan fisik, sensor, atau jiwa yang tidak sempurna atau tidak berpengalaman dan berpengetahuan minim jika mereka telah diberikan pengawasan atau petunjuk mengenai penggunaan perangkat dengan cara yang aman dan memahami risiko bahaya yang terkait. Anak-anak harus selalu diawasi agar mereka tidak memainkan perangkat ini.

Dilarang membersihkan dan merawat perangkat oleh anak-anak tanpa pengawasan.

PERINGATAN: Nosel turbo* memiliki sikat berputar yang dapat membuat benda-benda terperangkap di dalamnya. Mohon gunakan dengan hati-hati dan hanya pada permukaan yang sesuai. Mohon matikan penyedot debu. sebelum melepas benda-benda yang terperangkap atau ketika membersihkan sikat.

Baterai harus dilepas dari remote control pada handel*/lampu LED yang menyala* sebelum membuang produk**.

* Hanya model tertentu.

** Informasi tentang cara melepas baterai ada pada bagian 6 dan 7.

Lepaskan selalu colokan dari sumber listrik sebelum alat dibersihkan atau dirawat atau ketika melepas baterai. Baterai harus dibuang dengan aman.

Apabila kabel rusak, kabel harus diganti oleh pusat servis resmi Electrolux saja untuk menghindari bahaya.

Pure C9 hanya boleh dipakai untuk penyedotan debu dalam jumlah normal di dalam ruangan dan di lingkungan rumah tangga. Pastikan penyedot debu disimpan di tempat yang kering. Semua servis atau perbaikan harus dilakukan oleh pusat layanan resmi Electrolux. Materi kemasan, misalnya kantong plastik tidak boleh diberikan kepada anak-anak agar tidak tercekik.

Jangan pernah sekali-kali memakai penyedot debu:

Di tempat basah.

Dekat gas yang mudah terbakar, dll.

Jika produk tampak menunjukkan gejala-gejala kerusakan.

Pada benda tajam atau cairan.

Jika nosel lantai menunjukkan tanda-tanda kerusakan.

Pada abu yang panas atau dingin, puntung rokok yang menyala, dll.

Pada debu halus, misalnya dari aci tembok, beton, tepung, abu panas atau dingin.

Jangan biarkan penyedot debu berada di bawah sinar matahari langsung.

Jangan mendekatkan penyedot debu pada sumber panas yang kuat atau suhu beku.

Jangan pernah menggunakan penyedot debu tanpa filter.

Jangan mencoba menyentuh rol sikat saat penyedot debu dihidupkan dan rol sikat berputar.

Ketika roda terhalang.

Jangan gunakan penyedot debu Anda jika filter rusak atau tidak berfungsi.

Peringatan tentang kabel listrik

Periksa colokan dan kabel secara berkala. Jangan pernah memakai penyedot debu jika colokan atau kabel rusak.

Kerusakan pada kabel penyedot debu tidak tercakup dalam garansi.

Jangan menarik atau mengangkat penyedot debu pada kabelnya.

Menggunakan penyedot debu dalam kondisi di atas bisa mengakibatkan cedera atau kerusakan serius pada produk. Cedera atau kerusakan seperti itu tidak dilindungi di dalam garansi atau oleh Electrolux.

SERVIS DAN GARANSI

Semua servis atau perbaikan harus dilakukan oleh pusat layanan resmi Electrolux.

Kerusakan pada kabel penyedot debu tidak tercakup dalam garansi.

Kerusakan pada motor karena: menyedot cairan, merendam alat dalam cairan atau memakai alat dengan selang dan nosel dalam keadaan rusak tidak dicakup dalam garansi.

PEMBUANGAN



Simbol pada produk ini menunjukkan bahwa produk mengandung baterai yang tidak boleh dibuang bersama limbah rumah tangga biasa.



Simbol ini pada produk atau pada kemasannya menunjukkan bahwa produk tersebut mungkin tidak diperlakukan sebagai sampah rumah tangga.

Untuk mendaur ulang produk Anda, bawalah ke tempat pengumpulan resmi atau ke pusat servis Electrolux yang bisa melepas dan mendaur ulang baterai serta listrik dengan aman dan profesional. Ikuti peraturan yang berlaku di negara Anda mengenai pemisahan pengumpulan produk elektronik dan baterai yang dapat diisi ulang.

Dengan ini, Electrolux Home Care dan SDA, menyatakan bahwa Penyedot Debu dengan tipe peralatan radio FOR1, FOR2, dan FOR3 telah sesuai dengan Arahannya 2014/53/EU.

BAHASA INDONESIA

Terima kasih telah memilih Electrolux Pure C9 penyedot debu. Selalu pakai aksesoris dan suku cadang asli untuk memperoleh hasil terbaik. Produk ini dirancang dengan mempertimbangkan lingkungan. Semua komponen yang mengandung plastik diberi tanda agar dapat didaur ulang.

SEBELUM MEMULAI

- Bacalah petunjuk ini dengan cermat.
- Periksa apakah semua komponen yang dijelaskan sudah disertakan.
- Perhatikan secara khusus tindakan pencegahan keamanannya!

KETERANGAN PENYEDOT DEBU PURE C9

| A. Layar | Aksesoris Nosel |
|--|---|
| A1 kontrol tombol putar* | K. Alat AeroPro 3 in 1 |
| A2 remote control* | T. Nosel Bermotor* |
| B. Tutup filter | U. Nosel FlowMotion* |
| C. Filter debu halus | V. Nosel LED FlowMotion (dengan lampu depan)* |
| D. Filter pra-motor | W. Nosel Turbo AeroPro* |
| E. Selot parkir | X. Nosel Mini Turbo* |
| F. Kabel daya | Y. Nosel ParkettoPro* |
| G. Pegangan jinjing | Z. Nosel AeroPro FlexProPlus* |
| H. Kompartemen siklon dan filter ujung kerucut | AA. Nosel celah Panjang AeroPro* |
| I. Saluran udara | AB. Nosel BedPro* |
| J. Kompartemen debu | |
| L. Selang AeroPro | |
| M. Handel AeroPro | |
| M1 handel AeroPro Classic* | * Hanya model tertentu |
| M2 Handel AeroPro Ergo* | |
| M3 Handel Remote Control AeroPro* | |
| N. Tabung teleskopik AeroPro | |
| O. Klip parkir | |

Halaman gambar 2-6

CARA MEMAKAI PENYEDOT DEBU.

- 1 Periksa apakah semua filter telah terpasang dengan benar sebelum menggunakan penyedot debu.
- 2 Masukkan selang ke dalam pembersih (untuk melepaskannya, tekan tombol kunci lalu tarik). Masukkan selang ke handel selang sampai tombol mengeluarkan suara klik tanda terkunci (untuk melepaskannya, tekan tombol kunci lalu tarik).
- 3 Pasang tabung teleskopik ke nosel. Pasang tabung teleskopik ke handel selang (untuk melepaskannya, tekan tombol kunci lalu tarik).
- 4 Sesuaikan tabung teleskopik dengan memegang kunci dengan satu tangan lalu tarik pegangan dengan tangan yang lain.

ALAT AKSESORI 3 IN 1

- 5 Anda dapat mengencangkanudukan klip dan alat 3 in 1 di bawah handel agar mudah diakses. Alat ini memiliki 3 fungsi, lihat gambar di halaman berikut.

MENGISI DAYA BATERAI*

- 6 Nosel dengan lampu depan *: Sebelum pertama kali digunakan, lepaskan lapisan film pelindung (di atas baterai). Ganti baterai jika lampu depan mulai berkedip cepat. Pakai baterai 2 AA.
- 7 Tangani dengan remote control *: Ganti baterai jika lampu indikator berubah menjadi merah atau tidak merespons jika sembarang tombol ditekan. Gunakan hanya baterai jenis LITHIUM CR1632.
N.B.: Keluarkan baterai dari produk sebelum dibuang. Patuhi aturan di negara Anda mengenai pengumpulan baterai dan produk elektronik.

NYALAKAN/MATIKAN PENYEDOT DEBU DAN SESUAIKAN KEKUATAN SEDOTNYA.

- 8 Tarik kabel listrik dan sambungkan ke colokan listrik. Tekan tombol ON/OFF untuk menghidupkan/mematikan penyedot debu. Model dengan remote control juga bisa dioperasikan dengan tombol ON/OFF pada handel.*
- 9 Setelah dibersihkan, tekan tombol REWIND untuk menggulung kabel.
- 10 Sesuaikan kekuatan sedot (model kontrol manual): Putar tombol berputar pada penyedot debu atau gunakan katup udara pada handel.* Sesuaikan kekuatan sedot (model remote control): Tekan tombol +/- pada handel. Indikator MIN/MAX dan simbol yang ditampilkan pada layar akan menunjukkan besaran kekuatan sedot*

MENYEDOT DEBU DENGAN NOSEL UNIVERSAL (V*, W*)

- 11 Ganti pengaturan nosel dengan pedal. Ikon akan menunjukkan jenis lantai yang disarankan. (lantai keras atau karpet).
NoseL LED FlowMotion*: Pindahkan nosel ke depan. Lampu depan menyala otomatis setelah beberapa detik. Ketika nosel tidak dipakai, lampu akan otomatis mati setelah beberapa detik.

POSISI PARKIR, MEMINDAHKAN PENYEDOT DEBU

- 12 Gunakan posisi parkir (1), di bagian belakang penyedot debu, saat Anda berhenti sebentar saat menyedot debu.
Gunakan posisi parkir (2), di bawah penyedot debu, untuk membawa dan menyimpan penyedot debu.
- 13 Penyedot debu memiliki dua handel jinjing.

MENGOSONGKAN KOMPARTEMEN DEBU

- 14 Kosongkan kompartemen debu jika jumlah debu telah mencapai batas maksimum (tanda "MAX").
Tekan pelepas lalu tarik untuk melepas kompartemen debu.
Pegang kompartemen debu di atas tempat sampah. Tekan tombol buka kunci di bawah tutupnya, buka tutup dengan mengayunkannya ke arah luar. Kosongkan debu ke tempat sampah. Pasang kembali dalam urutan terbalik.

MENGGANTI FILTER

- 15 Tarik tombol FILTER untuk membuka tutup filter.
Bersihkan filter debu halus setelah pemakaian selama enam bulan, atau saat debu terlihat. Tarik sayap pada kerangka untuk melepas filter debu halus. Bersihkan filter di bawah air yang mengalir.
N.B. Jangan gunakan bahan pembersih. Biarkan saringan sepenuhnya kering (minimal 24 jam dalam suhu ruangan) sebelum digunakan kembali!

- 16 Tekan dan geser kunci mekanik ke kanan untuk melepas filter pra-motor. Lepas filter dengan menarik sayap kerangka filter.
Bersihkan filter pra-motor setelah penggunaan selama dua belas bulan. Gunakan s-filter asli yang Direkomendasikan oleh Electrolux (Lihat Barang Sekali Pakai dan Aksesoris). Bersihkan bagian dalam (sisi kotor) pada air keran hangat. Ketuk kerangka filter untuk membuang air. Ulangi proses hingga empat kali.

N.B.: Jangan gunakan bahan pembersih. Hindari menyentuh permukaan filter. Biarkan saringan sepenuhnya kering (minimal 24 jam dalam suhu ruangan) sebelum digunakan kembali! Ganti filter yang bisa dicuci sekurang-kurangnya setahun sekali atau jika terlihat sangat kotor atau rusak. Setelah mengganti filter, tutup penutup filter hingga terkunci kembali pada tempatnya.

- 17 **Membersihkan filter ujung kerucut:** filter ujung kerucut terletak di dalam kompartemen siklon. Bersihkan filter ujung kerucut jika debu sudah masuk. Tarik filter ujung kerucut untuk melepaskannya. Buang debu dengan tangan. Bersihkan di bawah air yang mengalir jika sangat kotor. Pasang kembali dalam urutan terbalik.
N.B. Jangan gunakan bahan pembersih. Biarkan saringan sepenuhnya kering (minimal 24 jam dalam suhu ruangan) sebelum digunakan kembali!









MEMBERSIHKAN NOSEL UNIVERSAL (V*, W**) DAN NOSEL TURBO (X*)

- 18 Lepaskan nosel universal dari tabung. Bersihkan dengan handel selang. Lepaskan nosel turbo dari tabung dan lepaskan benang yang terjat, dll. dengan memotongnya memakai gunting. Gunakan handel selang untuk membersihkan nosel.*

Nikmati pengalaman membersihkan terbaik dengan Pure C9!

Electrolux berhak mengganti produk, informasi, dan spesifikasi tanpa pemberitahuan sebelumnya.

TIPS MEMPEROLEH HASIL TERBAIK

| NOSEL/AKSESORI | PENGGUNAAN UNTUK: | NOSEL/AKSESORI | PENGGUNAAN UNTUK: |
|--|--|--|--|
| T. Nosel Bermotor*  | Nosel karpet: - Sikat rol pada nosel bermotor yang berputar dan memberikan sedikit goncangan di atas karpet, memberikan hasil yang sempurna dalam membersihkan dan menghisap debu. - Jangan membiarkan Nosel bermotor serta sikat rol menyala dalam keadaan tidak digunakan. | U. Nosel FlowMotion* V. Nosel LED FlowMotion*  | Nosel universal: - Untuk semua jenis lantai, memastikan debu disedot baik pada karpet maupun lantai keras. - Ganti pengaturan nosel dengan pedal. Ikon akan menunjukkan jenis lantai yang disarankan. - Lampu depan membantu mendeteksi debu dan kotoran di ruang gelap (di bawah meja dll.). <i>Hanya PureVision</i> |
| | | X. Nosel Mini Turbo*  | Nosel pelapis: - Menyikat dan menyedot secara bersamaan (paling baik menyedot rambut, serat, dll.). - Untuk bahan tekstil pada meja, jok mobil, kasur, dll. - Rol sikat digerakkan oleh aliran udara dari penyedot debu. - Tidak cocok untuk karpet yang sangat tebal dan bertepi panjang karena bisa tersangkut dalam rol sikat yang berputar. |
| W. Nosel Turbo*  | Nosel karpet: - Menyikat dan menyedot secara bersamaan (paling baik menyedot rambut, serat, dll.). - Rol sikat digerakkan oleh aliran udara dari penyedot debu. - Tidak cocok untuk karpet yang sangat tebal dan bertepi panjang, karpet anti selip seperti keset pintu atau karpet tahan air. Gunakan nosel universal sebagai gantinya. | Z. Nosel FlexProPlus*  | Nosel Lantai Keras: - Untuk menjangkau tempat di bawah/ di antara meja, sudut, dan pengalang lainnya. - Dapat mudah berputar 180 derajat sehingga dapat langsung menjangkau ruang yang sempit. |
| Y. Nosel ParkettoPro*  | Nosel lantai keras: - Untuk pembersihan lantai keras secara halus (parket, lantai kayu, ubin dll.). - Paling baik menyedot debu yang berada di atas lantai keras yang memiliki celah. | AB. Nosel BedPro*  | Nosel tempat tidur: - Menghilangkan kotoran dan debu dari seprai dan kasur. |
| AA. Nosel celah panjang*  | Alat ekstra panjang: - Untuk area yang sulit dijangkau (rak atas dll.). - Untuk ruang sempit (di balik radiator, di bawah jok mobil dll.). | K. Alat aksesoris 3 in 1*  | 3 alat dalam 1: 1. Alat penyedot debu untuk permukaan keras (rak buku, papan tepi sudut dinding, dll). 2. Alat untuk pelapis tekstil (tirai, pelapis, dll.). 3. Alat untuk celah ruang sempit (di belakang radiator dll.). |

Model dengan pengaturan daya manual
 - ikuti gambar pada pembersih untuk memperoleh kinerja yang optimal.

PEMECAHAN MASALAH

| MASALAH | SOLUSI |
|--|---|
| Penyedot debu tidak bisa menyala | <ul style="list-style-type: none"> • Periksa apakah kabel tersambung ke sumber listrik. • Periksa apakah colokan dan kabel tidak rusak. • Periksa apakah sekering putus. • Periksa apakah lampu indikator baterai dalam remote control merespons (model tertentu saja). |
| Pembersih mati/berhenti berfungsi | Pembersih mungkin terlalu panas: putuskan dari colokan; periksa apakah nosel, tabung, selang atau filter terhalang. Biarkan penyedot agar dingin selama 120 menit sebelum kembali dipasang. Jika pembersih masih tidak berfungsi, hubungi pusat servis resmi Electrolux. |
| Kapasitas hisap dibandingkan normal berkurang | <ul style="list-style-type: none"> • Periksa apakah kompartemen debu penuh atau terhalang. • Periksa apakah saluran udara dan sambungan saluran masuk/inlet atau outlet tersumbat dan perlu dibersihkan. • Periksa apakah filter pra-motor tersumbat dan perlu diganti. • Periksa apakah nosel terhalang dan perlu dibersihkan. • Periksa apakah selang terhalang dengan meremasnya dengan lembut. Namun berhati-hatilah jika sumbatan disebabkan oleh kaca atau jarum yang tersangkut di dalam selang. Perhatikan: Garansi tidak meliputi kerusakan pada selang karena pembersihan. |
| Air tersedot ke dalam penyedot debu | Anda perlu mengganti motor di pusat servis resmi Electrolux. Kerusakan motor karena kemasukan air tidak termasuk di dalam garansi. |
| Untuk masalah lebih lanjut, hubungi pusat servis resmi Electrolux. | |

BARANG SEKALI PAKAI & AKSESORI



Membeli Barang Sekali Pakai & Aksesori untuk perangkat Anda:

www.electroluxshop.co.kr
<https://shop.electrolux.com.au/>

Ketersediaan Barang Sekali Pakai & Aksesori berbeda-beda menurut wilayah dan negara. Silakan lihat di situs web Electrolux setempat kami untuk memperoleh detail lebih lanjut atau hubungi saluran khusus layanan pelanggan setempat untuk memperoleh bantuan.

S-FILTER



PureAdvantage D11 Dapat Dicuci (Australia, Selandia Baru)

HEPA 13 dapat dicuci

S-FRESH



Crispy Bamboo
 Tropical Breeze
 Brown Sugar & Fig
 Evening Rose
 Citrus Burst

NOSEL*



Silent Parketto



DustMagnet Silent

KIT



KIT Delicate Care



KIT Clean & Tidy

* Ketersediaan aksesori bergantung pada dimensi tabung

LAYANAN PELANGGAN DAN SERVIS

Ketika menghubungi bagian Servis, pastikan untuk menyediakan informasi berikut:

- Nomor Model
- Nomor PNC
- Nomor seri

Informasi bisa ditemukan pada pelat informasi.

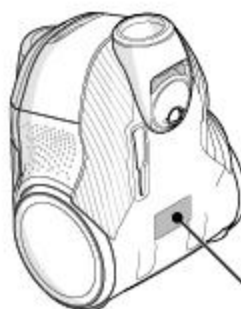

Nomor Model Nomor PNC Nomor Seri

| | | | |
|---|------------------|---------------------|------------------------|
| Electrolux | | | Type FNA |
| Model Code TBD | PNC 910287894 | Et. 00 | Serial No. 12345678 |
| | | 230 V ~ 50 Hz | 550 W NCM |
| | | | Made in (U) |
| <small>Electrolux Appliances AB 51 Gönnarsgatan, 401 86-100 49, Stockholm, Sweden</small> | | | |

KUNJUNGI SITUS WEB KAMI UNTUK:



Mendapatkan informasi pemakaian, brosur,
 Penyelesaian masalah, Informasi servis:
www.electrolux.com

1. ภาพรวมของผลิตภัณฑ์

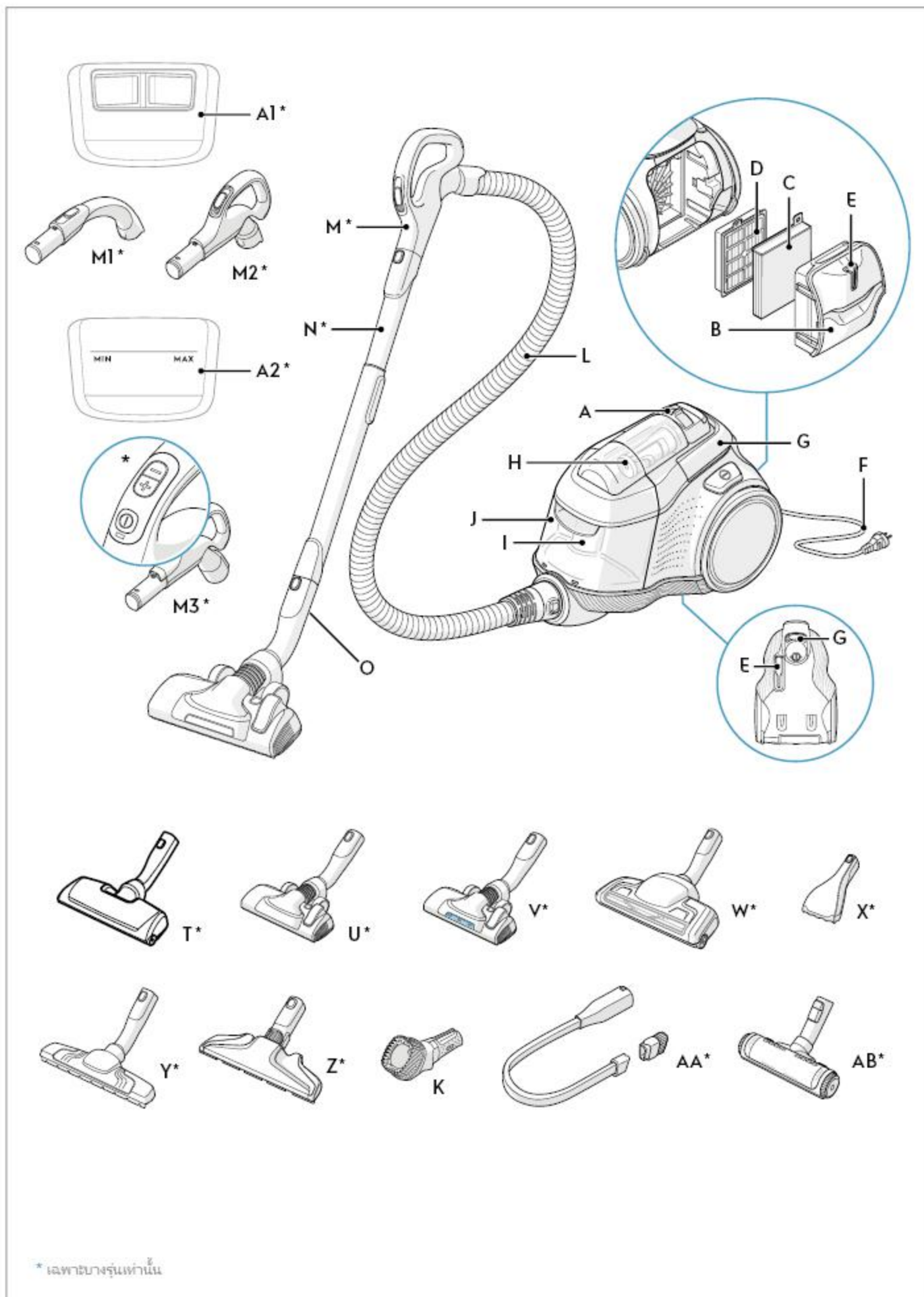

* เฉพาะบางรุ่นเท่านั้น

2. การติดตั้ง

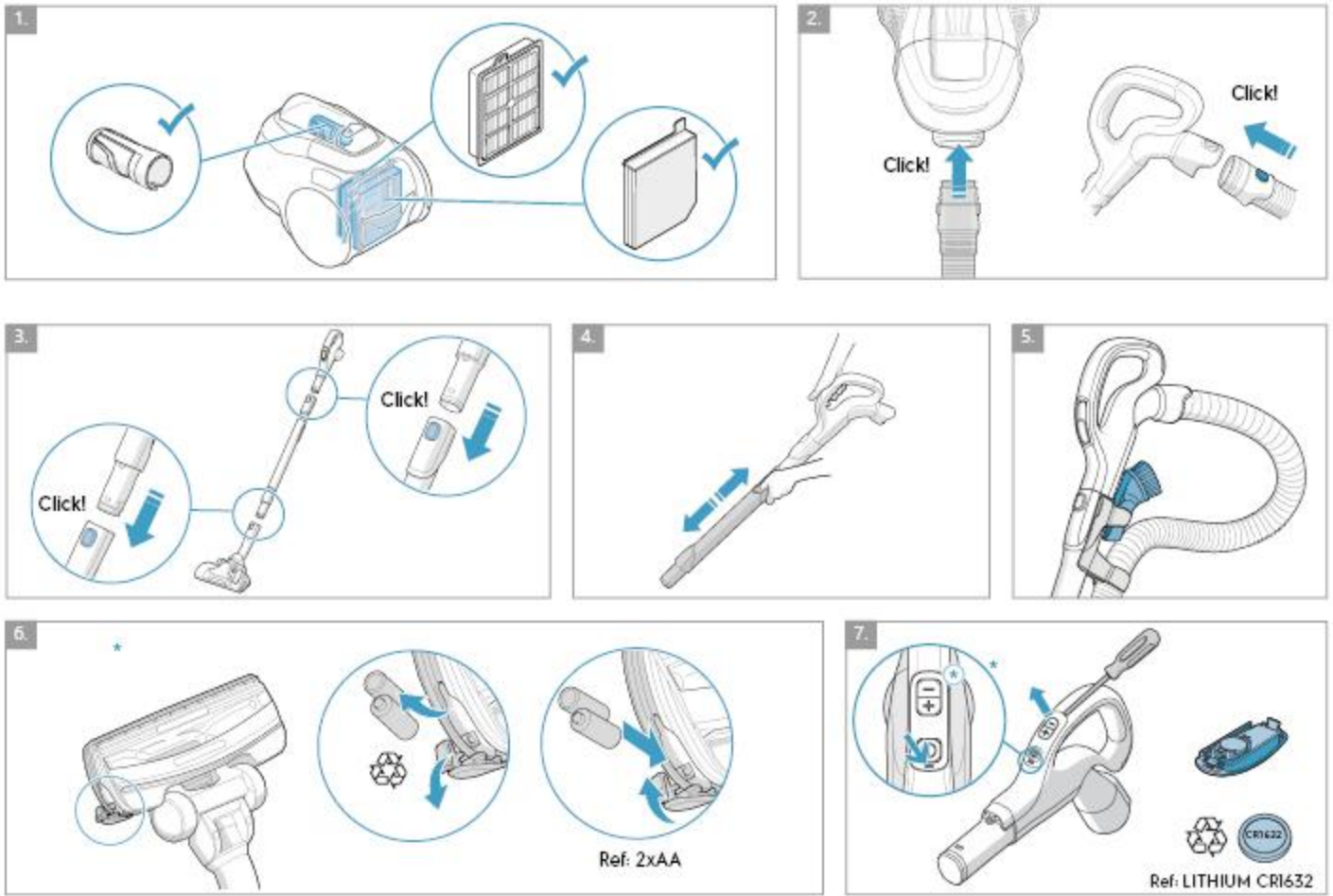

3. การใช้งานผลิตภัณฑ์

* เฉพาะบางรุ่นเท่านั้น

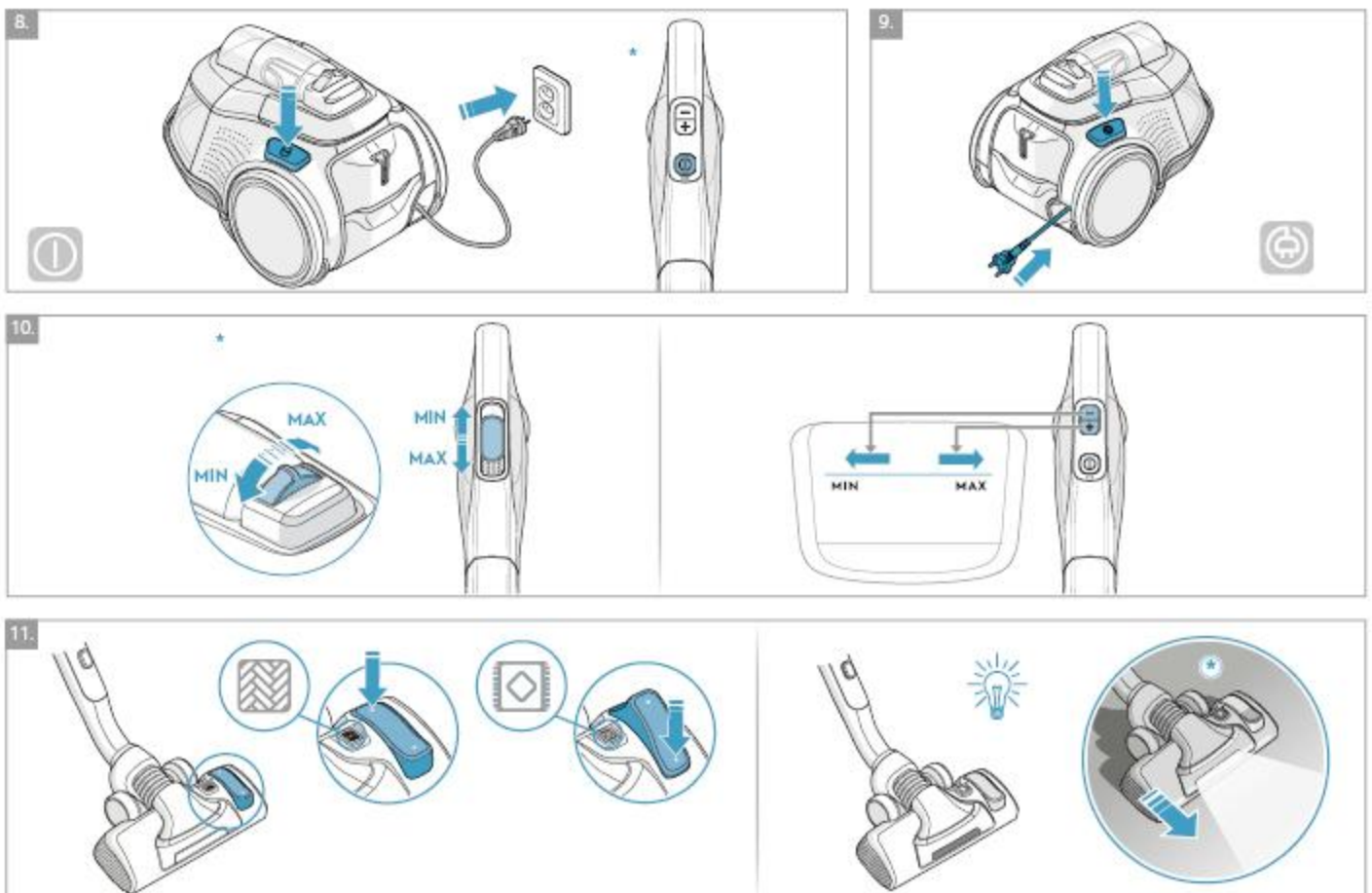

3. การใช้งานผลิตภัณฑ์

* เฉพาะบางรุ่นเท่านั้น

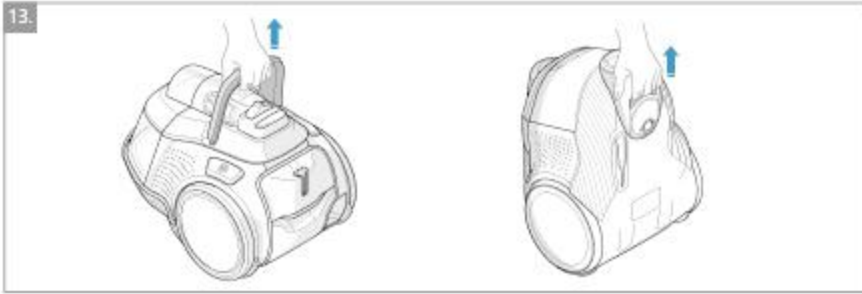
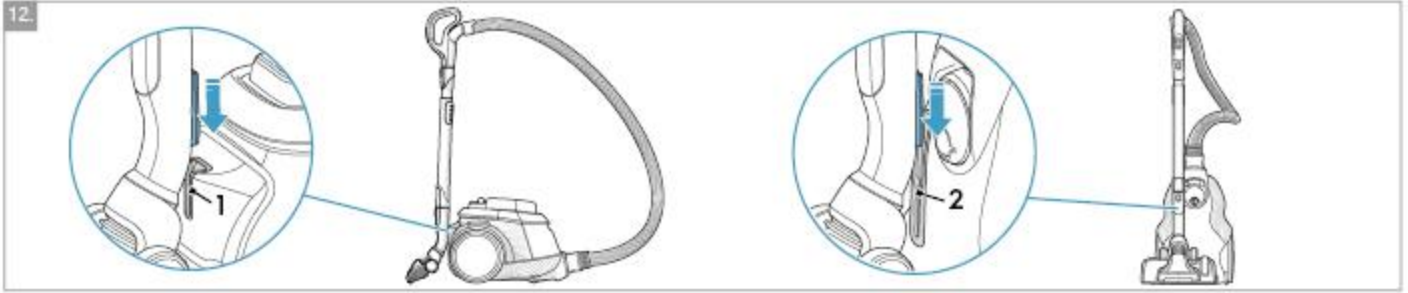

4. การเทฝุ่นทิ้ง

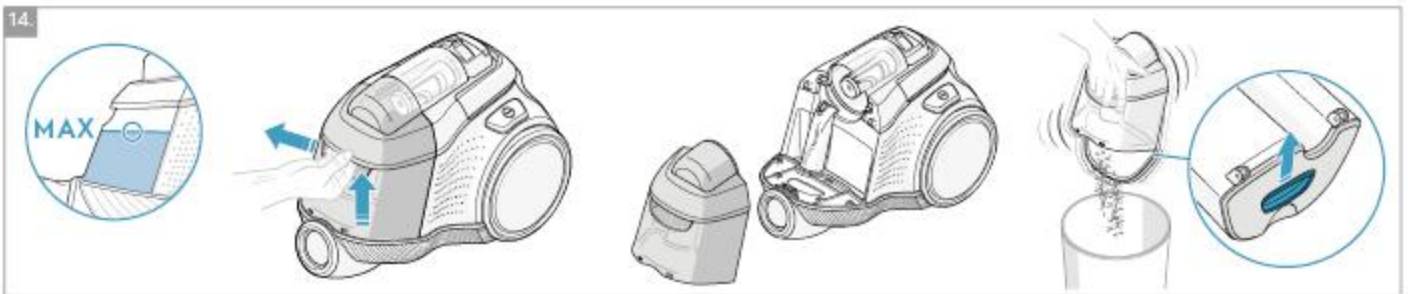

5. การทำความสะอาดตัวกรอง

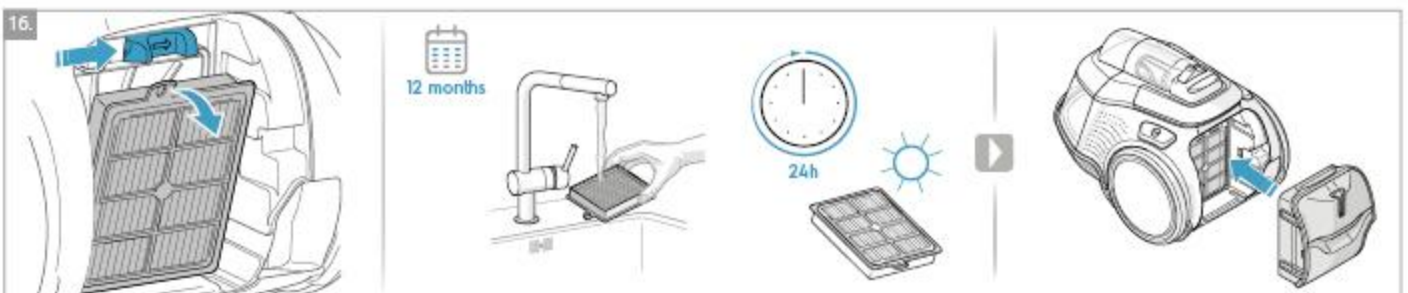
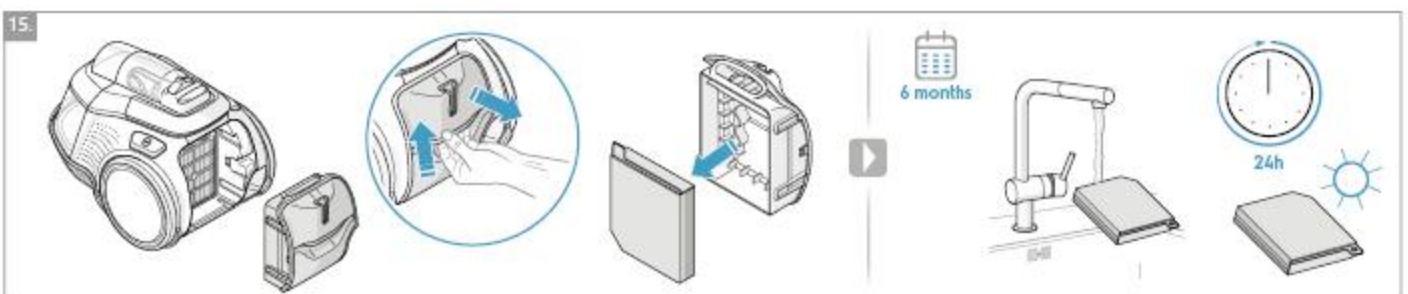

5 การทำความสะอาดตัวกรอง

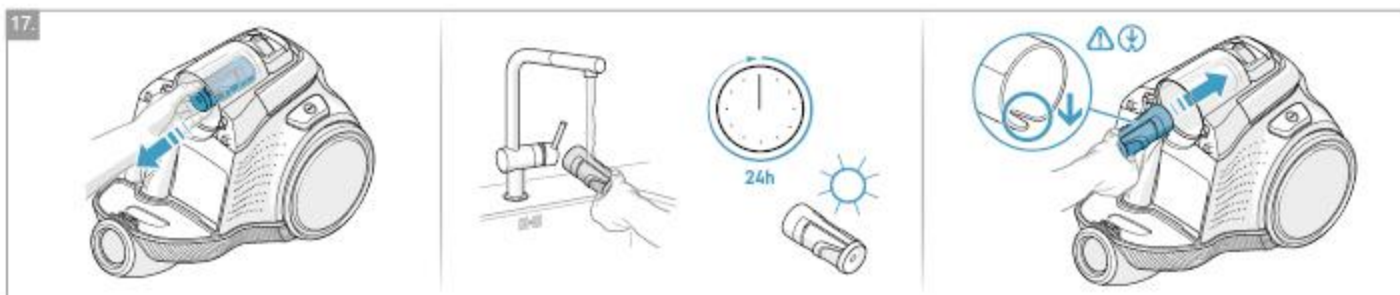

6 การบำรุงรักษา

* เฉพาะบางรุ่นเท่านั้น



7 การตรวจสอบระบบ

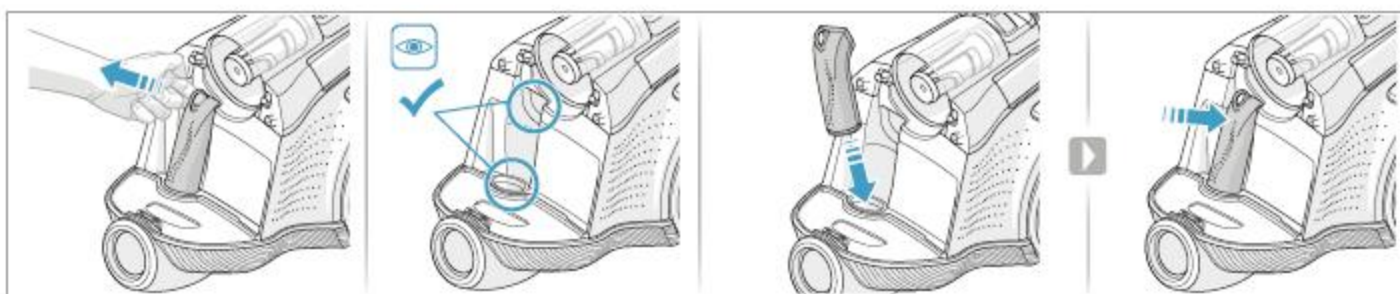
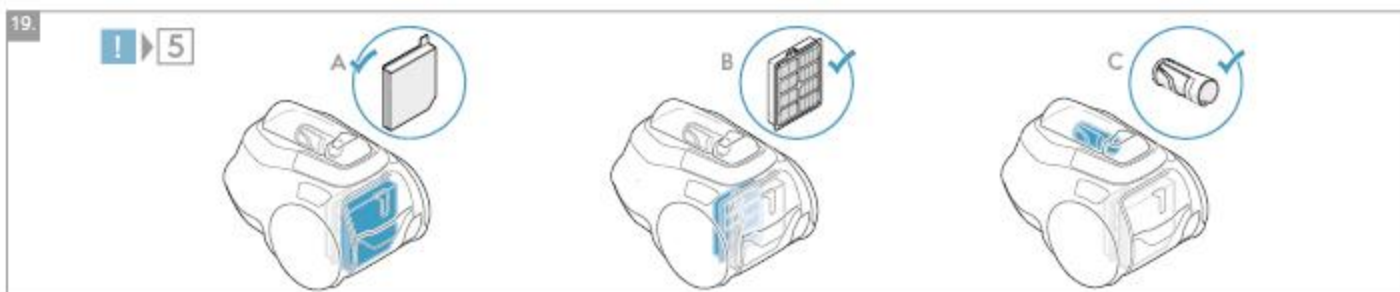

ข้อควรระวังด้านความปลอดภัย

เครื่องสามารถใช้งานได้โดยเด็กอายุ 8 ปีขึ้นไปหรือบุคคลที่มีข้อจำกัดทางร่างกาย ประสาทสัมผัสหรือสภาพจิตใจ หรือขาดประสบการณ์หากมีผู้คอยกำกับดูแลหรือให้คำแนะนำเกี่ยวกับการใช้เครื่องอย่างปลอดภัย และเข้าใจเกี่ยวกับอันตรายที่อาจเกิดขึ้น

เด็กควรได้รับการดูแลเพื่อให้แน่ใจว่าไม่นำเครื่องไปเล่น

การทำความสะอาดและบำรุงรักษา ไม่ควรให้เด็กทำโดยไม่มีกำกับการกำกับดูแล

คำเตือน: ท่อเทอร์โบ * มีแรงแบบหมุนที่ชิ้นส่วนอาจติดค้างอยู่ โปรดใช้งานด้วยความระมัดระวังและใช้เฉพาะบนพื้นผิวที่กำหนดไว้เท่านั้นกรุณาปิดเครื่องดูดฝุ่นก่อนนำชิ้นส่วนที่ติดค้างหรือทำความสะอาดแปร่ง

ต้องถอดแบตเตอรี่ออกจากรีโมทคอนโทรลในที่จับ* / ท่อดูดไฟ LED* ก่อนทิ้ง ผลิตภัณฑ์ **

* เฉพาะบางรุ่นเท่านั้น

** ข้อมูลเกี่ยวกับการถอดแบตเตอรี่อยู่ในหัวข้อ 6 และ 7

ถอดปลั๊กออกจากเต้ารับเสมอ ก่อนทำความสะอาดหรือบำรุงรักษาเครื่อง หรือเมื่อถอดแบตเตอรี่ทิ้งแบตเตอรี่อย่างปลอดภัย หากสายไฟชำรุดเสียหายต้องเปลี่ยนเฉพาะกับศูนย์บริการ Electrolux ที่ได้รับอนุญาตเท่านั้น เพื่อหลีกเลี่ยงอันตราย

Pure C9 ควรใช้เฉพาะสำหรับการดูดฝุ่นภายในและในสภาพแวดล้อมภายในบ้าน เท่านั้นตรวจสอบให้แน่ใจว่าเครื่องดูดฝุ่นถูกเก็บไว้ในที่แห้ง การบริการและการซ่อมแซมทั้งหมดจะต้องดำเนินการโดยศูนย์บริการของ Electrolux วัสดุบรรจุภัณฑ์ เช่น ถุงพลาสติก ควรเก็บไว้ให้พ้นมือเด็ก เพราะอาจทำให้หายใจไม่ออกได้

ห้ามใช้เครื่องดูดฝุ่น:

ในบริเวณที่เปียกชื้น

ใกล้กับก๊าซไวไฟ ฯลฯ

เมื่อตัวเครื่องมีรอยชำรุดเสียหาย

กับของมีคมหรือของเหลว

เมื่อท่อดูดฝุ่นมีรอยชำรุดเสียหายที่เห็นได้ชัดเจน

ดูดชิ้นเก๋าร้อนหรือเย็น กับหลอดไฟ ฯลฯ

ดูดฝุ่นเนื้อละเอียด เช่น จากปูนพลาสเตอร์ คอนกรีต แป้ง ซีเมนต์ร้อนหรือเย็น

อย่าวางเครื่องดูดฝุ่นไว้ในตำแหน่งที่โดนแสงแดดโดยตรง

หลีกเลี่ยงการให้เครื่องดูดฝุ่นสัมผัสความร้อนสูงหรืออุณหภูมิเย็นจัด

ห้ามใช้เครื่องดูดฝุ่นที่ไม่ได้ใส่ตัวกรอง

อย่าพยายามแกะประตูกักสิ่งขุ่นที่เปิดสวิตซ์เครื่องดูดฝุ่นและประตูกักสิ่งก้างกำลัง

หมุน

เมื่อลูกกลิ้งติดขัด

อย่าใช้เครื่องดูดฝุ่นหากตัวกรองเสียหายหรือชำรุด

ข้อควรระวังเกี่ยวกับสายไฟ

ตรวจสอบปลั๊กและสายไฟอย่างสม่ำเสมอห้ามใช้เครื่องดูดฝุ่นที่ปลั๊กหรือสายไฟมีความเสียหาย

ความเสียหายที่เกิดขึ้นกับสายไฟของเครื่องดูดฝุ่นไม่ได้รับการคุ้มครองจากการรับประกัน

อย่าดึงหรือยกเครื่องดูดฝุ่นด้วยการยกสายไฟ

การใช้เครื่องดูดฝุ่นในสถานการณ์ข้างต้นอาจก่อให้เกิดการบาดเจ็บของบุคคลและความเสียหายอย่างรุนแรงต่อผลิตภัณฑ์ความเสียหายดังกล่าวไม่อยู่ภายใต้การรับประกันหรือของ Electrolux

การบริการและการรับประกัน

การบริการและการซ่อมแซมทั้งหมดจะต้องดำเนินการโดยศูนย์บริการของ Electrolux ความเสียหายที่เกิดขึ้นกับสายไฟของเครื่องดูดฝุ่นไม่ได้รับการคุ้มครองจากการรับประกันความเสียหายที่เกิดจากมอเตอร์ โดยการดูดของเหลว เครื่องใช้ในของเหลว หรือใช้เครื่องใช้ไฟฟ้าพร้อมกับท่อ และท่อดูดที่ชำรุด ไม่อยู่ภายใต้การรับประกัน

การกำจัดทิ้ง



สัญลักษณ์นี้แสดงว่าผลิตภัณฑ์ไม่มีแบตเตอรี่ที่สามารถชาร์จใหม่ได้ ซึ่งจะไม่ถูกทิ้งร่วมกับขยะในครัวเรือนทั่วไป



สัญลักษณ์นี้บ่งชี้ผลิตภัณฑ์หรือบรรจุภัณฑ์ที่ผลิตจากพลาสติกที่อาจไม่ถือเป็นขยะจากครัวเรือน

หากต้องการรีไซเคิลผลิตภัณฑ์ของคุณ โปรดนำไปที่จุดทิ้งขยะอย่างเป็นทางการหรือที่ศูนย์บริการ Electrolux ซึ่งสามารถถอดและนำแบตเตอรี่ และชิ้นส่วนไฟฟ้ากลับมาใช้ใหม่ได้อย่างปลอดภัยและเป็นมืออาชีพปฏิบัติตามกฎหมายของประเทศของคุณในตัดแยกขยะจากผลิตภัณฑ์ไฟฟ้าและแบตเตอรี่แบบชาร์จได้

ณ ที่นี้ Electrolux Home Care และ SDA ประกาศว่าเครื่องดูดฝุ่นพร้อมกับอุปกรณ์วิทยุประเภท FOR1, FOR2 และ FOR3 สอดคล้องไปตาม Directive 2014/53/EU

อังกฤษ

ขอขอบคุณที่เลือก Electrolux Pure C9 เครื่องดูดฝุ่นใช้อุปกรณ์เสริมและขอให้สมอบเพื่อทำให้ผลิตภัณฑ์ที่ดีที่สุดผลิตภัณฑ์ได้รับการออกแบบโดยคำนึงถึงสิ่งแวดล้อมชิ้นส่วนพลาสติกทั้งหมดมีเครื่องหมายสำหรับการรีไซเคิล

ก่อนเริ่ม

- อ่านคู่มือฉบับนี้อย่างละเอียด
- ตรวจสอบให้แน่ใจว่ามีชิ้นส่วนประกอบทั้งหมดอยู่ครบถ้วน
- ให้ความใส่ใจเป็นพิเศษเพื่อความปลอดภัย!

คำอธิบายสำหรับเครื่องดูดฝุ่น PURE C9

- | | |
|-----------------------------------|---|
| A. แสดงผล | อุปกรณ์เสริมต่อ |
| A1 ปุ่มควบคุมโรตารี* | K. เครื่องมือ AeroPro 3in1 |
| A2 รีโมทคอนโทรล* | T. หัวดูดมอเตอร์* |
| B. ฝาปิดตัวกรอง | U. หัวแบบ FlowMotion* |
| C. ตัวกรองฝุ่นละเอียด | V. หัวแบบ FlowMotion LED (พร้อมตัวไฟสำหรับส่องสว่าง)* |
| D. ตัวกรองก่อนมอเตอร์ | W. หัวดูด AeroPro Turbo* |
| E. ช่องยึดจับ | X. หัวดูด AeroPro Mini Turbo* |
| F. สายไฟ | Y. หัวดูดแบบ ParkettoPro* |
| G. ที่จับ | Z. หัวดูด AeroPro FlexProPlus* |
| H. ช่องใส่ฟิล์มและตัวกรองรูปกรวย | AA. หัวดูด AeroPro ขนาดยาว* |
| I. ช่องระบายอากาศ | AB. หัวดูด BedPro* |
| J. ที่เก็บฝุ่น | |
| L. หัว AeroPro | |
| M. ที่จับ AeroPro | |
| M1 ที่จับ AeroPro Classic* | *เฉพาะบางรุ่นเท่านั้น |
| M2 ที่จับ AeroPro Ergo* | |
| M3 ที่จับ AeroPro Remote Control* | |
| N. หัวยึด AeroPro | |
| O. ดับเบิ้ล | |

รูปภาพ หน้า 2-6

วิธีใช้เครื่องดูดฝุ่น

- 1 ตรวจสอบว่าตัวกรองถูกใส่ไว้อย่างถูกต้องก่อนที่จะใช้เครื่องดูดฝุ่น
- 2 ใส่สายยางเข้าไปในตัวเครื่องดูดฝุ่น (เมื่อต้องการถอดออกให้กดปุ่มปลดและดึง) ใส่สายยางเข้ากับจับบนกระดิ่งปุ่มปลดติดตั้ง (เพื่อปลดล็อค ให้กดปุ่มปลดและดึง)
- 3 ใส่หัวยึดเข้ากับหัวดูดใส่หัวยึดเข้าไปในตัวเครื่องดูดฝุ่น (เมื่อต้องการถอดออกให้กดปุ่มปลดและดึง)
- 4 ปรับหัวยึดด้วยการจับล็อคด้วยมือข้างหนึ่งและดึงที่จับด้วยมืออีกข้างหนึ่ง

อุปกรณ์เสริม 3IN1

- 5 คุณสามารถยึดด้ามจับยึดและเครื่องมือ 3in1 ไว้ที่ด้ามจับเพื่อให้สามารถเข้าถึงได้ง่าย เครื่องมือมี 3 ฟังก์ชัน ดูภาพเพิ่มเติมที่ต่อไป

การเปลี่ยนแบตเตอรี่*

- 6 หัวดูดพร้อมไฟหน้า* ก่อนใช้งานครั้งแรกให้ถอดฟิล์มป้องกันออก (ด้านบนของแบตเตอรี่) เปลี่ยนแบตเตอรี่เมื่อไฟหน้าเริ่มกะพริบที่ใช้งานขนาด AA 2 ก้อน
 - 7 จัดการกับรีโมทคอนโทรล* เปลี่ยนแบตเตอรี่เมื่อไฟแสดงสถานะเป็นสีแดงหรือไม่มีการตอบสนองเมื่อกดปุ่มเปิด ใช้เฉพาะแบตเตอรี่ชนิด LITHIUM CR1632 เท่านั้น
- หมายเหตุ: ถอดแบตเตอรี่ออกจากเครื่องก่อนทิ้งปฏิบัติตามกฎของประเภทย่อยของคุณในการเก็บแบตเตอรี่และผลิตภัณฑ์ไฟฟ้า

เริ่ม/หยุดเครื่องดูดฝุ่นและปรับกำลังดูด

- 8 ดึงสายไฟและเสียบเข้ากับปลั๊กไฟกดปุ่มเปิด/ปิดเพื่อเปิด/ปิดเครื่องดูดฝุ่นรุ่นที่มีรีโมทคอนโทรลสามารถสั่งการด้วยปุ่มเปิด/ปิดบนที่จับ *
- 9 หลังจากทำความสะอาดแล้วให้กดปุ่ม REWIND เพื่อดึงสายเคเบิลกลับคืน
- 10 ปรับแรงดูด (แบบควบคุมด้วยตนเอง): หมุนปุ่มโรตารีบนเครื่องดูดฝุ่นหรือใช้วาสิคัมที่มีมือจับ*
ปรับแรงดูด (แบบควบคุมด้วยรีโมทคอนโทรล): กดปุ่ม +/- บนที่จับ สัญญาณ MIN/MAX และสัญญาณที่แสดงบนจอแสดงผลระดับกำลัง*

การดูดฝุ่นด้วยหัวดูดทั่วไป (V*, W*)

- 11 เปลี่ยนหัวดูดด้วยคันเหยียบไอคอนจะแสดงประเภทของพื้นที่แนะนำ (พื้นแข็งหรือพรม).
หัวแบบ FlowMotion LED* เลื่อนหัวดูดไปข้างหน้าไฟหน้าจะปิดขึ้นโดยอัตโนมัติหลังจากผ่านไป
สัปดาห์เมื่อใช้หัวดูด ไฟจะดับลงโดยอัตโนมัติภายในไม่กี่วินาที

ตำแหน่งการหยุดเครื่องการเคลื่อนที่เครื่องดูดฝุ่น

- 12 ใช้ตำแหน่งที่หยุดเครื่อง (1) ที่ด้านหลังของเครื่องดูดฝุ่น เมื่อคุณหยุดพักชั่วคราวในขณะดูดฝุ่นใช้ตำแหน่งช่องยึดจับ (2) ใต้เครื่องดูดฝุ่น เพื่อหาลงและเก็บเครื่องดูดฝุ่น
- 13 เครื่องดูดฝุ่นมีมือจับ 2 แบบ

การเพิ่มพลัง

- 14 หมุนที่เก็บฝุ่นทั้งหมด เมื่อระดับฝุ่นถึงขีดจำกัดสูงสุด (เครื่องหมาย "MAX") กดปุ่มปลดล็อคและดึงออกเพื่อถอดที่เก็บฝุ่นออก
ถือที่เก็บฝุ่นไว้เหนือถังขยะกดปุ่มปลดล็อคได้เปิด เปิดฝาโดยเลื่อนออกด้านนอก หมุนลงถังขยะนำกลับคืนเข้าที่โดยทำตามลำดับย้อนกลับ

เปลี่ยนตัวกรอง

- 15 ดึงปุ่ม FILTER เพื่อเปิดฝาดรอป
ทำความสะอาดแผ่นกรองฝุ่นหลังจากใช้งานนานหกเดือน หรือเมื่อมองเห็นฝุ่นถึงแถบบนเฟรมเพื่อถอดตัวกรองฝุ่นและของจากตัวกรองโดยเปิดฝาดรอป
หมายเหตุ: อย่าใช้สารทำความสะอาดปล่อยให้ตัวกรองแห้งสนิท (อย่างน้อย 24 ชั่วโมงในอุณหภูมิห้อง) ก่อนที่จะนำกลับมาใช้คืน!
- 16 กดและเลื่อนกลิ้งล็อคไปทางขวาเพื่อปลด
ตัวกรองก่อนมอเตอร์นำตัวกรองออกโดยดึงแถบตัวกรอง
ทำความสะอาดตัวกรองก่อนมอเตอร์หลังจากใช้งานนาน 12 เดือน
แนะนำให้ใช้เฉพาะ s-filter หรือที่แนะนำโดย Electrolux (ดูที่วัสดุสิ้นเปลืองและอุปกรณ์เสริม)
ล้างตัวกรอง (ด้านที่สกปรก) ในน้ำประปาอุ่น ๆ และที่กรองตัวกรองเพื่อใช้ได้อีก
ห้าชั่วโมงก่อนเสด็จ

หมายเหตุ: อย่าใช้สารทำความสะอาดหลีกเลี่ยงการสัมผัสพื้นผิวของตัวกรองปล่อยให้ตัวกรองแห้งสนิท (อย่างน้อย 24 ชั่วโมงในอุณหภูมิห้อง) ก่อนที่จะนำกลับมาใช้คืน! เปลี่ยนไส้กรองอย่างน้อยปีละครั้งหรือเมื่อสกปรกหรือเสียหายมาก

หลังจากเปลี่ยนตัวกรองปิดฝาดรอปตัวกรองจนกว่าจะมีการคลิกเข้าที่









- 17 การทำความสะอาดตัวกรองรูปกรวย:
ตัวกรองรูปกรวยอยู่ในช่องใส่ฟิล์มทำความสะอาดตัวกรองรูปกรวย หากมีฝุ่นเข้าไปในตัวกรองรูปกรวยออกกำจัดด้วยมือของคุณ หากมีตราสกปรกมากให้ทำความสะอาดโดยปล่อยให้น้ำไหลผ่าน นำกลับคืนเข้าที่โดยทำตามลำดับย้อนกลับ
หมายเหตุ: อย่าใช้สารทำความสะอาดปล่อยให้ตัวกรองแห้งสนิท (อย่างน้อย 24 ชั่วโมงในอุณหภูมิห้อง) ก่อนที่จะนำกลับมาใช้คืน!

การทำความสะอาดหัวดูดทั่วไป (V*, W**) และหัวดูดเทอร์โบ (X*)

- 18 ถอดหัวดูดทั่วไป ออกทำความสะอาดด้วยมือจับ
ถอดหัวดูดเทอร์โบ จากหัวและกำจัดด้วยที่พันกัน ฯลฯ โดยการตัดออกด้วยกรรไกร ใช้ที่จับเพื่อทำความสะอาดหัวดูด*

ผลิตภัณฑ์ไม่กับประสบการณ์การทำทำความสะอาดที่อดเยี่ยมด้วย Pure C9!

Electrolux ขอสงวนสิทธิ์ในการเปลี่ยนแปลงข้อมูลผลิตภัณฑ์และข้อมูลเฉพาะ โดยไม่ต้องแจ้งให้ทราบล่วงหน้า

| ชื่อ/อุปกรณ์เสริม | ใช้สำหรับ: | ชื่อ/อุปกรณ์เสริม | ใช้สำหรับ: |
|--|---|--|--|
| T. หัวดูดมอเตอร์*  | ถอดสำหรับพรม: - หัวดูดมอเตอร์ช่วยดูดฝุ่นได้ดีที่สุด และทำตามคำแนะนำได้อย่างมีประสิทธิภาพและปลอดภัย - จุ่มหัวดูดมอเตอร์ที่บริเวณเปิดประตูกลิ้งอยู่ | U. หัวดูด FlowMotion* V. หัวดูด FlowMotion LED*  | ถอดหัวปู: - สำหรับพื้นทุกประเภท โดยจะเก็บฝุ่นได้ดีที่สุดทั้งบนพรมและพื้นแข็ง - เปลี่ยนหัวดูดด้วยคันเหยียบไอคอนจะแสดงประเภทของพื้นเห็นหน้า - แสงไฟด้านหลังช่วยในการตรวจจับฝุ่นและสิ่งสกปรกในเม็ด (เช่น ใต้เฟอร์นิเจอร์ เป็นต้น) เฉพาะรุ่น PureVision เท่านั้น |
| W. หัวดูดเทอร์โบ*  | ถอดสำหรับพรม: - แปรและดูดฝุ่นในเวลาเดียวกัน (เหมาะที่สุดสำหรับดูดเส้นผม, เส้นใย ฯลฯ) - ลูกกลิ้งแปรงจะถูกับเครื่องดูดฝุ่นของอากาศของเครื่องดูดฝุ่น - ไม่เหมาะสำหรับพรมที่มีขนพรมหนาและขอบยาว, พรมกันลื่น เช่น พรมเช็ดเท้าหรือพรมกันน้ำใช้ถอดหัวปูแทน | X. หัวดูดเทอร์โบแบบมินิ*  | ถอดสำหรับผ้า เสื่อ: - แปรและดูดฝุ่นในเวลาเดียวกัน (เหมาะที่สุดสำหรับดูดเส้นผม, เส้นใย ฯลฯ) - สำหรับสิ่งสกปรกตามเฟอร์นิเจอร์, เบาะนั่งรถยนต์, ที่นอน ฯลฯ - ลูกกลิ้งแปรงจะถูกับเครื่องดูดฝุ่นของอากาศของเครื่องดูดฝุ่น - ไม่เหมาะสำหรับพรมที่มีขนพรมหนาและขอบยาว เนื่องจากจะติดพันกันอยู่ในลูกกลิ้งแปรง |
| Y. หัวดูดแบบ ParkettoPro*  | ถอดสำหรับพรม: - สำหรับทำความสะอาดอย่างนุ่มนวลสำหรับพรมแข็ง (ไม้ปาร์เก้, พรมไม้, กระเบื้อง ฯลฯ) - ดูดฝุ่นได้ดีบนพรมแข็งที่มีรอยแตก. | Z. หัวดูดแบบ FlexProPlus*  | ถอดสำหรับพรมแข็ง: - เพื่อหลีกเลี่ยงเข้าไปใต้/ระหว่างเฟอร์นิเจอร์และสิ่งกีดขวางอื่น ๆ - สามารถหมุนได้ 180 องศาโดยง่าย สำหรับการเข้าถึงช่องว่างแคบ ๆ |
| AA. หัวดูดขนาดยาว*  | เครื่องมือที่ยาวเป็นพิเศษ: - สำหรับพื้นที่ที่ยากต่อการเข้าถึง (ด้านบนของชั้นวาง ฯลฯ) - สำหรับพื้นที่แคบ (หลังหมอน, ใต้ที่นั่ง ฯลฯ) | AB. หัวดูด BedPro*  | ถอดสำหรับเตียง* - ขจัดสิ่งสกปรกและไรฝุ่นออกจากเตียงนอนและผ้าปูที่นอน |
| K. อุปกรณ์เสริม 3in1*  | | | เครื่องมือ 3 แบบใน 1: 1. สำหรับดูดฝุ่นบนพื้นผิวแข็ง (เช่น ผนัง, ฝ้าเพดาน ฯลฯ) 2. สำหรับดูดฝุ่นตามสิ่งทอ (ผ้าปูที่นอน, เบาะรถ ฯลฯ) 3. สำหรับดูดฝุ่นตามร่อง รอยแยก (หลังหมอน, ราวบันได ฯลฯ) |

รุ่นที่มีการควบคุมกำลังด้วยมือ
 - ปฏิบัติต่อเครื่องดูดฝุ่นตามภาพกราฟิกเพื่อประสิทธิภาพที่ดีที่สุด

การแก้ไขปัญหา

| ปัญหา | การแก้ไข |
|--|---|
| เครื่องดูดฝุ่นไม่เริ่มทำงาน | <ul style="list-style-type: none"> • ตรวจสอบสายไฟเสียบปลั๊กไฟหรือไม่ • ตรวจสอบว่าปลั๊กและสายไฟไม่มีความเสียหาย • ตรวจสอบว่าฟิวส์ขาดหรือไม่ • ตรวจสอบว่าไฟแสดงสถานะบนตัวเครื่องในที่จับหีโรหรือหลอดไฟแสดงสถานะหรือไม่ (มีเฉพาะบางรุ่นเท่านั้น) |
| เครื่องดูดฝุ่นหยุดทำงาน | เครื่องอาจเกิดความร้อนสูงเกินไป: ถอดสายไฟออก ตรวจสอบว่าท่อ สายยางหรือตัวกรองอุดตันหรือไม่ที่หัวตัวเครื่องเป็นเวลานาน 120 นาทีก่อนเสียบปลั๊กอีกครั้ง หากเครื่องยังไม่ทำงาน ให้ติดต่อศูนย์บริการที่ได้รับอนุญาตจาก Electrolux |
| การดูดอ่อนกำลังลงเมื่อเทียบกับปกติ | <ul style="list-style-type: none"> • ตรวจสอบว่าเก็บฝุ่น เต็มหรืออุดตันหรือไม่ • ตรวจสอบว่าช่องระบายอากาศและช่องทางเข้าหรือออกอุดตันและจำเป็นต้องทำความสะอาดหรือไม่ • ตรวจสอบว่ามีสารอุดตันของตัวกรองก่อนเข้ามอเตอร์และจำเป็นต้องเปลี่ยนหรือไม่ • ตรวจสอบว่าหัวดูดมีการอุดตันและจำเป็นต้องทำความสะอาดหรือไม่ • ตรวจสอบว่าท่อสายยางอุดตันหรือไม่ โดยบีบเบา ๆ อย่าวางมือที่บริเวณมอเตอร์ในกรณีที่เกิดการอุดตันจากแก้วหรือเข็มที่ติดอยู่ภายในท่อ หมายเหตุ: การรับประกันไม่ครอบคลุมถึงความเสียหายที่เกิดจากการทำความสะอาดท่อดูด |
| น้ำถูกดูดเข้าไปในเครื่องดูดฝุ่น | จำเป็นต้องเปลี่ยนมอเตอร์กับศูนย์บริการ Electrolux ที่ได้รับอนุญาต ความเสียหายของมอเตอร์เนื่องจากโดนน้ำ ไม่ครอบคลุมโดยการรับประกันผลิตภัณฑ์ |
| หากมีข้อมูลเพิ่มเติมโปรดติดต่อศูนย์บริการ Electrolux ที่ได้รับอนุญาต | |

วัสดุสิ้นเปลืองและอุปกรณ์เสริม



ซื้อวัสดุสิ้นเปลืองและอุปกรณ์เสริม
สำหรับเครื่องใช้ของคุณ

www.electroluxshop.co.kr
<https://shop.electrolux.com.au/>

ความพร้อมให้บริการของวัสดุสิ้นเปลืองและอุปกรณ์เสริมแตกต่างกันไปตามภูมิภาคและประเทศ
โปรดดูรายละเอียดเพิ่มเติมได้จากเว็บไซต์ Electrolux ในพื้นที่ของเราหรือติดต่อสายด่วนบริการลูกค้าท้องถิ่นเพื่อขอรับบริการ

S-FILTER



PureAdvantage D11 Washable
(ออสเตเรีย, นิวซีแลนด์)

HEPA 13 washable

S-FRESH



Crispy Bamboo
Tropical Breeze
Brown Sugar & Fig
Evening Rose
Citrus Burst

ท่อดูด*



Silent Parketto



DustMagnet Silent

ชุดอุปกรณ์



Delicate Care KIT



Clean & Tidy KIT

* ความพร้อมใช้งานของอุปกรณ์เสริมขึ้นอยู่กับขนาดของท่อ

ฝ่ายบริการและดูแลลูกค้า

ในการติดต่อฝ่ายบริการ ตรวจสอบให้แน่ใจว่าคุณมีข้อมูลต่อไปนี้

- หมายเลขรุ่น
- หมายเลข PNC
- หมายเลขซีเรียล

ข้อมูลนี้จะอยู่บนแผ่นป้ายของเครื่อง

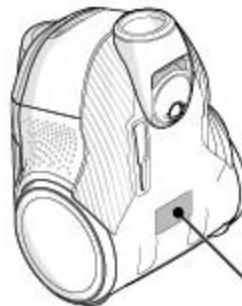

| หมายเลขรุ่น | หมายเลข PNC | หมายเลขเครื่อง |
|---|-------------|----------------|
| | | |
| Model Code | PNC | Serial No. |
| TBD | 910287894 | 00 12345678 |
| | | |
| 230 V | | 550 W NCM |
| 50 Hz | | Made in (U) |
| | | |
| Electrolux Appliance AB S-1 Downrigatan, Inc. SE-105 45 Stockholm, Sweden | | |

เยี่ยมชมเว็บไซต์ของเราเพื่อ:



รับคำแนะนำจากช่าง, โพรซัวร์,
นักโศภนุหา, ข้อมูลการบริการ
www.electrolux.com

1. TỔNG QUAN VỀ SẢN PHẨM

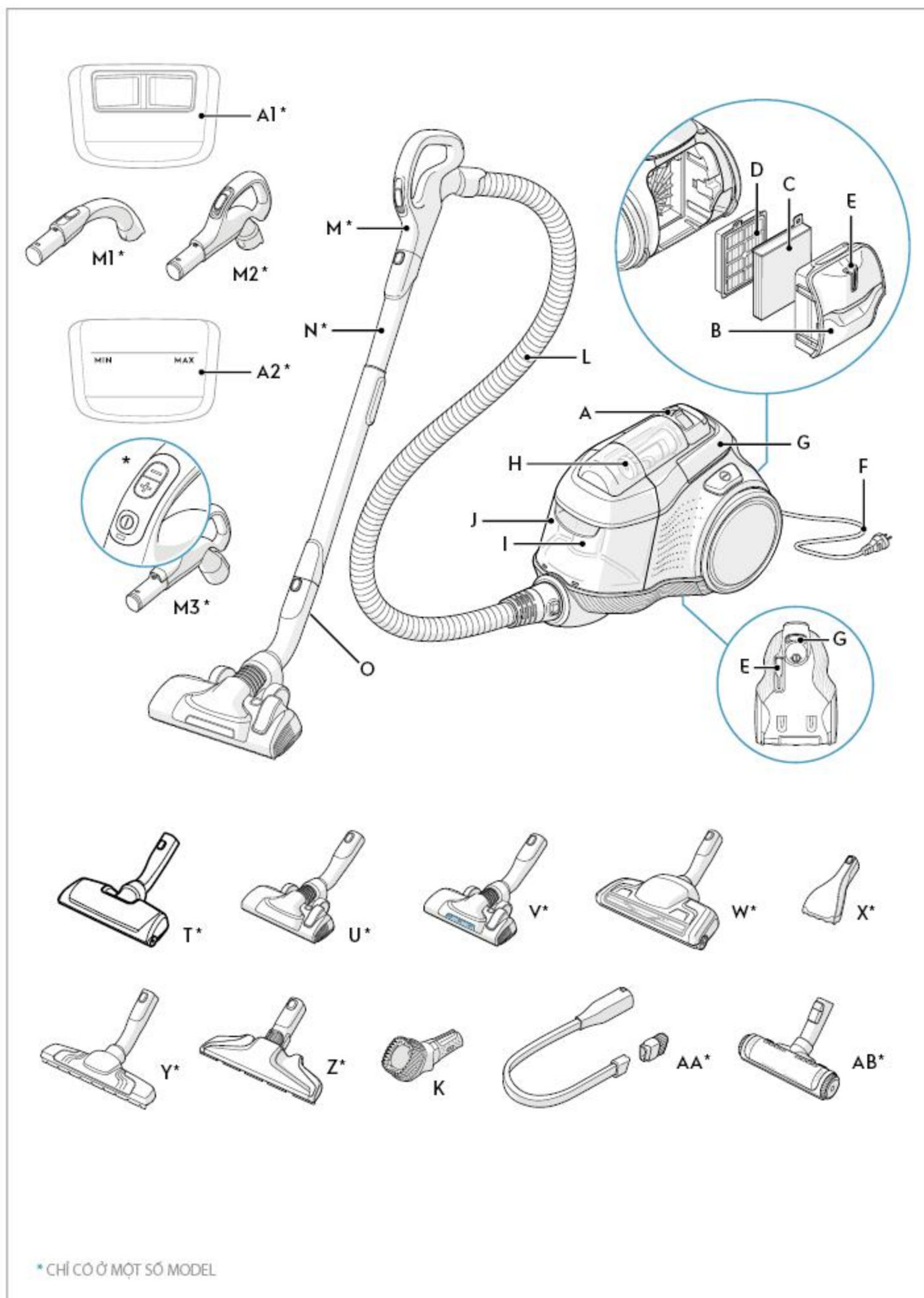

* CHỈ CÓ Ở MỘT SỐ MODEL

2. LẮP ĐẶT

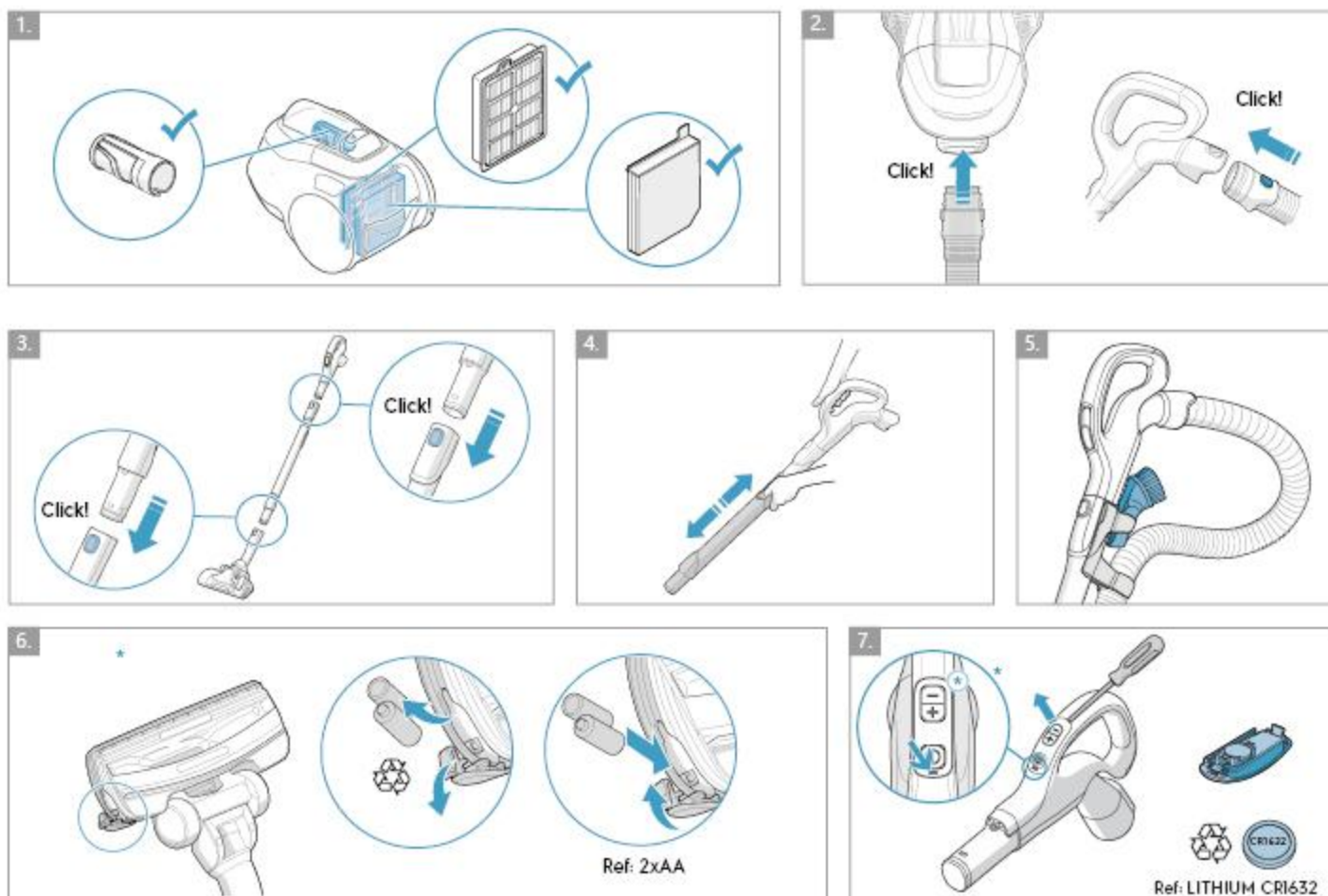

3. SỬ DỤNG SẢN PHẨM

* CHỈ CÓ Ở MỘT SỐ MODEL

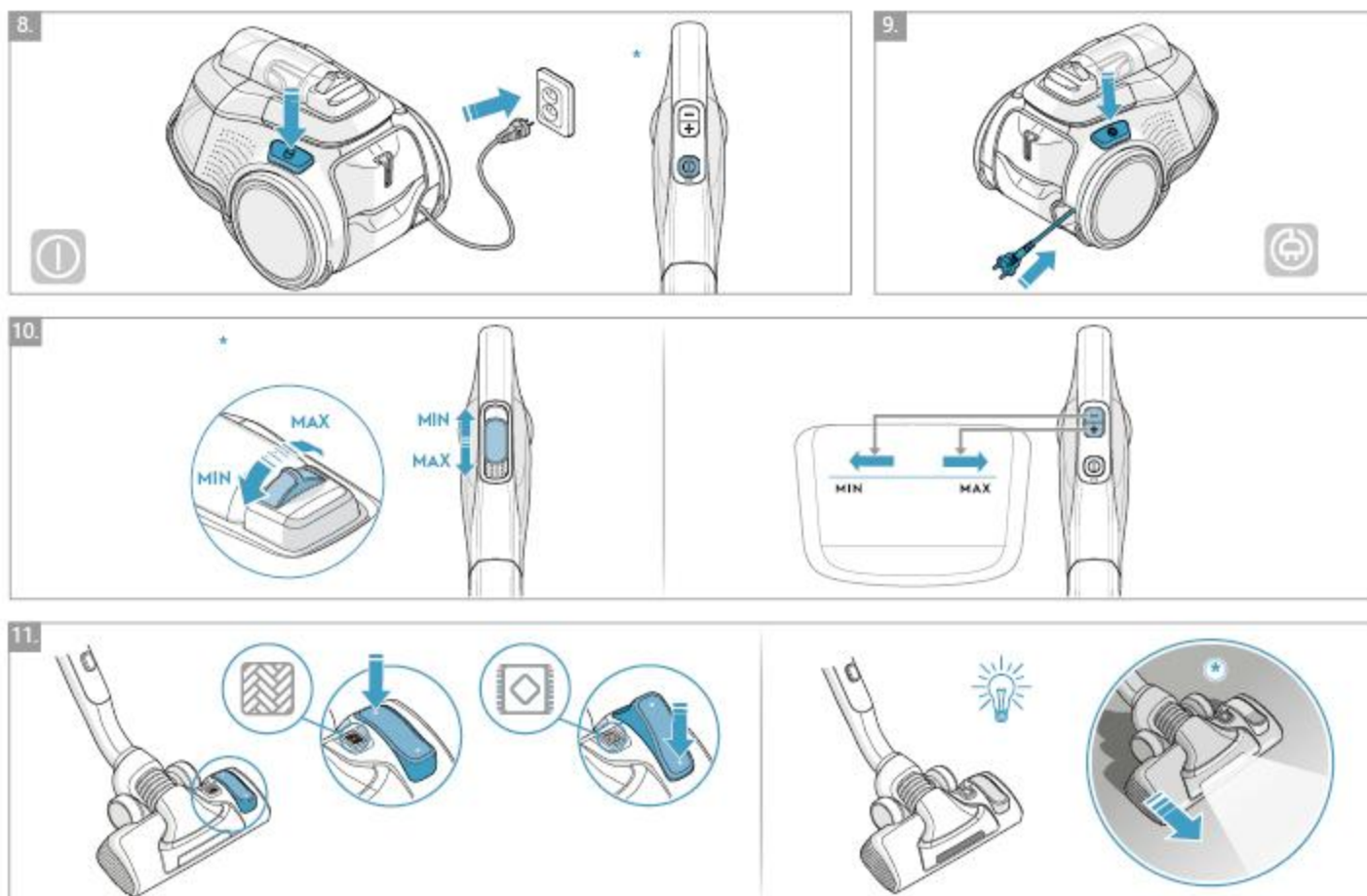

3. SỬ DỤNG SẢN PHẨM

* CHỈ CÓ Ở MỘT SỐ MODEL

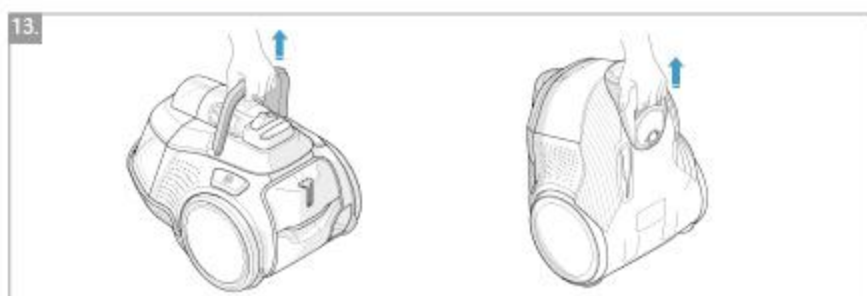
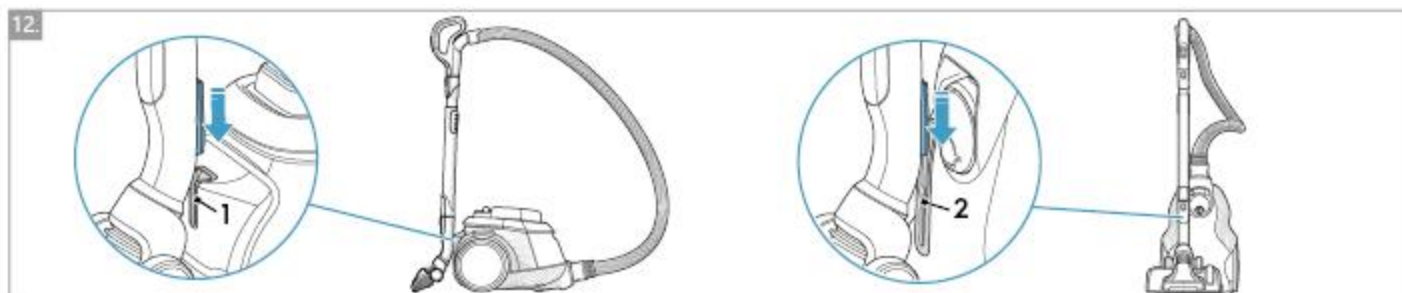

4. LOẠI BỎ BỤI BẨN

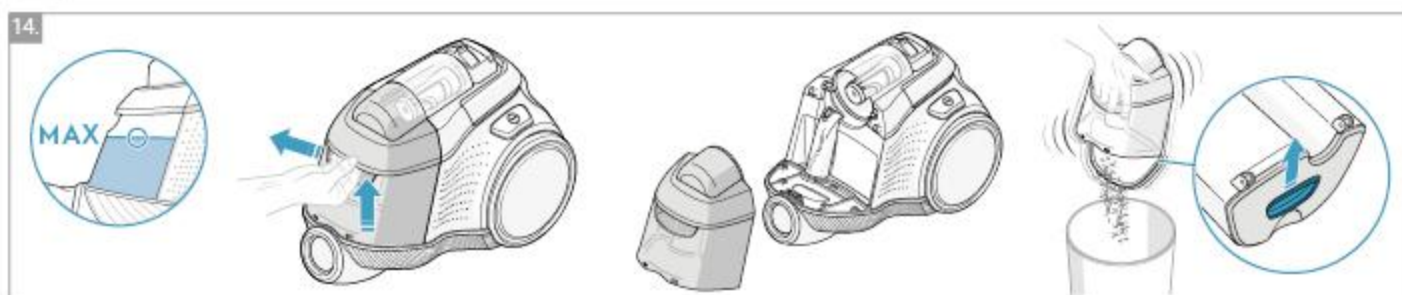

5. VỆ SINH MÀNG LỌC

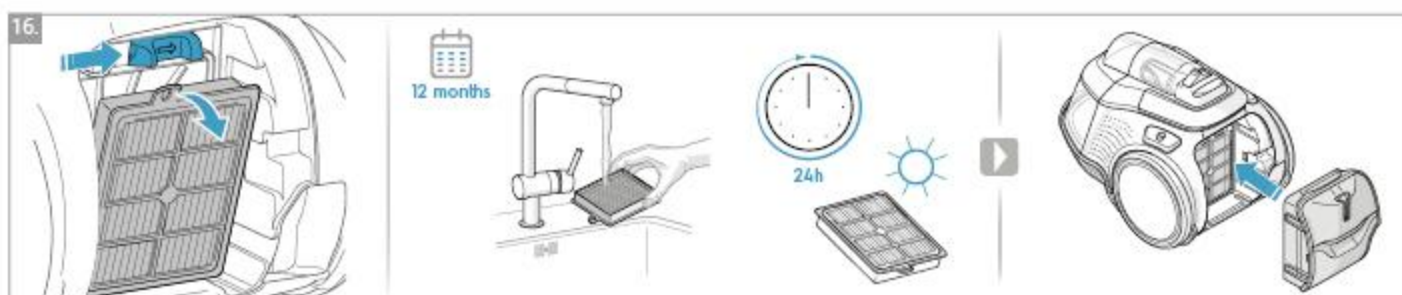
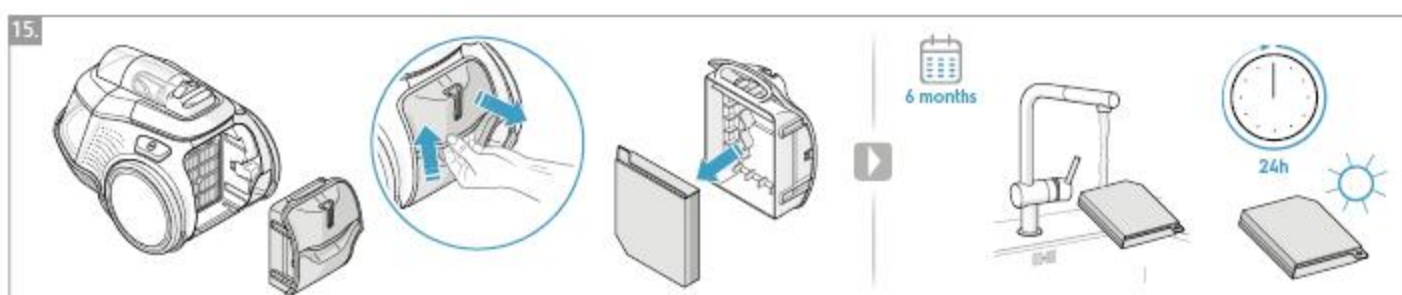

5. VỆ SINH MÀNG LỌC

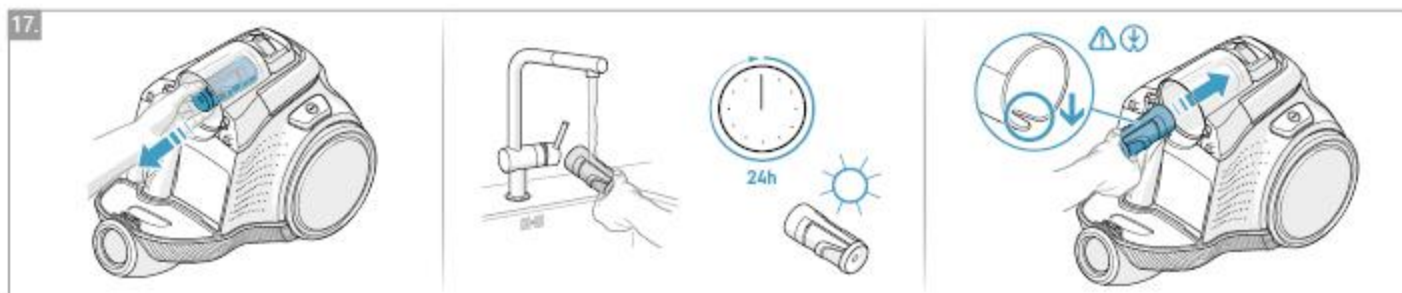

6. BẢO TRÌ

* CHỈ CÓ Ở MỘT SỐ MODEL

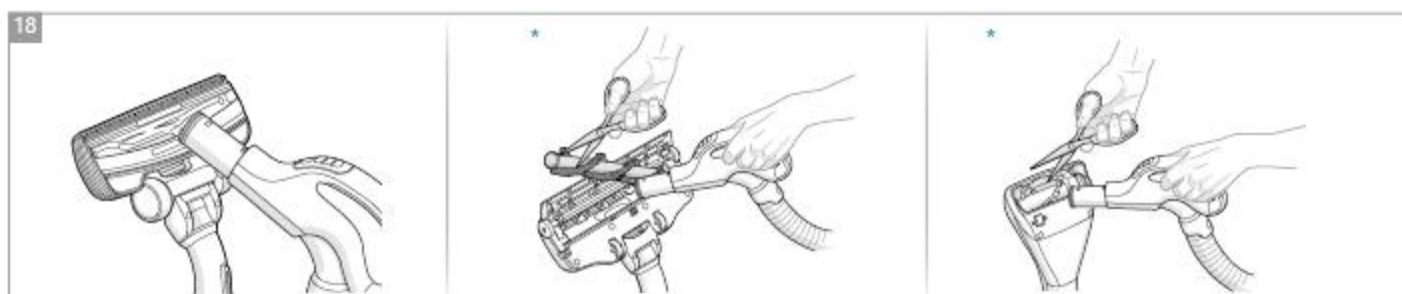

7. KIỂM TRA HỆ THỐNG

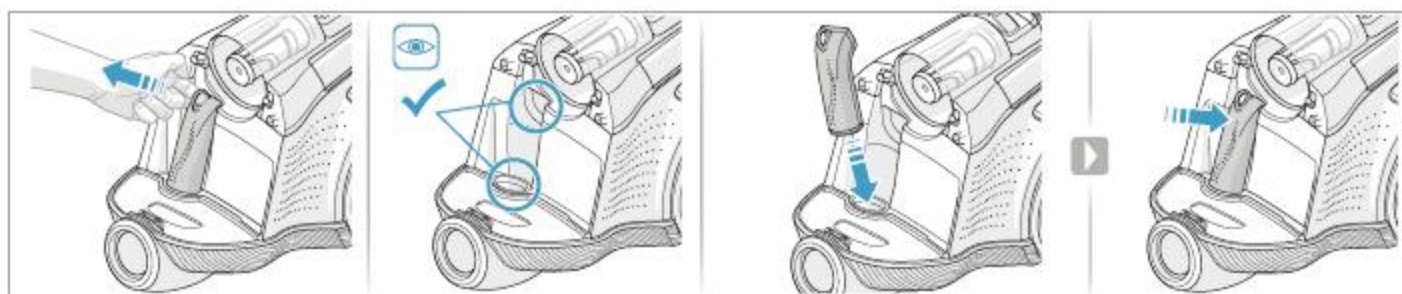
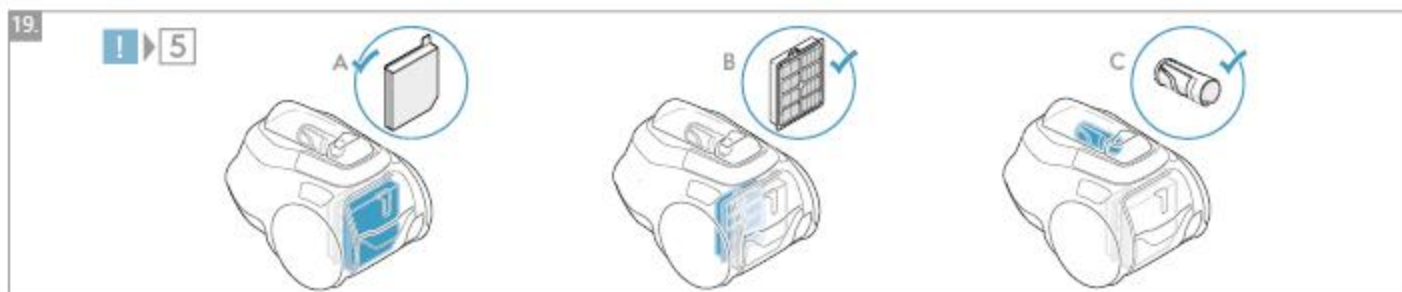

CÁC BIỆN PHÁP ĐỂ PHÒNG VI SỰ AN TOÀN

Trẻ em từ 8 tuổi trở lên và người bị suy giảm thể chất, giác quan, thiếu năng trí tuệ hoặc thiếu kinh nghiệm và kiến thức có thể sử dụng thiết bị này nếu họ được giám sát hoặc hướng dẫn sử dụng an toàn và hiểu những mối nguy hiểm có thể xảy ra.

Trẻ em phải được giám sát để đảm bảo chúng không nghịch phá thiết bị này.

Trẻ em không được tiến hành công việc vệ sinh và bảo trì nếu không có người giám sát.

CẢNH BÁO: Đầu hút tuabin* có chổi xoay trong đó, các bộ phận có thể bị mắc kẹt. Vui lòng sử dụng các đầu hút này thận trọng và chỉ dùng trên các bề mặt dự kiến sử dụng. Vui lòng tắt máy hút bụi trước khi tháo các bộ phận mắc kẹt hoặc làm vệ sinh chổi.

Bạn phải tháo pin khỏi điều khiển từ xa trong tay cầm* / đầu hút có đèn LED* trước khi loại bỏ sản phẩm này**.

* Chỉ có ở một số model.

** Thông tin về cách tháo pin nằm trong phần 6 và 7.

Luôn rút phích cắm ra khỏi nguồn điện trước khi vệ sinh hay bảo trì thiết bị hoặc khi tháo pin. Pin cần được thải loại an toàn.

Nếu dây điện bị hỏng, phải thay dây này tại trung tâm dịch vụ được ủy quyền của Electrolux để tránh nguy hiểm.

Pure C9 chỉ nên được sử dụng để hút bụi thông thường trong nhà và trong môi trường sinh hoạt gia đình. Hãy đảm bảo cất giữ máy hút bụi ở nơi khô thoáng.

Tất cả dịch vụ hoặc công việc sửa chữa phải do trung tâm dịch vụ được ủy quyền của Electrolux tiến hành.

Trẻ em không được tiếp cận các vật liệu đóng gói như túi nhựa để tránh nguy cơ bị nghẹt thở.

Tuyệt đối không sử dụng máy hút bụi:

Ở khu vực ẩm ướt.

Gần các khí dễ cháy...

Khi thiết bị xuất hiện các dấu hiệu hư hỏng có thể nhìn thấy.

Trên đồ vật sắc nhọn hoặc chất lỏng.

Khi đầu hút sản xuất hiện các dấu hiệu hư hỏng có thể nhìn thấy.

Trên xi than nóng hoặc nguội, đầu tàn thuốc lá.

Trên lớp bụi mịn, ví dụ từ thạch cao, xi măng, bột, tro nóng hoặc nguội.

Không để máy hút bụi trực tiếp dưới ánh nắng mặt trời.

Tránh để máy hút bụi tiếp xúc với hơi quá nóng hoặc nhiệt độ đóng băng.

Tuyệt đối không sử dụng máy hút bụi mà không lắp màng lọc.

Không cố chạm vào con lăn trong chổi khi máy hút bụi đang bật và khi con lăn trong chổi đang xoay.

Khi bánh xe bị mắc kẹt.

Không sử dụng máy hút bụi nếu màng lọc bị hỏng hoặc rách.

Biện pháp để phòng với dây điện

Thường xuyên kiểm tra phích cắm và dây điện. Tuyệt đối không sử dụng máy hút bụi nếu phích cắm hoặc dây điện bị hỏng.

Trường hợp hư hỏng đối với dây điện của máy hút bụi không được bảo hành. Tuyệt đối không kéo hoặc nhấc máy hút bụi lên bằng dây điện.

Sử dụng máy hút bụi trong những trường hợp trên có thể gây thương tích nghiêm trọng về người hoặc làm hỏng nặng sản phẩm. Những trường hợp thương tích hoặc hư hỏng này không được bảo hành và Electrolux không có trách nhiệm phải xử lý.

DỊCH VỤ VÀ BẢO HÀNH

Tất cả dịch vụ hoặc công việc sửa chữa phải do trung tâm dịch vụ được ủy quyền của Electrolux tiến hành.

Trường hợp hư hỏng đối với dây điện của máy hút bụi không được bảo hành. Trường hợp hư hỏng đối với động cơ do hút chất lỏng, nhưng thiết bị vào chất lỏng hoặc sử dụng thiết bị khi ống mềm và đầu hút bị hỏng không được bảo hành.

THẢI LOẠI



Biểu tượng này trên sản phẩm cho biết sản phẩm này có pin không được phép thải loại cùng với rác thải sinh hoạt thông thường.



Biểu tượng này trên sản phẩm hoặc trên bao bì sản phẩm cho biết không được xử lý sản phẩm này như rác thải sinh hoạt.

Để tái chế sản phẩm của bạn, vui lòng đưa sản phẩm đến một điểm thu gom chính thức hoặc trung tâm dịch vụ của Electrolux có thể tháo và tái chế pin cũng như các bộ phận điện một cách an toàn và chuyên nghiệp. Hãy tuân thủ các quy định về thu gom riêng sản phẩm chạy điện và pin sạc ở quốc gia bạn.

Bảng văn bản này, Electrolux Home Care and SDA tuyên bố rằng Máy hút bụi này với loại thiết bị vô tuyến FOR1, FOR2 và FOR3 tuân thủ Chỉ thị 2014/53/EU.

TIẾNG ANH

Cảm ơn bạn đã lựa chọn máy hút bụi Pure C9 của Electrolux. Hãy luôn sử dụng các phụ kiện và phụ tùng chính hãng để thu được kết quả tốt nhất. Sản phẩm này được thiết kế có cân nhắc tới yếu tố bảo vệ môi trường. Tất cả các bộ phận bằng nhựa được đánh dấu để phục vụ mục đích tái chế.

TRƯỚC KHI BẮT ĐẦU, HÃY

- Đọc hướng dẫn này cẩn thận.
- Kiểm tra để đảm bảo bạn có tất cả các bộ phận được mô tả.
- Đặc biệt chú ý tới các biện pháp để phòng vi sự an toàn!

MÔ TẢ VỀ MÁY HÚT BỤI PURE C9

- | | |
|---|---|
| A. Màn hình A1 Nút xoay điều khiển* A2 Điều khiển từ xa* | Phụ kiện đầu hút K. Công cụ 3 trong 1 AeroPro T. Đầu hút mô-tơ chổi xoay* U. Đầu hút FlowMotion* V. Đầu hút FlowMotion LED (có đèn phía trước)* W. Đầu hút tuabin AeroPro* X. Đầu hút tuabin AeroPro Mini* Y. Đầu hút ParkettoPro* Z. Đầu hút AeroPro FlexProPlus* AA. Đầu hút khe nhỏ và dài AeroPro* AB. Đầu hút BedPro* |
| B. Nắp màng lọc C. Màng lọc bụi mịn D. Màng lọc trước động cơ E. Khe đựng máy F. Dây điện G. Quai xách H. Khoảng lốc xoay và màng lọc trên chóp I. Kênh dẫn khí J. Khoảng chứa bụi L. Ống mềm AeroPro M. Tay cầm AeroPro M1 Tay cầm AeroPro Classic* M2 Tay cầm AeroPro Ergo* M3 Tay cầm Điều khiển từ xa AeroPro* | * Chỉ có ở một số model |
| N. Ống lồng AeroPro O. Kẹp đựng máy | |

Trang hình ảnh 2-6

CÁCH SỬ DỤNG MÁY HÚT BỤI

- 1 Kiểm tra để đảm bảo rằng tất cả các màng lọc đã được lắp đúng vị trí trước khi sử dụng máy hút bụi.
- 2 Cắm ống mềm vào máy hút bụi (để tháo ống này, hãy nhấn các nút khóa và kéo). Cắm ống mềm vào tay cầm ống mềm tới khi có tiếng tách của nút khóa (để tháo ống này ra, hãy nhấn nút khóa và kéo).
- 3 Lắp ống lồng vào đầu hút. Lắp ống lồng vào tay cầm ống mềm (để tháo ống lồng, hãy nhấn nút khóa và kéo).
- 4 Điều chỉnh ống lồng bằng cách giữ khóa một tay còn tay kia kéo tay cầm.

CÔNG CỤ 3 TRONG 1

- 5 Bạn có thể siết chặt tay cầm có kẹp và công cụ 3 trong 1 bên dưới tay cầm để dễ dàng tiếp cận. Công cụ này có 3 chức năng, xem hình ảnh ở trang sau.

THAY PIN*

- 6 Đầu hút có đèn phía trước*: Trước khi sử dụng lần đầu, hãy tháo lớp màng bảo vệ (ở phía trên pin). Thay pin khi đèn phía trước bắt đầu nhấp nháy nhanh. Dùng 2 pin AA.
- 7 Tay cầm có điều khiển từ xa*: Thay pin khi đèn báo chuyển sang màu đỏ hoặc không phản hồi khi nhấn bất kỳ nút nào. Chỉ dùng loại pin LITHIUM CR1632.

Đặc biệt chú ý: Tháo pin khỏi sản phẩm trước khi loại bỏ. Hãy tuân thủ các quy định về việc thu gom pin và sản phẩm chạy điện ở quốc gia bạn.

KHOẢNG DỪNG/DỪNG MÁY HÚT BỤI VÀ ĐIỀU CHỈNH CÔNG SUẤT HÚT

- 8 Kéo dây điện ra và cắm vào nguồn điện. Nhấn nút ON/OFF để bật/tắt máy hút bụi. Các model có điều khiển từ xa cũng có thể vận hành bằng nút ON/OFF trên tay cầm.*
- 9 Sau khi vệ sinh, ấn nút REWIND để thu dây lại.
- 10 Điều chỉnh công suất hút (model điều khiển thủ công): Bật nút xoay trên máy hút bụi hoặc dùng van khí trên tay cầm.*
Điều chỉnh công suất hút (model điều khiển từ xa): Nhấn nút +/- trên tay cầm. Đèn báo MIN/MAX và biểu tượng trên màn hình sẽ hiển thị mức công suất.*

HÚT BỤI BẰNG ĐẦU HÚT ĐA NĂNG (V*, W*)

- 11 Thay đổi chế độ đầu hút bằng bàn đạp. Biểu tượng minh họa loại sàn khuyến nghị (sàn cứng hoặc thảm).
Đầu hút FlowMotion LED*: Di chuyển đầu hút về phía trước. Đèn phía trước tự động bật sau vài giây. Khi không dùng đầu hút, đèn tự động tắt sau vài giây.
- 12 Sử dụng vị trí dựng máy (1), ở phía sau máy hút bụi, khi bạn tạm dừng máy trong khi đang hút bụi. Sử dụng vị trí dựng máy (2), bên dưới máy hút bụi, để di chuyển và cất giữ máy hút bụi.
- 13 Máy hút bụi có 2 quai xách.

LÀM SẠCH KHOANG CHỨA BỤI

- 14 Làm sạch khoang chứa bụi khi lượng bụi trong khoang đạt giới hạn tối đa (đầu "MAX").
Nhấn nút nhà và kéo để tháo khoang chứa bụi.
Giơ khoang chứa bụi lên trên thùng rác. Nhấn nút mở khóa bên dưới nắp, mở nắp bằng cách kéo nắp ra phía ngoài. Đổ bụi vào thùng rác. Lắp lại theo trình tự đảo ngược.

THAY THẾ MÀNG LỌC

- 15 Kéo nút FILTER để mở nắp màng lọc.
Vệ sinh màng lọc bụi mịn sau khi sử dụng 6 tháng hoặc khi bạn nhìn thấy bụi. Kéo gờ trên khung để tháo màng lọc bụi mịn. Rửa sạch màng lọc dưới vòi nước chảy.
Đặc biệt chú ý: Không dùng xà phòng hay chất tẩy rửa. Hãy để màng lọc khô hẳn (tối thiểu trong 24 giờ ở nhiệt độ phòng) trước khi lắp lại!
- 16 Nhấn và trượt khóa sang phải để nhà màng lọc trước động cơ. Tháo màng lọc bằng cách kéo gờ trên khung màng lọc.
Vệ sinh màng lọc trước động cơ sau khi sử dụng 12 tháng.
Chỉ sử dụng màng lọc s-filter chính hãng được Electrolux Khuyến nghị (xem phần Vật tư tiêu hao và phụ kiện). Rửa sạch bên trong (mặt bên) bằng nước ấm chảy từ vòi. Vỗ lên khung màng lọc cho ráo nước. Lắp lại quy trình này 4 lần.
Đặc biệt chú ý: Không dùng xà phòng hay chất tẩy rửa. Tránh chạm vào bề mặt màng lọc. Hãy để màng lọc khô hẳn (tối thiểu trong 24 giờ ở nhiệt độ phòng) trước khi lắp lại! Thay màng lọc có thể giặt tối thiểu mỗi năm một lần hay khi màng lọc bị bẩn hoặc hư hỏng.
Sau khi thay thế màng lọc, đóng nắp màng lọc tới khi màng lọc khớp lại đúng vị trí.
- 17 Vệ sinh màng lọc trên chóp: màng lọc trên chóp nằm trong khoảng lốc xoay. Hãy vệ sinh màng lọc trên chóp nếu có bụi chui vào. Kéo màng lọc trên chóp để tháo. Làm sạch bụi bằng tay. Vệ sinh dưới vòi nước chảy nếu có nhiều bụi bẩn. Lắp lại theo trình tự đảo ngược.
Đặc biệt chú ý: Không dùng xà phòng hay chất tẩy rửa. Hãy để màng lọc khô hẳn (tối thiểu trong 24 giờ ở nhiệt độ phòng) trước khi lắp lại!









VỆ SINH ĐẦU HÚT ĐA NĂNG (V*, W**) VÀ ĐẦU HÚT TUABIN (X*)

- 18 Tháo đầu hút đa năng ra khỏi ống lồng. Vệ sinh bằng tay cầm ống mềm.
Tháo đầu hút tuabin ra khỏi ống lồng và loại bỏ các sợi dây bị vướng vào bằng cách dùng kéo cắt. Sử dụng tay cầm ống mềm để vệ sinh đầu hút.*

Chúc bạn có trải nghiệm tuyệt vời khi hút bụi bằng Pure C9!

Electrolux bảo lưu quyền thay đổi sản phẩm, thông tin và thông số kỹ thuật mà không cần thông báo.

MẸO KHAI THÁC KẾT QUẢ TỐT NHẤT

| ĐẦU HÚT/PHỤ KIỆN | DÙNG CHO: | ĐẦU HÚT/PHỤ KIỆN | DÙNG CHO: |
|---|--|--|--|
| T. Đầu hút mô-tơ chổi xoay*  | Đầu hút thảm: - Đầu hút mô-tơ chổi xoay giúp hút bụi tốt nhất và vệ sinh sạch các tấm thảm bằng con lăn chổi xoay quay đều trên thảm. - Không bật con lăn của chổi khi Đầu hút mô-tơ chổi xoay không di chuyển. | U. Đầu hút FlowMotion* V. Đầu hút FlowMotion LED*  | Đầu hút đa năng: - Dùng cho tất cả các loại sàn, đảm bảo thu gom bụi hiệu quả nhất trên cả thảm lẫn sàn cứng. - Thay đổi chế độ đầu hút bằng bàn đạp. Biểu tượng sẽ hiển thị loại sàn khuyến nghị. - Đèn phía trước giúp phát hiện bụi bẩn trong không gian tối tăm (dưới gầm đồ vật...). <i>Chỉ có ở PureVision</i> |
| | | X. Đầu hút tuabin mini*  | Đầu hút bề mặt vải: - Quét và hút đồng thời (thu gom tóc, sợi vải... hiệu quả nhất). - Dùng cho đồ vật bằng vải, ghế xe hơi, nệm... - Con lăn trong chổi được điều khiển bằng dòng khí của máy hút bụi. - Không phù hợp với thảm có sợi lông và tua rua dài vì chúng có thể mắc kẹt vào con lăn trong chổi xoay. |
| W. Đầu hút tuabin*  | Đầu hút thảm: - Quét và hút đồng thời (thu gom tóc, sợi vải... hiệu quả nhất). - Con lăn trong chổi được điều khiển bằng dòng khí của máy hút bụi. - Không phù hợp với thảm có sợi lông và tua rua dài, thảm chống trượt như thảm ở cửa hoặc thảm chống thấm nước. Với các thảm này, hãy dùng đầu hút đa năng. | Z. Đầu hút FlexProPlus*  | Đầu hút sàn cứng: - Để tiếp cận không gian dưới hoặc giữa các đồ vật, khu vực trong góc hoặc những không gian khó tiếp cận khác. - Có thể xoay 180 độ để dàng để tiếp cận trực tiếp những không gian chật hẹp. |
| Y. Đầu hút ParkettoPro*  | Đầu hút sàn cứng: - Để vệ sinh nhẹ nhàng trên sàn cứng (sàn bằng gỗ hoặc lát gỗ, gạch...). - Thu gom bụi hiệu quả nhất trên sàn cứng có khe nhỏ. | AB. Đầu hút BedPro*  | Đầu hút BedPro: - Loại bỏ các hạt bụi bẩn từ chăn ga gối đệm. |
| AA. Đầu hút khe nhỏ và dài*  | Công cụ nối dài: - Dùng cho những khu vực khó tiếp cận (đỉnh giá sách...). - Dùng cho không gian nhỏ hẹp (phía sau lò sưởi, dưới ghế xe hơi...). | K. Công cụ 3 trong 1*  | 3 công cụ trong 1: 1. Công cụ làm sạch bụi trên bề mặt cứng (giá sách, gạch/gỗ ốp chân tường...) 2. Công cụ làm sạch bụi trên đồ vải (rèm, nệm...) 3. Công cụ dành cho khe nhỏ trong không gian chật hẹp (phía sau lò sưởi...). |

Model có tính năng điều chỉnh công suất thủ công
 - làm theo hình vẽ trên máy hút để đạt hiệu quả tối ưu.

KHẮC PHỤC SỰ CỐ

| SỰ CỐ | GIẢI PHÁP |
|--|---|
| Máy hút bụi không khởi động | <ul style="list-style-type: none"> • Kiểm tra để đảm bảo rằng dây điện được kết nối với nguồn điện. • Kiểm tra để đảm bảo rằng phích cắm và dây điện không hư hỏng. • Kiểm tra xem cầu chì có bị ngắt. • Kiểm tra xem đèn báo pin trong tay cầm điều khiển từ xa có phản hồi không (chỉ có ở một số model). |
| Máy hút bụi dừng hoạt động | Máy hút bụi có thể bị quá nóng: hãy ngắt kết nối nguồn điện của máy; kiểm tra xem đầu hút, ống lồng, ống mềm hoặc màng lọc có bị tắc nghẽn không. Để máy hút bụi nguội dần trong 120 phút trước khi cắm máy trở lại. Nếu máy vẫn không hoạt động, hãy liên hệ với trung tâm dịch vụ được ủy quyền của Electrolux. |
| Giảm công suất hút so với bình thường | <ul style="list-style-type: none"> • Kiểm tra xem khoang chứa bụi có bị đầy hay tắc nghẽn không. • Kiểm tra xem kênh dẫn khí và các đầu nối khí ra hoặc vào xem có bị tắc nghẽn và cần vệ sinh không. • Kiểm tra xem màng lọc phía trước động cơ có bị tắc và cần thay không. • Kiểm tra xem đầu hút có bị tắc nghẽn và cần vệ sinh không. • Kiểm tra xem ống mềm có bị tắc nghẽn không bằng cách ép nhẹ ống. Tuy nhiên, hãy cẩn thận để phòng trường hợp tắc nghẽn do mảnh thủy tinh hoặc kim mắc kẹt bên trong ống mềm. Lưu ý: Chế độ bảo hành không áp dụng cho bất kỳ trường hợp hư hỏng nào ở ống mềm do việc vệ sinh ống mềm gây ra. |
| Nước bị hút vào bên trong máy hút bụi | Cần thay thế động cơ ở trung tâm dịch vụ được ủy quyền của Electrolux. Trường hợp hư hỏng đối với động cơ do nước xâm nhập không được bảo hành. |
| Đối với bất kỳ sự cố nào khác, hãy liên hệ với trung tâm dịch vụ được ủy quyền của Electrolux. | |

VẬT TƯ TIÊU HAO & PHỤ KIỆN



Mua Vật tư tiêu hao & phụ kiện cho thiết bị của bạn:

www.electroluxshop.co.kr
<https://shop.electrolux.com.au/>

Khả năng cung ứng Vật tư tiêu hao & phụ kiện thay đổi theo khu vực và quốc gia.
 Vui lòng tham khảo trang web Electrolux địa phương của chúng tôi để biết thêm chi tiết hoặc liên hệ với đường dây nóng về dịch vụ khách hàng địa phương để được trợ giúp.

S-FILTER



PureAdvantage D11 Washable
 (Australia, New Zealand)

HEPA 13 washable

S-FRESH



Crispy Bamboo
 Tropical Breeze
 Brown Sugar & Fig
 Evening Rose
 Citrus Burst

ĐẦU HÚT*



Silent Parketto



DustMagnet Silent

BỘ PHỤ KIỆN



Delicate Care KIT



Clean & Tidy KIT

* Khả năng cung ứng phụ kiện phụ thuộc vào kích thước ống lồng

DỊCH VỤ VÀ CHĂM SÓC KHÁCH HÀNG

Khi liên hệ với bộ phận Dịch vụ, hãy đảm bảo bạn có sẵn các dữ liệu sau:

- Số model
- Số PNC
- Số sê-ri

Bạn có thể tìm thấy các thông tin này trên nhãn máy.

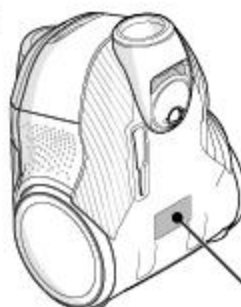

| Số model | Số PNC | Số sê-ri |
|---|------------------|-----------------------------------|
| | | |
| Model Code TBD | PNC 910287894 | Typ FNA Serial No. 12345678 |
| | | 230 V 50 Hz 550 W NCM |
| | | |
| <small>Electrolux Appliances AB S-1 Göranssonsgatan, 40 SE-100 49 Stockholm, Sweden</small> | | |

HÃY TRUY CẬP TRANG WEB CỦA CHÚNG TÔI ĐỂ:



Được tư vấn cách sử dụng, thông tin sản phẩm,
 cách xử lý sự cố và thông tin dịch vụ tại:
www.electrolux.com

ELECTROLUX OFFICE ADDRESS

中国

伊莱克斯（中国）电器有限公司 上海小家电分公司
中国，上海，静安区共和新路1968号大宁国际广场
8号楼606室

办公电话: +86 21 3178 1000

传真: +86 21 3387 0368

售后服务: +86 9510 5801

服务邮箱: saservice.china@electrolux.com

网站: www.electrolux.com.cn

售后服务微信公众号:



台灣

新加坡商伊莱克斯股份有限公司 台灣分公司
22065新北市板橋區縣民大道2段68號9F

免付費客專專線: 0800-888-259

傳真: 886-2-8964-5269

電郵: service@electrolux.com.tw

網站: www.electrolux.com.tw

KOREA

일렉트로룩스 코리아(주)

서울특별시 중구 을지로100

파인애비뉴빌딩 8층 9층 (우: 04551)

고객센터: 1566-1238

팩스: +(82) 2 6020-2271-3

이메일: homecare.krh@electrolux.com

웹사이트: www.electrolux.co.kr

역세서리구매: www.electroluxshop.co.kr

INDONESIA

PT. Electrolux Indonesia

Electrolux Building

Jl. Abdul Muis no. 34, Petojo Selatan,

Gambir, Jakarta Pusat 10160,

Tel: +(62) 21 5081 7300

Fax: +(62) 21 5081 7399

Customer Care Services: +(62) 0804 111 9999

Email: customercare@electrolux.co.id

Website: www.electrolux.co.id

DEPDAG: I.31.EI6.00334.0119

PHILIPPINES

Electrolux Philippines Inc.

12th Floor, Cyber Sigma Building

Lawton Avenue

McKinley West

Taguig, Philippines 1634

Tel: +(63) 2 737 4757

Domestic Toll Free: 1 800 10 845-care (2273)

Customer Care Services: +(63) 2 845-care (2273)

Email: wecare@electrolux.com

Website: www.electrolux.com.ph

THAILAND

Electrolux Thailand Co Ltd

Electrolux Building

14th Floor 1910 New Petchburi Road

Bangkaep, Huay Kwang

Bangkok 10310

Thailand

Tel: +(66) 2 725 9100

Fax: +(66) 2 725 9299

Customer Care Services: +(66) 2 725 9000

Email: customercarethai@electrolux.com

Website: www.electrolux.co.th

VIETNAM

Electrolux Vietnam Ltd

Floor 9th, A&B Tower

76 Le Lai Street

Ben Thanh Ward - District 1

Ho Chi Minh City

Vietnam

Tel: +(84) 8 3910 5465

Fax: +(84) 8 3910 5470

Customer Care Services: 1800-58-8899

Email: vncare@electrolux.com

Website: www.electrolux.vn

MALAYSIA

Electrolux Home Appliances Sdn Bhd

Lot C6, No. 28, Jalan 15/22,

Taman Perindustrian Tiong Nam,

40200 Shah Alam, Selangor

Malaysia

Customer Care Hotline: 1300-88-11-22

Customer Care Services Tel: +(60 3) 5525 0800

Customer Care Services Fax: +(60 3) 5524 2521

Email: malaysia.customercare@electrolux.com

Website: www.electrolux.com.my

SINGAPORE

Electrolux SEA Pte Ltd

1 Fusionopolis Place, Galaxis #07-10 (West Lobby)

Singapore 138522

Customer Care Hotline: +(65) 6727 3699

Fax: +(65) 6727 3611

Email: customer-care.sn@electrolux.com

Website: www.electrolux.com.sg

HONG KONG

大昌貿易行有限公司

電器維修中心

香港九龍灣啟祥道20號

大昌行集團大廈5樓

服務熱線: +(852) 3193 9888

電子郵件: dthead@ead.dch.com.hk

網頁: www.electrolux.com.hk

AUSTRALIA

Electrolux Home Care & Small Domestic Appliances

ABN 51 004 762 341

163 O'Riordan Street, Mascot, NSW 2020, Australia

Customer Service Phone: 1300 365 305

Website: www.electrolux.com

NEW ZEALAND

Electrolux Home Care & Small Domestic Appliances

A division of Electrolux (NZ) Limited

3-5 Niall Burgess Road, Mt Wellington,

Auckland, New Zealand

Phone: (09) 573 2220

Customer Service Phone: 0508 730 730

Website: www.electrolux.com